



# **KOBELCO**

---

## **WELDING HANDBOOK**

**KOBE STEEL, LTD.**

**WELDING BUSINESS**



# Overall Index



• For your further information of welding consumable specifications, classifications, approvals and packages, please contact the nearest Kobelco office or sales representative.

# Notification

---

We, Welding Business of Kobe Steel, Ltd., thank you very much for your continuous patronage of our products and services. We have changed the designation system of welding consumable as described in the following since April 2008. However, the technical design of the products is not changed.

## Our group brand names and the corresponding products

All KOBELCO welding consumables are designated with “Trade Designation” and are grouped into the following three groups on the basis of the characteristics of individual products as detailed below.

- (1) **FAMILIARC™** (Famili-Arc)  
A coined word produced by combining “Familiar” and “Arc.”  
Welding consumables grouped into this group are used for general welded structures made of mild steels and high tensile strength steels that have the tensile strength of less than 590 MPa.

- (2) **TRUSTARC™** (Trust-Arc)  
A coined word produced by combining “Trust” and “Arc.”  
Welding consumables grouped into this group are used for such steels that require highly credible qualities as high tensile strength steels with the tensile strength of 590 MPa and higher, low temperature steels, and heat-resistant low-alloy steels.

- (3) **PREMIARC™** (Premi-Arc)  
A coined word produced by combining “Premium” and “Arc.”  
Welding consumables grouped into this group are used for high-alloy steels, stainless steels, and nonferrous metals.

Our group brand name (referred to as “Trademark” hereinafter) is put on the head of an individual trade designation. The trade designations are made by modifying the traditional brand names in accordance with our designation system in which the position of hyphen is reviewed so that a hyphen comes after one letter or two letters. That is, Our brand name consists of “Trademark” and “Product name” as shown in the following. We are determined to control all the trade designations so that they can clearly be identified.

Examples of our current and previous brand names

Previous Brand Name	Current Brand Name
(1) B-10	<b>FAMILIARC™</b> B-10
(2) MG-50	<b>FAMILIARC™</b> MG-50
(3) TGS-50	<b>FAMILIARC™</b> TG-S50
(4) MGS-50	<b>FAMILIARC™</b> MG-S50
(5) ZERODE-44	<b>FAMILIARC™</b> Z-44
(6) CMA-106N	<b>TRUSTARC™</b> CM-A106N
(7) DW-308	<b>PREMIARC™</b> DW-308

## The purpose of our designation system

In recent years, we have found some other companies' products that have the same brand names as ours and false certificates that misrepresent our company's certificates in Japan and the Asian countries.

In order to cope with this problem, we have taken legal actions against the impostors that could be verified and have required them to change their product names. However, it is difficult in the traditional product designation system to protect all of our products from imitation. Hence, we have established the current designation system of welding consumable to ensure the trademark right in main countries and to make our products identifiable more clearly, in which the particular group brand name, "Trademark," is put on the head of an individual "Product name."

Our designation system is not only to prevent counterfeit products in Japan and overseas countries, but also to prevent our customers and users from suffering such a trouble in terms of our products.

This modification may have caused customers and users to modify their relevant documents. We sincerely hope for your understanding of the abovementioned situation and for your cooperation with us.

## Introduction to our Home page



<http://www.kobelco.co.jp/english/welding>



<http://www.kobelco-welding.jp/index>



search words

kobelco, english, welding



search words

welding wire, welding robot,  
kobelco

# Foreword

---

Note the following preliminary information on use of this welding handbook.

## 1. Standards for welding consumables

AWS : American Welding Society  
EN : European Norm

## 2. Classifications

Welding consumables are classified in accordance with basically the mechanical and/or chemical requirements of the standards, excluding such requirements as size, length, marking and identification manners.

## 3. The test conditions

- (1) Unless otherwise specified, the testing method and condition are as per AWS standard.
- (2) All mechanical and chemical data are given separately as “Typical” (one of the manufacturer’s test data) and “Guaranty” (the guaranty value).
- (3) Unless otherwise specified, all mechanical test are carried out in the as-welded condition.

## 4. Packaging data

Packaging data shows product length, and mass, the approximate volume.

## 5. Welding parameters

Welding parameters indicates the recommended current range of each welding position.

## 6. Approvals

We have displayed the certification of the grade of classification society of the time in December, 2019.

They may be cancelled, added, or changed and may not necessarily be applied to all the welding consumables produced at the production plants of Kobe Steel. Therefore, please contact with Global Operations & Marketing Dept. of the Welding Business of Kobe Steel when you need the ship classification approval of a particular welding consumable to be used. Ship classification approvals are available at our website ; <https://kobelco-welding.jp/company/certification>

[Ship classification societies]

ABS: American Bureau of Shipping LR: Lloyd’s Register of Shipping

DNV: Det Norske Veritas and Germanischer Lloyd

BV: Bureau Veritas NK: Nippon Kaiji Kyokai CR: Central Research of Ships S. A.

KR: Korean Register of Shipping CCS: China Classification Society

## DISCLAIMER

- Information in this catalogue such as chemical compositions and mechanical properties is typical or example for explaining the features and performance of our products, and it does not guarantee otherwise specified.
- Information contained herein is subject to change without notice. Please kindly contact KOBELCO for latest information.

## 7. Welding position

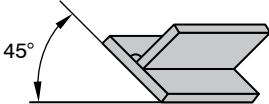
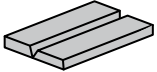
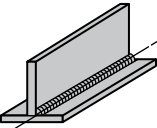
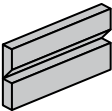
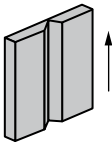
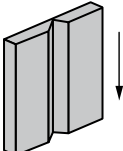
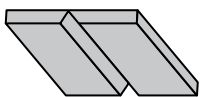
Illustration	AWS A3.0	ISO 6947
	1F	PA
	1G	PA
	2F	PB
	2G	PC
	3G uphill	PF
	3G downhill	PG
	4G	PE

# Abbreviations and marks

This welding handbook uses the following abbreviations and marks if necessary.

<b>Abbrev. and mark</b>	<b>Definition</b>	<b>Abbrev. and mark</b>	<b>Definition</b>
AC	Alternating current or Air cooling	L	Length
A	Ampere	MS	Mild steel
AP	All positions	NR	Not required
AW	As-welded	Pre. H	Preheat
Bal	Balance	PWHT	Postweld heat treatment
CR	Cooling rate	RC	Redrying conditions
DC	Direct current	RT	Room temperature
DCEN	DC, electrode negative	SAW	Submerged arc welding
DCEP	DC, electrode positive	SG	Shielding gas
Dia.	Diameter	SMAW	Shielded metal arc welding
EGW	Electrogas arc welding	SR	Stress relief
EI	Elongation	SW	Solid wire
FCW	Flux-cored wire	TIG	Tungsten inert gas
FCAW	Flux Cored Arc Welding	TS	Tensile strength
GMAW	Gas Metal Arc Welding	V	Voltage
GTAW	Gas Tungsten Arc Welding	W	Width
H	Height	WP	Welding position
HAZ	Heat-affected zone	[F]	FAMILIARC™
HI	Heat input	[T]	TRUSTARC™
HT	High tensile	[P]	PREMIARC™
Hv	Hardness (Vickers)		
IPT	Interpass temperature		
IV	Impact value		



# Warning and Caution in Welding

Pay your attention to the following warnings and cautions for your safety and health during welding and related operations



## WARNING

**Be sure to follow safety practices stated in the following in order to protect welders, operators and accompanied workers from a serious accident resulting in injury or death.**

- Be sure to follow safety practices stated in the following when you use welding consumables.
- Be sure to follow safety practices stated in the instruction manual of welding equipment when you use it.
- Prior to use, please read and understand SDS, the manufacturer's instructions, and the precautionary labels.  
SDS can be found in KOBELCO Website.  
<https://www.kobelco.co.jp/english/welding/sds/>



## WARNING



**Electric shock can kill.**

- Do not touch live electrical parts (A stick electrode held with an electrode holder and a welding wire are electrically live).
- Wear dry, insulated gloves. Do not wear torn or wet gloves. Use an electric shock preventing device (e.g., open-circuit-voltage-reducing device) when welders or operators work in confined or high-level spaces. Use also a lifeline when welders or operators conduct welding at a high-level space.
- Follow safety practices stated in the instruction manual of welding machines before use. Do not use a welding machine the case or cover of which is removed. Welding cables must have an adequate size for the capacity expected. Welding cables must be kept in an appropriate condition and a damaged cable must be repaired or replaced with new one.



## CAUTION



**Flying spatter and slag can injure eyes and cause skin burns.**

**High temperature heat of welding can cause skin burns.**

- Wear safety glasses, safety leather gloves for welding, long sleeve shirts, foot covers, leather aprons, etc.
- Do not touch weldments while they are hot.



## CAUTION



**Fumes and gases generated during welding are dangerous to your health.**

**Welding in confined spaces is dangerous because it can be a cause to suffocation by oxygen deficient.**

- Keep your head out of the source of fumes or gases to prevent you from directly breathing high density fumes or gases.
- Use local exhaust ventilation, or wear respirators in order to prevent you from breathing fumes and toxic gases which cause toxication, poor health and suffocation by oxygen deficient.
- Use general ventilation during welding in a workshop. Particularly during welding in confined spaces, be sure to use adequate ventilation or respirators, and welding should be done at the presence of a trained supervisor.
- Do not conduct welding at where degreasing, solvent cleaning, spraying, or painting operations are carried out nearby. Welding work accompanied by these operations may cause generation of harmful gases.
- Use adequate ventilation or respirators with special attention during welding plated and coated steels.
- Use respirators, eye safety glasses and safety leather gloves when using welding fluxes in order to prevent you from flux dust.



## CAUTION



**Arc rays can injure eyes and burn skin.**

- Wear hand shields with an adequate shade grade during welding operations and supervising the welding work. Select the correct shade grade for filter lenses and filter plates suitable for exact welding work by referring the standard JIS T 8141.
- Wear suitable protectors for protecting you from an arc ray; e.g., safety leather glove for welding, long sleeve shirt, foot cover, leather apron.
- Use, at need, shade curtains for welding by surrounding the welding areas in order to prevent accompanied workers from arc rays.



## CAUTION



**The tip of a welding wire and filler wire can injure eyes, faces, etc.**

- When take off the tip of a wire fastened in the spool, be sure to hold the tip of the wire.
- When check the wire feeding condition, do not direct the welding torch to your face.



## CAUTION



**Fire and explosion can take place.**

- Never conduct welding at areas adjacent to highly inflammable materials. Remove combustibles so that spatters cannot ignite them. If combustibles cannot be removed, cover them with a noninflammable material.
- Do not weld vessels or pipes which contain combustibles or being sealed.
- Do not put a hot weldment close to combustibles right after welding finished.
- When welding ceilings, floors, walls, remove combustibles put at the other side of them.
- Any part of a welding wire, with exception of the portion appropriately extended from the tip of the torch, must be free from touching the electrical circuit of the base metal side.
- Fasten cable joints and seal them with an insulation tape. The cable of the base metal side should be connected as close as possible to the welding portion of the work.
- Prepare fire-extinguishing equipment at where welding is carried out, in order to cope with a possible accident.



## CAUTION



**Falling down or dropping welding consumables can injure you.**

- Wear safety shoes and pay your attention not to drop welding consumables on your body when carrying and handling them. Keep yourself in a correct posture not to cause a crick in your back while handling them.
- Follow the handling instructions shown on the surface of the drum wire packages when handle them.
- Pile up welding consumables in a correct way so as not to cause falling or dropping while they are stored or carried.



## WARNING

**These products can expose you to chemicals including Nickel and Titanium Dioxide, which are known to the State of California to cause cancer, and Chromium, which is known to the State of California to cause cancer and birth defects or other reproductive harm. For more information go to [www.P65Warnings.ca.gov](http://www.P65Warnings.ca.gov).**

- Please refer to SDS before use. SDS is available on KOBELCO website. <https://www.kobelco.co.jp/english/welding/sds/>
- Please be informed that special warning indication may be required in certain area. You are kindly requested to check local laws/regulations where welding materials are to be used.

# Lists of Welding Consumables

Welding Process	Product names	AWS	EN	ASME		Page
				F No.	A No.	
<b>For Mild Steel and 490MPa High Tensile Strength Steel</b>						
SMAW	<b>KOBE-6010</b>	A5.1 E6010	-	3	1	32
	<b>B-33</b>	A5.1 E6013	-	2	1	33
	<b>RB-26</b>	A5.1 E6013	ISO 2560-A-E 35 0 R	2	1	34
	<b>Z-44</b>	A5.1 E6013	-	2	1	35
	<b>B-10</b>	A5.1 E6019	-	2	1	36
	<b>B-14</b>	A5.1 E6019	ISO 2560-A-E 35 2 RA	2	1	37
	<b>B-17</b>	A5.1 E6019	-	2	1	38
	<b>LB-26</b>	A5.1 E7016	-	4	1	39
	<b>LB-52</b>	A5.1 E7016	ISO 2560-A-E 42 3 B	4	1	40
	<b>LB-52A</b>	A5.1 E7016	-	4	1	41
	<b>LB-52U</b>	A5.1 E7016	ISO 2560-A-E 42 2 B	4	1	42
	<b>LB-57</b>	A5.1 E7016	-	4	1	44
	<b>LB-52-18</b>	A5.1 E7018	ISO 2560-A-E 42 3 B	4	1	45
	<b>LT-B52A</b>	A5.1 E7018	-	4	1	46
	<b>LB-52T</b>	A5.1 E7048	-	4	1	47
	<b>LB-78VS</b>	A5.1 E7048	-	4	1	48
	<b>KOBE-7010S</b>	A5.5 E7010-P1	-	3	-	49
	<b>KOBE-8010S</b>	A5.5 E8010-P1	-	3	-	50
	<b>LB-55U</b>	A5.5 E8016-G	-	4	-	43
	<b>LB-8018</b>	A5.5 E8018-G	-	4	-	51
	<b>LB-88VS</b>	A5.5 E8018-G	-	4	-	53
	<b>LB-98VS</b>	A5.5 E9018-G	-	4	-	54
	<b>LB-76</b>	-	-	4	1	52
<b>LT-B50</b>	-	-	-	1	55	
FCAW	<b>MX-100T</b>	A5.18 E70C-6C/6M	ISO 17632-A-T 42 2 M C/M 1 H5	6	-	56
	<b>MX-A100</b>	A5.18 E70C-6M	ISO 17632-A-T 42 4 M M 3 H5	6	-	57
	<b>DW-200</b>	A5.20 E70T-1C	-	6	-	58
	<b>MX-100</b>	A5.20 E70T-1C	-	6	-	59

Note: Classification stated herein are in accordance with basically the mechanical and chemical requirements of the standard. Please ask KOBELCO for details.

Welding Process	Product names	AWS	EN	ASME		Page
				F No.	A No.	
FCAW	<b>MX-200</b>	A5.20 E70T-1C	ISO 17632-A-T 42 0 R C 3 H5	6	-	60
	<b>MX-200H</b>	A5.20 E70T-1C	ISO 17632-A-T 42 2 R C 3 H5	6	-	61
	<b>MX-200E</b>	A5.20 E70T-9C	-	6	-	62
	<b>MX-A200</b>	A5.20 E70T-1M	ISO 17632-A-T 42 2 R M 3 H5	6	-	63
	<b>DW-50</b>	A5.20 E71T-1C/1M, -9C/9M	ISO 17632-A-T 42 2 P C/M 1 H5	6	1	64
	<b>DW-100</b>	A5.20 E71T-1C	ISO 17632-A-T 42 0 P C 1 H10	6	1	65
	<b>DW-100V</b>	A5.20 E71T-1C	-	6	1	66
	<b>DW-100E</b>	A5.20 E71T-9C	-	6	1	67
	<b>DW-A50</b>	A5.20 E71T-1M	ISO 17632-A-T 42 2 P M 1 H5	6	1	68
	<b>DW-A51B</b>	A5.20 E71T-5M-J	-	6	1	69
GMAW	<b>MIX-50</b>	A5.18 ER70S-3	-	6	-	70
	<b>MG-51T</b>	A5.18 ER70S-6	-	6	1	71
	<b>MG-50</b>	A5.18 ER70S-G	-	6	1	72
	<b>MG-S50</b>	A5.18 ER70S-G	-	6	1	73
	<b>MIX-50S</b>	A5.18 ER70S-G	-	6	1	74
	<b>SE-A50</b>	A5.18 ER70S-G	-	6	1	75
	<b>MG-50T</b>	-	-	-	1	76
	<b>MIX-1TS</b>	-	-	-	-	77
GTAW	<b>NO65G</b>	A5.18 ER70S-2	-	6	1	78
	<b>TG-S70S2</b>	A5.18 ER70S-2	-	6	1	79
	<b>TG-S70S3</b>	A5.18 ER70S-3	-	6	1	80
	<b>TG-S51T</b>	A5.18 ER70S-6	-	6	1	81
	<b>TG-S50</b>	A5.18 ER70S-G	-	6	1	82
SAW	<b>MF-53/US-36</b>	A5.17 F7A0-EH14	-	6	-	83
	<b>G-50/US-36</b>	A5.17 F7A2-EH14	-	6	-	84
	<b>G-60/US-36</b>	A5.17 F7A2-EH14	-	6	-	85
	<b>G-80/US-36</b>	A5.17 F7A2-EH14, F6P2-EH14	-	6	-	86

Note: Classification stated herein are in accordance with basically the mechanical and chemical requirements of the standard. Please ask KOBELCO for details.

Welding Process	Product names	AWS	EN	ASME		Page
				F No.	A No.	
SAW	<b>AF-490E/US-29</b>	A5.17 F7A2-EM12K, F6P4-EM12K	-	6	1	90
	<b>PF-H55E/US-36</b>	A5.17 F7A4-EH14	-	6	1	87
	<b>AF-490SP/US-36</b>	A5.17 F7A4-EH14, F7P4-EH14	-	6	1	91
	<b>MF-38/US-36</b>	A5.17 F7A6-EH14, F7P6-EH14	-	6	-	88
	<b>MF-300/US-36</b>	A5.17 F7A6-EH14, F7P6-EH14	-	6	-	89
	<b>AF-490AS/US-36</b>	A5.17 F7A6-EH14, F7P6-EH14	-	6	-	92

### For Weather Proof Steel

SMAW	<b>LB-W52</b>	A5.5 E7016-G	-	4	-	96
	<b>LB-W52B</b>	A5.5 E7016-G	-	4	-	97
FCAW	<b>DW-588</b>	A5.29 E81T1-W2C	-	6	-	98
	<b>DW-50W</b>	-	-	-	-	99
GMAW	<b>MG-W50TB</b>	A5.28 ER80S-G	-	6	-	100
SAW	<b>MF-53/US-W52B</b>	A5.23 F7A0-EG-G	-	6	-	101
	<b>MF-38/US-W52B</b>	A5.23 F7A2-EG-G	-	6	-	102

### For High Tensile Strength Steel and Low Temperature Steel

SMAW	<b>LB-7018-1</b>	A5.1 E7018-1	ISO 2560-A-E 42 4 B	4	1	110
	<b>NB-3J</b>	A5.5 E7016-C2L	-	4	10	111
	<b>LB-52NS</b>	A5.5 E7016-G	-	4	-	114
	<b>LB-52NSU</b>	A5.5 E7016-G	-	4	-	115
	<b>LB-62L</b>	A5.5 E8016-C1	ISO 2560-A-E 50 6 2Ni B	4	10	112
	<b>LB-65L</b>	A5.5 E8016-C1	-	4	10	113
	<b>LB-55NS</b>	A5.5 E8016-G	-	4	-	116
	<b>NB-1SJ</b>	A5.5 E8016-G	-	4	10	117
	<b>LB-62</b>	A5.5 E9016-G	ISO 2560-A-E 50 3 Z B 1 2	4	-	118
	<b>LB-62UL</b>	A5.5 E9016-G	-	4	-	119
	<b>LB-62U</b>	A5.5 E9016-G	-	4	-	120
	<b>LB-67L</b>	A5.5 E9016-G	-	4	10	121
	<b>LB-62D</b>	A5.5 E9018-G	-	4	-	122
	<b>LB-106</b>	A5.5 E10016-G	-	4	-	123
	<b>LB-Y75</b>	A5.5 E10016-G	-	4	-	124
	<b>LB-70L</b>	A5.5 E10016-G	-	4	-	125

Note: Classification stated herein are in accordance with basically the mechanical and chemical requirements of the standard. Please ask KOBELCO for details.

Welding Process	Product names	AWS	EN	ASME		Page
				F No.	A No.	
SMAW	<b>LB-116</b>	A5.5 E11016-G	ISO 18275-A- E 69 2 ZMn2NiCrMo B	4	12	126
	<b>LB-80UL</b>	A5.5 E11016-G	-	4	12	127
	<b>LB-88LT</b>	A5.5 E11016-G	-	4	-	128
	<b>LB-80L</b>	A5.5 E11018-G H4	18275-A E69 6 ZMn3Ni2Mo B 2 2 H5	4	-	129
FCAW	<b>MX-55LF</b>	A5.20 E70T-9C-J	-	6	-	136
	<b>DW-100KS</b>	A5.20 E71T-1C, E71T-9C-J	-	6	-	130
	<b>DW-55E</b>	A5.20 E71T-9C-J	ISO 17632-A- T 42 4 P C 1 H5	6	-	131
	<b>DW-A55E</b>	A5.20 E71T-9M-J	ISO 17632-A- T 42 4 P M 1 H5	6	1	132
	<b>DW-A55ESR</b>	A5.20 E71T-12M-J	ISO 17632-A- T 42 4 P M 1 H5	6	1	133
	<b>MX-A55T</b>	A5.28 E80C-G	ISO 17632-A- T 46 6 1.5Ni M M 1 H5	6	10	144
	<b>MX-A55Ni1</b>	A5.28 E80C-G	ISO 17632-A- T 46 6 Mn1Ni M M 3 H5	6	-	145
	<b>MX-A80L</b>	A5.28 E110C-G H4	ISO 18276-A- T69 6 Mn2.5Ni M M 3 H5	6	-	146
	<b>DW-50LSR</b>	A5.29 E71T1-GC	-	6	-	147
	<b>DW-55L</b>	A5.29 E81T1-K2C	ISO 17632-A- T 46 6 1.5Ni P C 1 H5	6	10	134
	<b>DW-55LSR</b>	A5.29 E81T1-K2C	ISO 17632-A- T 46 6 1.5Ni P C 1 H5	6	10	135
	<b>DW-A55L</b>	A5.29 E81T1-K2M	ISO 17632-A- T 46 6 1.5Ni P M 1 H5	6	10	137
	<b>DW-A55LSR</b>	A5.29 E81T1-Ni1M	ISO 17632-A- T 46 6 Z P M 1 H5	6	10	138
	<b>DW-A81Ni1</b>	A5.29 E81T1-Ni1M-J	ISO 17632-A- T 46 6 1Ni P M 2 H5	6	10	139
	<b>DW-A65Ni1</b>	A5.29 E91T-GM	ISO 18276-A- T 55 5 Mn1Ni P M 2 H5	6	10	140
	<b>DW-62L</b>	A5.29 E91T1-Ni2C-J	ISO 17632-A- T 50 6 Z P C 2 H5	6	10	141
	<b>DW-A62L</b>	A5.29 E91T1-Ni2M-J	ISO 17632-A- T 50 6 Z P M 2 H5	6	10	142
	<b>DW-A62LSR</b>	A5.29 E91T1-GM	-	6	10	143
	<b>DW-A70L</b>	A5.29 E101T1-GM	ISO 18276-A- T62 5 Mn1NiMo P M 2 H5	6	-	148

Note: Classification stated herein are in accordance with basically the mechanical and chemical requirements of the standard. Please ask KOBELCO for details.

Welding Process	Product names	AWS	EN	ASME		Page
				F No.	A No.	
FCAW	DW-A80L	A5.29 E111T1-GM-H4	ISO 18276-A-T69 4 Z P M 2 H5	6	-	149
	DW-460L	-	-	-	-	150
GMAW	MG-S50LT	A5.18 ER70S-G	-	6	-	151
	MG-S1N	A5.28 ER70S-G	-	6	10	152
	MG-S3N	A5.28 ER70S-G	-	6	-	153
	MG-60	-	-	6	-	154
	MG-S63B	A5.28 ER90S-G	-	6	-	155
	MG-70	A5.28 ER100S-G	-	6	-	156
	MG-S70	A5.28 ER100S-G	-	6	12	157
	MG-80	A5.28 ER110S-G	-	6	-	158
	MG-S80	A5.28 ER110S-G	-	6	-	159
	MG-S88A	A5.28 ER120S-G	-	6	-	160
GTAW	TG-S1N	A5.28 ER70S-G	-	6	-	161
	TG-S3N	A5.28 ER70S-G	-	6	10	162
	TG-S62	A5.28 ER80S-G	-	6	2	163
	TG-S60A	A5.28 ER80S-G	-	6	-	164
	TG-S80AM	A5.28 ER110S-G	-	6	-	165
SAW	MF-38/US-49A	A5.17 F7A6-EH14, F7P6-EH14	-	6	-	166
	PF-H55LT/US-36	A5.17 F7A8-EH14, F7P8-EH14	-	6	-	167
	PF-H55AS/US-36J	A5.17 F7A8-EH14, F7P8-EH14	-	6	1	168
	PF-H203/US-203E	A5.23 F7P15-ENi3-Ni3	-	6	10	169
	MF-38/US-A4	A5.23 F8A4-EA4-A4, F8P6-EA4-A4	-	6	2	170
	MF-38/US-49	A5.23 F8A4-EG-A4, F8P6-EG-A4	-	6	2	172
	MF-38/US-40	A5.23 F9A6-EA3-A3, F8P6-EA3-A3	-	6	-	171
	PF-H62AS/US-2N	A5.23 F9A8-EG-Ni2, F9P8-EG-Ni2	-	6	10	174
	PF-H62AK/US-2N	A5.23 F9A8-EG-Ni2, F9P8-EG-Ni2	-	6	10	175

Note: Classification stated herein are in accordance with basically the mechanical and chemical requirements of the standard. Please ask KOBELCO for details.



Welding Process	Product names	AWS	EN	ASME		Page
				F No.	A No.	
SAW	PF-H55S/US-2N	A5.23 F9A10-EG-Ni2, F9P8-EG-Ni2	-	6	-	173
	PF-H80AS/US-80LT	A5.23 F11A10-EG-G	-	6	-	176
	PF-H80AK/US-80LT	A5.23 F12A10-EG-G	-	6	-	177
<b>For Heat-Resistant Steel</b>						
SMAW	CM-B95	A5.5 E7015-B2L	-	4	3	192
	CM-A76	A5.5 E7016-A1	-	4	2	188
	CM-B105	A5.5 E8015-B3L	-	4	4	197
	CM-A96	A5.5 E8016-B2	ISO 3580-A-E CrMo1 B	4	3	189
	CM-A96MB	A5.5 E8016-B2	-	4	3	190
	CM-A96MBD	A5.5 E8016-B2	-	4	3	191
	CM-B98	A5.5 E8018-B2	-	4	3	193
	CM-95B91	A5.5 E9015-B91	-	4	5	202
	CM-A106	A5.5 E9016-B3	ISO 3580-A-E CrMo2 B	4	4	194
	CM-A106N	A5.5 E9016-B3	-	4	4	195
	CM-A106ND	A5.5 E9016-B3	-	4	4	196
	CM-96B91	A5.5 E9016-B91	-	4	5	203
	BL-96	A5.5 E9016-G	ISO 3580-A-E Z B	4	-	186
	CM-A106H	A5.5 E9016-G	-	-	4	199
	CM-A106HD	A5.5 E9016-G	-	-	4	200
	CM-2CW	A5.5 E9016-G	-	4	-	201
	CM-9Cb	A5.5 E9016-G	-	4	-	204
	CR-12S	A5.5 E9016-G	-	4	-	205
	CM-B108	A5.5 E9018-B3	-	4	4	198
	BL-106	A5.5 E10016-G	ISO 18275-A- E 62 0 ZMn1NiMo B T	4	-	187
GMAW	MG-S70SA1	A5.28 ER70S-A1	-	6	2	208
	MG-S80B2F	A5.28 ER80S-B2	-	6	3	211
	MG-S1CM	A5.28 ER80S-B2Mn	-	6	3	210
	MG-S56	A5.28 ER80S-G	-	6	-	206
	MG-SM	A5.28 ER80S-G	-	6	2	209
	MG-S2CM	A5.28 ER90S-B3MnSi	-	6	4	212

Note: Classification stated herein are in accordance with basically the mechanical and chemical requirements of the standard. Please ask KOBELCO for details.

Welding Process	Product names	AWS	EN	ASME		Page
				F No.	A No.	
GMAW	<b>MG-S90B91</b>	A5.28 ER90S-B91	-	6	5	214
	<b>MG-S9Cb</b>	A5.28 ER90S-B91CMn	-	6	-	215
	<b>MG-S63S</b>	A5.28 ER90S-G	-	6	-	207
	<b>MG-S2CW</b>	A5.28 ER90S-G	-	6	-	213
	<b>MG-S12CRS</b>	A5.28 ER90S-G	-	6	-	216
GTAW	<b>TG-S70SA1</b>	A5.28 ER70S-A1	-	6	2	219
	<b>TG-S80B2</b>	A5.28 ER80S-B2	-	6	3	221
	<b>TG-S1CM</b>	A5.28 ER80S-B2Mn	-	6	3	222
	<b>TG-S56</b>	A5.28 ER80S-G	-	6	11	217
	<b>TG-SM</b>	A5.28 ER80S-G	-	6	2	220
	<b>TG-S1CML</b>	A5.28 ER80S-G	-	6	3	223
	<b>TG-S2CML</b>	A5.28 ER80S-G	-	6	4	226
	<b>TG-S2CW</b>	A5.28 ER80S-G	-	6	-	228
	<b>TG-S90B3</b>	A5.28 ER90S-B3	-	6	4	224
	<b>TG-S2CM</b>	A5.28 ER90S-B3Mn	-	6	4	225
	<b>TG-S90B91</b>	A5.28 ER90S-B91	-	6	5	229
	<b>TG-S9Cb</b>	A5.28 ER90S-B91C	-	6	5	230
	<b>TG-S63S</b>	A5.28 ER90S-G	-	6	12	218
	<b>TG-S2CMH</b>	A5.28 ER90S-G	-	-	4	227
<b>TG-S12CRS</b>	A5.28 ER90S-G	-	6	-	231	
SAW	<b>G-80/US-B2</b>	A5.23 F7PZ-EB2-B2	-	6	3	239
	<b>MF-38/US-A4</b>	A5.23 F8P6-EA4-A4, F8A4-EA4-A4	-	6	2	234
	<b>MF-38/US-49</b>	A5.23 F8P6-EG-A4, F8A4-EG-A4	-	6	2	235
	<b>MF-38/US-40</b>	A5.23 F8P6-EA3-A3, F9A6-EA3-A3	-	6	-	236
	<b>PF-200/US-511N</b>	A5.23 F8P2-EG-B2	-	6	3	237
	<b>PF-200D/US-511ND</b>	A5.23 F8P2-EG-B2	-	6	3	238
	<b>PF-200D/US-B2R</b>	A5.23 F8P2-EB2R-B2R	-	6	3	240
	<b>PF-200/US-521S</b>	A5.23 F9P2-EG-B3	-	6	4	241
	<b>PF-200D/US-521S</b>	A5.23 F9P2-EG-B3	-	6	4	242
	<b>PF-500/US-521H</b>	A5.23 F9P2-EG-G	-	-	4	243

Note: Classification stated herein are in accordance with basically the mechanical and chemical requirements of the standard. Please ask KOBELCO for details.

Welding Process	Product names	AWS	EN	ASME		Page
				F No.	A No.	
SAW	<b>PF-200/US-56B</b>	A5.23 F9P4-EG-G	-	6	-	232
	<b>PF-200S/US-90B91</b>	A5.23 F9PZ-EB91-B91	-	6	5	245
	<b>PF-90B91/US-90B91</b>	A5.23 F9PZ-EB91-B91	-	6	-	246
	<b>PF-200/US-63S</b>	A5.23 F10P2-EG-G	-	6	-	233
	<b>PF-200S/US-9Cb</b>	A5.23 F10PZ-EG-G	-	6	-	247
	<b>MF-29A/US-2CW</b>	-	-	-	-	244
	<b>PF-200S/US-12CRSD</b>	-	-	-	-	248
<b>For Stainless Steel</b>						
SMAW	<b>NC-38</b>	A5.4 E308-16	-	5	8	258
	<b>NC-38H</b>	A5.4 E308H-16	-	5	8	259
	<b>NC-38L</b>	A5.4 E308L-16	-	5	8	260
	<b>NC-38LT</b>	A5.4 E308L-16	-	5	8	261
	<b>NC-39</b>	A5.4 E309-16	-	5	8	262
	<b>NC-39L</b>	A5.4 E309L-16	ISO 3581-A-E 23 12 L R	5	8	263
	<b>NC-39MoL</b>	A5.4 E309LMo-16	-	5	8	264
	<b>NC-32</b>	A5.4 E312-16	-	5	-	265
	<b>NC-36</b>	A5.4 E316-16	-	5	8	266
	<b>NC-36L</b>	A5.4 E316L-16	-	5	8	267
	<b>NC-36LT</b>	A5.4 E316L-16	-	5	8	268
	<b>NC-317L</b>	A5.4 E317L-16	-	5	8	269
	<b>NC-37</b>	A5.4 E347-16	-	5	8	270
	<b>NC-37L</b>	A5.4 E347-16	ISO 3581-A-E Z 19 9 Nb R	5	8	271
	<b>CR-40Cb</b>	A5.4 E409Nb-16	-	4	7	272
	<b>CR-40</b>	A5.4 E410-16	-	4	6	273
	<b>NC-2209</b>	A5.4 E2209-16	-	5	8	274
<b>NC-2594</b>	A5.4 E2594-16	-	5	-	275	
<b>NC-316MF</b>	-	-	-	-	276	
FCAW	<b>DW-308H</b>	A5.22 E308HT1-1/4	-	6	8	277
	<b>DW-308L</b>	A5.22 E308LT0-1/4	ISO 17633-A-T 19 9 L R C1/M21 3	6	8	278
	<b>DW-308LT</b>	A5.22 E308LT0-1/4	-	6	8	279
	<b>DW-308L-XR</b>	A5.22 E308LT0-1/4	-	6	8	283

Note: Classification stated herein are in accordance with basically the mechanical and chemical requirements of the standard. Please ask KOBELCO for details.

Welding Process	Product names	AWS	EN	ASME		Page
				F No.	A No.	
FCAW	DW-308LH	A5.22 E308LT1-1/4	-	6	8	280
	DW-308LP	A5.22 E308LT1-1/4	ISO 17633-A-T 19 9 L P C1/M21 1	6	8	281
	DW-308LP-XR	A5.22 E308LT1-1/4	-	6	8	284
	DW-308	A5.22 E308T0-1/4	ISO 17633-A-T Z 19 9 R C1/M21 3	6	8	282
	DW-309MoL	A5.22 E309LMoT0-1/4	ISO 17633-A-T 23 12 2 L R C1/M21 3	6	8	285
	DW-309MoLP	A5.22 E309LMoT1-1/4	ISO 17633-A-T 23 12 2 L R C1/M21 1	6	8	286
	DW-309L	A5.22 E309LT0-1/4	ISO 17633-A-T 23 12 L R C1/M21 3	6	8	287
	DW-309L-XR	A5.22 E309LT0-1/4	-	6	8	291
	DW-309LH	A5.22 E309LT1-1/4	-	6	8	288
	DW-309LP	A5.22 E309LT1-1/4	ISO 17633-A-T 23 12 L P C1/M21 1	6	8	289
	DW-309LP-XR	A5.22 E309LT1-1/4	-	6	8	292
	DW-309	A5.22 E309T0-1/4	ISO 17633-A-T Z 23 12 R C1/M21 3	6	8	290
	DW-310	A5.22 E310T0-1/4	-	6	9	293
	DW-312	A5.22 E312T0-1	-	6	-	294
	DW-316L	A5.22 E316LT0-1/4	ISO 17633-A-T Z 19 12 3 R C1/M21 3	6	8	295
	DW-316L-XR	A5.22 E316LT0-1/4	-	6	8	300
	DW-316LT	A5.22 E316LT1-1/4	-	6	8	296
	DW-316LH	A5.22 E316LT1-1/4	-	6	8	297
	DW-316LP	A5.22 E316LT1-1/4	ISO 17633-A-T 19 12 3 L P C1/M21 1	6	8	298
	DW-316LP-XR	A5.22 E316LT1-1/4	-	6	8	301
	DW-316H	A5.22 E316T1-1/4	-	6	8	299
	DW-317L	A5.22 E317LT0-1/4	-	6	8	302
	DW-317LP	A5.22 E317LT1-1/4	-	6	8	303
	DW-347	A5.22 E347T0-1/4	-	6	8	304
	DW-410Cb	A5.22 E409NbT0-1	-	6	7	309
	DW-2209	A5.22 E2209T1-1/4	-	6	8	305

Note: Classification stated herein are in accordance with basically the mechanical and chemical requirements of the standard. Please ask KOBELCO for details.

Welding Process	Product names	AWS	EN	ASME		Page
				F No.	A No.	
FCAW	<b>DW-329AP</b>	A5.22 E2209T1-1/4	-	6	8	306
	<b>DW-2307</b>	A5.22 E2307T1-1/4	-	6	-	307
	<b>DW-2594</b>	A5.22 E2594T1-1/4	-	6	-	308
	<b>MX-A410NiMo</b>	A5.22 EC410NiMo	-	-	-	310
	<b>MX-A430M</b>	-	-	-	7	311
	<b>TG-X308L</b>	A5.22 R308LT1-5	-	-	8	313
	<b>TG-X309L</b>	A5.22 R309LT1-5	-	-	8	314
	<b>TG-X316L</b>	A5.22 R316LT1-5	-	-	8	315
	<b>TG-X347</b>	A5.22 R347T1-5	-	-	8	316
GMAW	<b>MG-S308</b>	A5.9 ER308	-	6	8	317
	<b>MG-S308LS</b>	A5.9 ER308LSi	-	6	8	318
	<b>MG-S309</b>	A5.9 ER309	-	6	8	319
	<b>MG-S309LS</b>	A5.9 ER309LSi	-	6	8	320
	<b>MG-S316LS</b>	A5.9 ER316LSi	-	6	8	321
GTAW	<b>TG-S308</b>	A5.9 ER308	-	6	8	322
	<b>TG-S308L</b>	A5.9 ER308L	-	6	8	323
	<b>TG-S309</b>	A5.9 ER309	-	6	8	324
	<b>TG-S309L</b>	A5.9 ER309L	-	6	8	325
	<b>TG-S309MoL</b>	A5.9 ER309LMo	-	6	8	326
	<b>TG-S310</b>	A5.9 ER310	-	6	9	327
	<b>TG-S316</b>	A5.9 ER316	-	6	8	328
	<b>TG-S316L</b>	A5.9 ER316L	-	6	8	329
	<b>TG-S317L</b>	A5.9 ER317L	-	6	8	330
	<b>TG-S347</b>	A5.9 ER347	-	6	8	331
	<b>TG-S410</b>	A5.9 ER410	-	6	6	332
	<b>TG-S2209</b>	A5.9 ER2209	-	6	8	333
	<b>TG-S2594</b>	A5.9 ER2594	-	6	-	334
	<b>TG-S310MF</b>	-	-	-	-	335
	<b>TG-S410Cb</b>	-	-	-	7	336
	<b>NO4051</b>	-	-	-	-	337
SAW	<b>PF-S1D/US-2209</b>	A5.9 ER2209*	-	6*	8	338

Note: Classification stated herein are in accordance with basically the mechanical and chemical requirements of the standard. Please ask KOBELCO for details.

※Wire only

Welding Process	Product names	AWS	EN	ASME		Page
				F No.	A No.	
<b>For Hardfacing</b>						
SMAW	HF-240	-	-	-	-	344
	HF-260	-	-	-	-	344
	HF-330	-	-	-	-	344
	HF-350	-	-	-	-	344
	HF-450	-	-	-	-	346
	HF-500	-	-	-	-	346
	HF-600	-	-	-	-	346
	HF-650	-	-	-	-	346
	HF-700	-	-	-	-	348
	HF-800K	-	-	-	-	348
	HF-950	-	-	-	-	348
	HF-11	-	-	-	-	350
	HF-12	-	-	-	-	350
	HF-13	-	-	-	-	350
	HF-16	-	-	-	-	350
HF-30	-	-	-	-	350	
FCAW	DW-H250	-	-	-	-	352
	DW-H350	-	-	-	-	352
	DW-H450	-	-	-	-	352
	DW-H600	-	-	-	-	352
	DW-H700	-	-	-	-	352
	DW-H800	-	-	-	-	352
	DW-H11	-	-	-	-	354
	DW-H16	-	-	-	-	354
<b>For Cast Iron</b>						
SMAW	CI-A1	A5.15 ENi-CI	-	-	-	360
	CI-A2	A5.15 ENiFe-CI	-	-	-	360
	CI-A3	-	-	-	-	360

Note: Classification stated herein are in accordance with basically the mechanical and chemical requirements of the standard. Please ask KOBELCO for details.

Welding Process	Product names	AWS	EN	ASME		Page
				F No.	A No.	
<b>For 9%Ni Steel and Nickel-Based Alloy</b>						
SMAW	<b>NI-C70A</b>	A5.11 ENiCrFe-1	-	43	-	368
	<b>NI-C703D</b>	A5.11 ENiCrFe-3	-	43	-	369
	<b>NI-C70S</b>	A5.11 ENiCrFe-9	-	43	-	370
	<b>NI-C1S</b>	A5.11 ENiMo-8	-	44	-	371
FCAW	<b>DW-N82</b>	A5.34 ENiCr3T1-4	-	43	-	372
	<b>DW-N625</b>	A5.34 ENiCrMo3T1-1/4	-	43	-	373
	<b>DW-NC276</b>	A5.34 ENiCrMo4T1-4	-	43	-	374
	<b>DW-N709SP</b>	A5.34 ENiMo13T1-1/4	ISO 12153-T Ni 1013 P M21 2	43	-	375
GMAW	<b>MG-S70NCb</b>	A5.14 ERNiCr-3	-	43	-	376
GTAW	<b>TG-S70NCb</b>	A5.14 ERNiCr-3	-	43	-	377
	<b>TG-SN625</b>	A5.14 ERNiCrMo-3	-	43	-	378
	<b>TG-S709S</b>	A5.14 ERNiMo-8	-	44	-	379
SAW	<b>PF-N4/US-709S</b>	A5.14 ERNiMo-8※	-	44※	-	380
<b>Highly Efficient Welding Processes</b>						
FCB™	<b>PF-I55E/US-36/ PF-I50R</b>	-	-	-	-	382
FA-B	<b>MF-38/US-36/ RR-2/FA-B1</b>	-	-	-	-	384
	<b>MF-38/US-49/ RR-2/FA-B1</b>	-	-	-	-	384
	<b>PF-I52E/US-36/ RR-2/FA-B1</b>	-	-	-	-	384
EGW	<b>DW-S43G</b>	A5.26 EG70T-2	-	6	-	386
	<b>DW-S1LG</b>	-	-	-	-	386
	<b>DW-S60G</b>	-	-	-	-	386

Note: Classification stated herein are in accordance with basically the mechanical and chemical requirements of the standard. Please ask KOBELCO for details.

※Wire only





# **For Mild Steel and 490MPa High Tensile Strength Steel**

## **Welding Consumables for**

**SMAW**

**FCAW**

**GMAW**

**GTAW**

**SAW**

# SMAW

## A guide for selecting the type of stick electrode <sup>(1)</sup>

Type of covering and AWS classification	High titania potassium	Low hydrogen potassium	Iron oxide titania potassium	High cellulose sodium	Iron-powder titania
	E6013	E7016	E6019	E6010	E7024
<b>Weldability</b>					
▪ Crack resistant	○	◎	○	○	△
▪ X-ray soundness	○	◎	○	△	△
<b>Usability</b>					
▪ Penetration	○	○	◎	◎	△
▪ Spatter	○	○	○	△	○
▪ Suitability for thin metal	◎	△	○	△	○

Note (1) ◎: Excellent, ○: Good, △: Fair

### **Tips for better welding results**

---

- (1) Slag and fumes on tack weld beads absorb moisture; therefore, they must be removed right after tack welding to prevent adverse effects on the subsequent main welding.
- (2) When wind velocity is more than 3m/sec in field welding, use a wind screen, or nitrogen in the wind decreases X-ray soundness and impact value of the weld.
- (3) In welding medium and heavy thick mild steels by using non-low-hydrogen electrodes, keep the work at appropriate preheat and interpass temperature to remove diffusible hydrogen and thereby prevent cracking in the weld.
- (4) In order to get better impact values, it is effective to lay each weld layer as thin as possible.
- (5) Many stick electrodes can be used with both AC and DC power sources. Low-hydrogen type electrodes, however, should be tested on mechanical properties beforehand, because DC current causes a little lower strength of the weld metal.
- (6) Low-hydrogen type electrodes are more suitable for surface finishing and repair welding of gas shielded metal arc and self-shielded metal arc welded deposits in order to prevent pits and blowholes, than other type electrodes.

### **How to keep stick electrodes in good condition**

---

- (1) Store stick electrodes in a warehouse where the humidity is low.
- (2) Low-hydrogen type electrodes should be stored in an oven (100-150°C) placed near the welding area after re-drying was finished so that welders can take out the electrodes little by little. This manner is good for preventing the electrodes from moisture pick up and thereby decrease the diffusible hydrogen content of the weld metal.
- (3) A change of the color of the flux coating to become darker, much more spatter, stronger arc, and irregular slag-covering are signs that the electrodes picked up moisture excessively. In such a case, re-drying is effective even for non-low-hydrogen electrodes to improve usability and X-ray soundness. But excessive drying for long hours at high temperatures deteriorates X-ray soundness of the weld metal.
- (4) Welders should bring an appropriate amount of electrodes for half-a-day use at sites in order to prevent electrodes from excessive moisture pick up.

## A guide for selecting filler metals for API grade pipes <sup>(1)</sup>

API 5L pipe grade	Welding pass	High cellulose electrodes	Low hydrogen electrodes		
		Downhill welding process	Downhill welding	Uphill welding	Downhill welding
			With a combination of electrodes	Low hydrogen electrodes	
<b>A25 A, B X42 X46 X52</b>	Root	KOBE-6010 KOBE-7010S	KOBE-6010 KOBE-7010S	LB-52U	LB-78VS
	Hot			LB-52 LB-52-18	
	Filler and cap		LB-78VS		
<b>X56</b>	Root	KOBE-6010 KOBE-7010S	KOBE-6010 KOBE-7010S	LB-52U	LB-78VS
	Hot			LB-52 LB-52-18	
	Filler and cap		LB-78VS		
<b>X60</b>	Root	KOBE-6010 KOBE-7010S	KOBE-6010 KOBE-7010S	LB-52U	LB-78VS LB-88VS
	Hot			LB-52 LB-52-18	
	Filler and cap		LB-78VS LB-88VS		
<b>X65</b>	Root	KOBE-7010S KOBE-8010S	KOBE-7010S KOBE-8010S	LB-52U	LB-88VS
	Hot			LB-57 LB-62 LB-62D LB-8018	
	Filler and cap		LB-88VS		
<b>X70</b>	Root	KOBE-7010S KOBE-8010S	KOBE-7010S KOBE-8010S	LB-55U LB-62U	LB-88VS
	Hot			LB-62 LB-62D	
	Filler and cap		LB-88VS		
<b>X80</b>	Root	-	KOBE-7010S KOBE-8010S	LB-62U	LB-98VS
	Hot			LB-65D	
	Filler and cap		LB-98VS		
<b>Weldability</b>					
▪ Stability of root pass		○	○	◎	△
▪ Weld soundness		○	○	◎	○
▪ Crack resistance		△	○	◎	◎
<b>Welding efficiency</b>		◎	◎	△	○
<b>Groove size tolerance</b>		○	○	◎	△

Note (1) ◎: Excellent, ○: Fair, △: Inferior

## Tips for better welding results

### 1) Sizes and tolerances of welding grooves

In one-side butt welding of pipes, it is important to make sound root pass welds without incomplete joint penetration and other discontinuities. For this, it is essential to prepare welding grooves suitable for individual welding procedures. Refer to the recommended sizes and tolerances of the grooves shown in the table below.

Type of stick electrode	Welding process	Recommendation and tolerance	Groove angle degree	Root face mm	Root gap mm	Mis-alignment mm
High cellulose	Downhill	Recommendation	60-70	1.2-2.4 (1.2-2.0)	1.2-2.0	$\leq 0.8$
		Tolerance	50-75	0.8-2.4	0.8-2.4	$\leq 1.6$
Low hydrogen	Uphill	Recommendation	60-80 (70-80)	0.4-2.0	2.0-3.2 (2.0-2.6)	$\leq 1.6$ ( $\leq 0.8$ )
		Tolerance	55-90	0.4-2.4	1.6-3.6	$\leq 2.0$
	Downhill	Recommendation	60-80	1.2-2.0	2.6-3.4 (2.6-3.2)	$\leq 0.6$
		Tolerance	55-90	1.0-2.0	2.5-3.5	$\leq 1.0$

Note: Recommended ranges in parentheses are suitable for small diameter tubes with an approximate thickness of 7mm or less.

### 2) How to proceed root pass welding

- (1) Downhill welding should be started at the 11 to 1 o'clock position of a pipe, whereas uphill welding should be started at the 5 to 7 o'clock position in common procedures. However, welding should be started at where there is a narrower root opening.
- (2) It is recommended to strike an arc on the groove face and transfer the arc to the root of the groove, maintaining the arc in stable condition.
- (3) Joint penetration can be adjusted by controlling the shape of a keyhole molten crater by adjusting welding current, electrode holding angle, the extent of sticking an electrode into the root opening, and weaving width. Control the penetration more strictly particularly at the 12 o'clock position where reverse side bead extrusion tends to be excessive and the 6 o'clock position that tends to cause a concave reverse side beads.
- (4) Before joining beads particularly with low hydrogen electrodes, the end of the preceding bead should be tapered by grinding.
- (5) After the completion of root pass welding, remove slag and unacceptable portion of beads, and shape the beads along the entire circumference of the pipe by grinding. Particularly, where the weld surfaces contain deep undercut, the shaping should be conducted more carefully.

## Types and features of flux-cored wires

There are two types of flux cored wires: DW series rutile type and MX series metal type. Both DW and MX series include a variety of wires that use either CO<sub>2</sub> or Ar-CO<sub>2</sub> admixture shielding gas. The following paragraphs describe essential characteristics of both types of flux-cored wires to provide users with a useful guide.

### DW series:

DW series is the most popular type of flux-cored wire, most of which contains rutile flux. This series offers excellent weldability with good arc stability and very low spatter generation. With CO<sub>2</sub> or Ar-CO<sub>2</sub> admixture shielding gas, DW wires show good slag removability and smooth, glossy bead appearance. Because of high deposition rates, highly efficient welding can be conducted. DW series includes those suitable for out-of-position welding and those suitable for horizontal fillet welding for a variety of applications.

### MX series:

MX series is the flux-cored wire containing metal powder in flux. Due to high deposition rates, highly efficient welding can be conducted. MX wires offer excellent weldability with good arc stability and low spatter generation. With some wires, the amount of slag is as little as in gas metal arc welding with solid wires; therefore, multi-pass welding can continuously be conducted without removing the slag on each pass. A variety of MX wires are available to cover wide applications of thin plate, medium and thick plate, and primer-coated plates.

### Deposition rate:

Compared at the same welding current, the deposition rates of flux-cored wires are higher by 50 - 60% relative to stick electrodes and 10 - 20% higher than solid wires. Spatter generation in use of flux-cored wires is much lower than in use of solid wires.

## Tips for better welding results

In addition to the tips for gas metal arc welding with solid wires, the following tips especially for flux-cored wires are essential to use the excellent features of the wires.

- (1) Because the wire is softer than solid wire, do not excessively tighten the pressure roller of the wire feeder so as not to cause the deformation of the wire.
- (2) In flat butt welding, backhand technique is better for stable penetration. In horizontal and overhead fillet welding, forehand technique is better for flat bead appearance.
- (3) In vertical down fillet welding, the first layer run should be straight and keep the welding speed faster to avoid slag inclusions and to get better penetration. For the 2nd and subsequent layers, remove the slag of preceding beads and avoid weaving.
- (4) In one-side welding, welding parameter should carefully be selected to prevent welding defects such as hot cracking.
- (5) In horizontal fillet welding of primer-coated plates, porosity defects such as pit and gas hole are apt to occur; therefore, the selection of proper wires and welding parameters suitable for welding primer-coated plates are essential. Figure 1 shows the relationship between welding speed and the number of leg pits occurred in the weld metal. Figure 2 shows proper welding speeds related to fillet leg lengths.

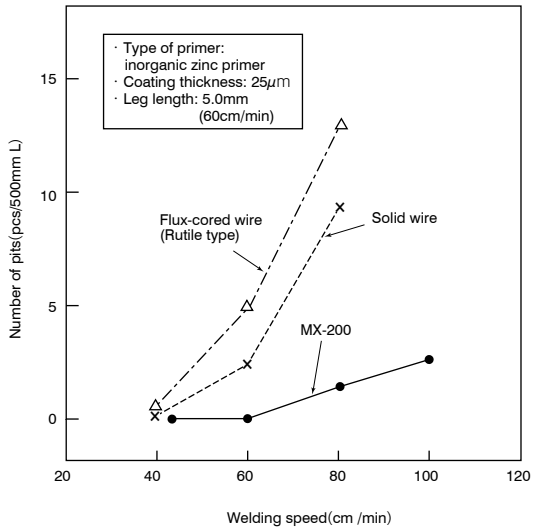

Fig.1 Porosity resistance to primer

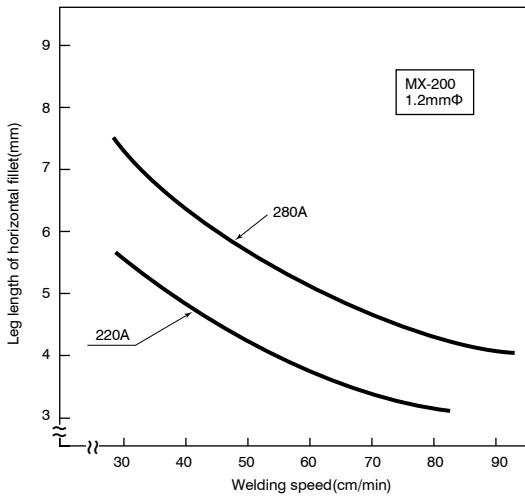

Fig.2 Horizontal fillet leg length vs. welding speed

# GMAW, GTAW

## Tips for better welding results in GMAW

- (1) Use a CO<sub>2</sub> shielding gas corresponding to ANSI/AWS A5.32/A5.32M SG-C or an equivalent CO<sub>2</sub> gas purified for welding.
- (2) Control the mixing ratio of Ar and CO<sub>2</sub> in an Ar-CO<sub>2</sub> admixture shielding gas because fluctuation of the mixing ratio affects the usability of a solid wire.
- (3) Adjust the shielding gas flow rate in the 20 to 25 l/min range.
- (4) Use a wind screen in welding in a windy area because a strong wind causes blowholes.
- (5) Use a proper ventilation system at where general ventilation is inadequate.
- (6) Keep the tip-to-work distance at around 15 mm with welding currents less than 250A and at around 20 to 25 mm with welding currents over 250A.
- (7) The use of an excessively low arc voltage may generate a large sound in spray arc welding with an Ar-CO<sub>2</sub> shielding gas. In such a case increase the arc voltage to prevent blowholes.
- (8) Torch angle, welding speed, wire diameter, and welding current markedly affect bead appearance and penetration; therefore, adjust such welding parameters according to the application.

## Tips for better welding results in GTAW

- (1) Welding power source:  
Use the DCEN connection with the constant current or drooping characteristic DC power source in general applications.
- (2) Shielding gas:  
Use an argon gas with a high purity equivalent to that of JIS K 1105, in order to prevent pits and blowholes in the weld metal and decrease consumption of the tip of a tungsten electrode. When the length of the Ar gas piping is long, use metal pipes or Teflon tubes to prevent porosity in the weld metal, because moisture can permeates into the Ar gas through the wall of a rubber hose and thereby causes porosity. Adjust the shielding gas flow rate in the 12-18 l/min range.
- (3) Tungsten electrode:  
A 1-2% thoriated tungsten electrode is suitable. The tip of the tungsten electrode must be kept sharp in order to maintain the arc stable.
- (4) Tungsten electrode extension length and arc length:  
In order to keep the shielding of molten weld pool in good condition, the extension of a tungsten electrode from shielding nozzle should be approx. 5 mm. Maintain the arc length at 1-3 mm. The use of an excessively long arc length can deteriorate the shielding effect and causes undercut.
- (5) Cleaning of welding groove:  
Because the quality of gas tungsten arc welds is markedly affected by dirt on groove surfaces, scale, rust, water and oil must be removed before welding because they can cause pits, blowholes and unstable arcs.
- (6) Wind protection and ventilation:  
Use a wind screen in a windy site to maintain the shielding gas in good condition. Use an appropriate ventilation system where welding is carried out in a confined area to prevent welders from oxygen deficiency.



## Tips for better welding results in SAW

(1) Accuracy of groove sizes:

The accuracy of root gap and groove angle affects the quality of welds much more than with other welding processes; where the accuracy is poor, burn-through, lack of penetration, excessive or insufficient reinforcement can occur.

(2) Surface of groove:

Rust and oil in the groove shall be removed before welding to prevent pits and blowholes.

(3) Distribution and circulation of flux:

Where a flux is supplied excessively on the base plate, the bead appearance becomes irregular particularly in use of melted fluxes. In case where a flux is used repetitively by means of a circulation system, the flux can be contaminated with scale and dust and its grain size distribution can be varied; therefore, add new flux occasionally to maintain good performances of the flux.

(4) Grain size of flux:

Several grain sizes are available for a certain melted flux. The most proper size depends on welding currents to be used. The use of high currents with a coarse grain size flux can deteriorates bead appearance; in contrast, the use of low currents with a fine grain size flux can cause pock marks because of poor degassing.

(5) Welding condition and penetration:

Submerged arc welding can use a wide range of parameters such as wire diameter, welding current, arc voltage and welding speed; however, erroneous setting of the parameter causes burn-through, and insufficient or excessive penetration and reinforcement. The bead shape can be affected by the travel angle of a wire; that is, where the wire is leaned to the direction of welding (backhand welding), the bead shape becomes narrower with comparatively deep penetration. In contrast, where the wire is leaned to the opposite direction of welding (forehand welding), the bead shape becomes wider with shallower penetration.

## Stick electrode

- Features:**
- Suitable for butt welding of pipes
  - Excellent usability in vertical downward welding

**Classification:** AWS A5.1 E6010

**Identification color:** 1st Yellowish green

**Polarity:** DCEP

### Welding Positions:

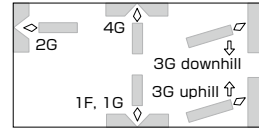

## Packaging data

$\phi$ mm	Length mm	kg/pack	kg/carton	g/piece	carton mm
2.4	300	2	20	13	300W, 100H, 330L
3.2	350	5	20	27	175W, 115H, 380L
4.0	350	5	20	40	175W, 115H, 380L
4.8	350	5	20	58	175W, 115H, 380L

## Composition (all-weld metal mass%)

	Typical	Guaranty <sup>a</sup>
<b>C</b>	0.12	0.20
<b>Si</b>	0.15	1.00
<b>Mn</b>	0.51	1.20
<b>P</b>	0.009	0.035
<b>S</b>	0.008	0.035
<b>Ni</b>	0.02	0.30
<b>Cr</b>	0.02	0.20
<b>Mo</b>	<0.01	0.30
<b>V</b>	<0.01	0.08

Note: <sup>a</sup> Single values are maximum.

## Welding parameters (A)

$\phi$ mm	1F, 1G, 2G, 3G uphill, 3G downhill, 4G
2.4	40~75
3.2	70~130
4.0	90~180
4.8	140~225

## All-weld mechanical properties

	Typical	Guaranty
<b>0.2%YS (MPa)</b>	430	331min.
<b>TS (MPa)</b>	510	414min.
<b>EI on 4d (%)</b>	27	22min.
<b>IV -29°C (J)</b>	63	27min.

**Stick electrode**

**Features:** • Excellent usability in the flat and horizontal positions

**Welding Positions:**

**Classification:** AWS A5.1 E6013

**Redrying Conditions:** 70~100°Cx0.5~1h

**Identification color:** 1st Pink

**Polarity:** AC, DCEP, DCEN

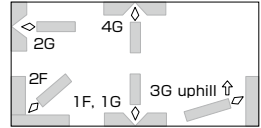
**Packaging data**

φ mm	Length mm	kg/pack	kg/carton	g/piece	carton mm
2.0	300	2	20	10	270W, 85H, 330L
2.6	350	5	20	20	170W, 105H, 380L
3.2	350	5	20	30	170W, 105H, 380L
4.0	400	5	20	55	170W, 95H, 430L
5.0	400	5	20	82	170W, 100H, 430L
6.0	450	5	20	138	170W, 90H, 480L

**Composition (all-weld metal mass%)**

	Typical (AC)	Guaranty <sup>a</sup>
<b>C</b>	0.08	0.20
<b>Si</b>	0.30	1.00
<b>Mn</b>	0.33	1.20
<b>P</b>	0.013	0.035
<b>S</b>	0.009	0.035
<b>Ni</b>	0.01	0.30
<b>Cr</b>	0.02	0.20
<b>Mo</b>	<0.01	0.30
<b>V</b>	0.01	0.08

**Welding parameters (A)**

φ mm	1F, 1G, 2F, 2G	3G uphill, 4G
2.0	30~60	30~60
2.6	55~95	50~90
3.2	80~130	70~120
4.0	125~175	100~160
5.0	170~230	120~200
6.0	230~300	-

Note: <sup>a</sup> Single values are maximum.

**All-weld mechanical properties**

	Typical (AC)	Guaranty
<b>0.2%YS (MPa)</b>	430	331min.
<b>TS (MPa)</b>	480	414min.
<b>El on 4d (%)</b>	25	17min.

## Stick electrode

- Features:**
- Suitable for butt and fillet welding of thin plates
  - Excellent usability in all positions including vertical downward

**Classification:** AWS A5.1 E6013

**Redrying Conditions:** 70~100°Cx0.5~1h

**Identification color:** 1st Black

**Polarity:** AC, DCEP, DCEN

## Welding Positions:

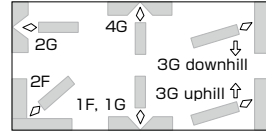

## Packaging data

φ mm	Length mm	kg/pack	kg/carton	g/piece	carton mm
2.0	300	2	20	10	270W, 90H, 330L
2.6	350	5	20	19	170W, 100H, 380L
3.2	350	5	20	29	170W, 100H, 380L
4.0	400	5	20	53	170W, 95H, 430L
5.0	400	5	20	81	170W, 95H, 430L

## Composition (all-weld metal mass%)

	Typical (AC)	Guaranty <sup>a</sup>
<b>C</b>	0.08	0.20
<b>Si</b>	0.30	1.00
<b>Mn</b>	0.37	1.20
<b>P</b>	0.012	0.035
<b>S</b>	0.010	0.035
<b>Ni</b>	0.01	0.30
<b>Cr</b>	0.02	0.20
<b>Mo</b>	<0.01	0.30
<b>V</b>	0.02	0.08

Note: <sup>a</sup>Single values are maximum.

## Welding parameters (A)

φ mm	1F, 1G, 2F, 2G, 3G downhill	3G uphill, 4G
2.0	30~65	30~65
2.6	45~95	45~95
3.2	60~125	60~125
4.0	105~170	100~150
5.0	150~220	125~190

## All-weld mechanical properties

	Typical (AC)	Guaranty
<b>0.2%YS (MPa)</b>	450	331min.
<b>TS (MPa)</b>	510	414min.
<b>EI on 4d (%)</b>	25	17min.

## Approvals

<b>ABS</b>	2
<b>LR</b>	2m
<b>NK<sup>a)</sup></b>	KMW2

Note: <sup>a)</sup> AC

## Stick electrode

**Features:** ▪ Typical lime titania type electrode

**Classification:** AWS A5.1 E6013

**Redrying Conditions:** 70~100°Cx0.5~1h

**Identification color:** 1st Silver grey, 2nd Blue white

**Polarity:** AC, DCEP, DCEN

## Welding Positions:

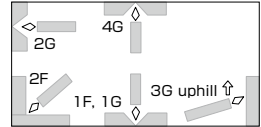

## Packaging data

φ mm	Length mm	kg/pack	kg/carton	g/piece	carton mm
2.0	300	2	20	11	270W, 85H, 330L
2.6	350	5	20	22	170W, 105H, 380L
3.2	350	5	20	34	170W, 105H, 380L
4.0	450	5	20	64	170W, 90H, 480L
5.0	450	5	20	98	170W, 90H, 480L
6.0	450	5	20	142	170W, 90H, 480L

## Composition (all-weld metal mass%)

	Typical (AC)	Guaranty <sup>a</sup>
<b>C</b>	0.08	0.20
<b>Si</b>	0.14	1.00
<b>Mn</b>	0.34	1.20
<b>P</b>	0.014	0.035
<b>S</b>	0.009	0.035
<b>Ni</b>	0.02	0.30
<b>Cr</b>	0.02	0.20
<b>Mo</b>	0.01	0.30
<b>V</b>	0.01	0.08

Note: <sup>a</sup> Single values are maximum.

## Welding parameters (A)

φ mm	1F, 1G, 2F, 2G	3G uphill, 4G
2.0	30~60	25~55
2.6	60~100	50~90
3.2	100~140	90~130
4.0	140~190	120~170
5.0	190~250	140~210
6.0	250~330	-

## All-weld mechanical properties

	Typical (AC)	Guaranty
<b>0.2%YS (MPa)</b>	410	331min.
<b>TS (MPa)</b>	460	414min.
<b>EI on 4d (%)</b>	32	17min.
<b>IV 0°C (J)</b>	110	-

## Approvals

<b>ABS</b>	3
<b>LR</b>	3m
<b>DNV</b>	3
<b>BV</b>	3
<b>NK</b>	KMW3

## Stick electrode

- Features:**
- Suitable for butt and fillet welding of thin and thick plates (up to 20mm)
  - Better usability

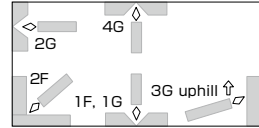
**Welding Positions:**

**Classification:** AWS A5.1 E6019

**Redrying Conditions:** 70~100°Cx0.5~1h

**Identification color:** 1st Green

**Polarity:** AC, DCEP, DCEN

## Packaging data

φ mm	Length mm	kg/pack	kg/carton	g/piece	carton mm
2.6	350	5	20	19	170W, 100H, 380L
3.2	350	5	20	30	170W, 105H, 380L
4.0	400	5	20	56	170W, 95H, 430L
5.0	400	5	20	84	170W, 95H, 430L
6.0	450	5	20	136	170W, 90H, 480L

## Composition (all-weld metal mass%)

	Typical (AC)	Guaranty <sup>a</sup>
<b>C</b>	0.10	0.20
<b>Si</b>	0.09	1.00
<b>Mn</b>	0.39	1.20
<b>P</b>	0.016	0.035
<b>S</b>	0.008	0.035
<b>Ni</b>	0.01	0.30
<b>Cr</b>	0.02	0.20
<b>Mo</b>	<0.01	0.30
<b>V</b>	<0.01	0.08

Note: <sup>a</sup> Single values are maximum.

## Welding parameters (A)

φ mm	1F, 1G, 2F, 2G	3G uphill, 4G
2.6	50~85	40~70
3.2	80~130	60~110
4.0	120~180	100~150
5.0	170~250	130~200
6.0	230~300	-

## All-weld mechanical properties

	Typical (AC)	Guaranty
<b>0.2%YS (MPa)</b>	400	331min.
<b>TS (MPa)</b>	450	414min.
<b>EI on 4d (%)</b>	30	22min.
<b>IV -18°C (J)</b>	68	27min.

## Stick electrode

- Features:**
- Suitable for butt and fillet welding of thin and medium-thick plates (up to 20mm)
  - Excellent usability

**Classification:** AWS A5.1 E6019

**Redrying conditions:** 70~100°Cx0.5~1h

**Identification color:** 1st Pale brown

**Polarity:** AC, DCEP, DCEN

## Welding Positions:

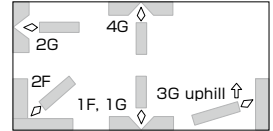

## Packaging data

φ mm	Length mm	kg/pack	kg/carton	g/piece	carton mm
2.6	350	5	20	20	170W, 120H, 380L
3.2	400	5	20	35	170W, 120H, 430L
4.0	450	5	20	62	170W, 120H, 480L
5.0	450	5	20	94	170W, 120H, 480L
6.0	450	5	20	141	170W, 120H, 480L

## Composition (all-weld metal mass%)

	Typical (AC)	Guaranty <sup>a</sup>
<b>C</b>	0.10	0.20
<b>Si</b>	0.10	1.00
<b>Mn</b>	0.43	1.20
<b>P</b>	0.015	0.035
<b>S</b>	0.007	0.035
<b>Ni</b>	0.01	0.30
<b>Cr</b>	0.02	0.20
<b>Mo</b>	<0.01	0.30
<b>V</b>	0.01	0.08

Note: <sup>a</sup> Single values are maximum.

## Welding parameters (A)

φ mm	1G, 1F, 2G, 2F	3G uphill, 4G
2.6	55~90	45~75
3.2	85~140	60~120
4.0	130~190	100~160
5.0	180~260	135~210
6.0	240~310	-

## All-weld mechanical properties

	Typical (AC)	Guaranty
<b>0.2%YS (MPa)</b>	410	331min.
<b>TS (MPa)</b>	460	414min.
<b>El on 4d (%)</b>	32	22min.
<b>IV -18°C (J)</b>	82	27min.

## Approvals

<b>ABS</b>	3
<b>LR</b>	3m
<b>DNV</b>	3
<b>BV</b>	3
<b>NK<sup>a</sup></b>	KMW3
<b>CR</b>	3

Note: <sup>a</sup> AC

## Stick electrode

- Features:**
- Suitable for butt and fillet welding of thin and thick plate (up to 20mm)
  - Good mechanical properties

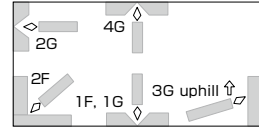
**Welding Positions:**

**Classification:** AWS A5.1 E6019

**Redrying Conditions:** 70~100°Cx0.5~1h

**Identification color:** 1st Yellow

**Polarity:** AC, DCEP, DCEN

## Packaging data

φ mm	Length mm	kg/pack	kg/carton	g/piece	carton mm
2.6	350	5	20	19	170W, 100H, 380L
3.2	350	5	20	31	170W, 105H, 380L
4.0	400	5	20	57	170W, 95H, 430L
5.0	400	5	20	85	170W, 100H, 430L
6.0	450	5	20	154	170W, 95H, 480L

## Composition (all-weld metal mass%)

	Typical (AC)	Guaranty <sup>a</sup>
<b>C</b>	0.09	0.20
<b>Si</b>	0.08	1.00
<b>Mn</b>	0.60	1.20
<b>P</b>	0.012	0.035
<b>S</b>	0.006	0.035
<b>Ni</b>	0.01	0.30
<b>Cr</b>	0.02	0.20
<b>Mo</b>	<0.01	0.30
<b>V</b>	<0.01	0.08

Note: <sup>a</sup> Single values are maximum.

## Welding parameters (A)

φ mm	1F, 1G, 2F, 2G	3G uphill, 4G
2.6	50~85	40~70
3.2	80~130	60~110
4.0	120~180	100~150
5.0	170~250	130~200
6.0	240~310	-

## All-weld mechanical properties

	Typical (AC)	Guaranty
<b>0.2%YS (MPa)</b>	420	331min.
<b>TS (MPa)</b>	470	414min.
<b>EI on 4d (%)</b>	31	22min.
<b>IV -18°C (J)</b>	80	27min.

## Approvals

<b>ABS</b>	3
<b>LR</b>	3m
<b>DNV</b>	3
<b>BV</b>	3
<b>NK</b>	KMW3
<b>CR</b>	3



## Stick electrode

**Features:** ▪ Low hydrogen type containing iron powder

**Classification:** AWS A5.1 E7016

**Redrying Conditions:** 300~350°Cx0.5~1h

**Identification color:** 1st Blue white

**Polarity:** AC, DCEP

## Welding Positions:

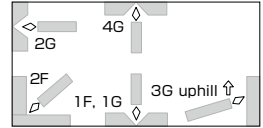

## Packaging data

φ mm	Length mm	kg/pack	kg/carton	g/piece	carton mm
2.6	350	5	20	20	170W, 110H, 380L
3.2	350	5	20	34	170W, 115H, 380L
4.0	400	5	20	60	170W, 110H, 430L
5.0	450	5	20	106	170W, 110H, 480L
6.0	450	5	20	150	170W, 110H, 480L

## Composition (all-weld metal mass%)

	Typical (AC)	Guaranty <sup>a</sup>
<b>C</b>	0.08	0.15
<b>Si</b>	0.50	0.75
<b>Mn</b>	1.01	1.60
<b>P</b>	0.013	0.035
<b>S</b>	0.003	0.035
<b>Ni</b>	0.01	0.30
<b>Cr</b>	0.02	0.20
<b>Mo</b>	<0.01	0.30
<b>V</b>	0.01	0.08
<b>Others<sup>b</sup></b>	1.05	1.75

Note: <sup>a</sup> Single values are maximum.

<sup>b</sup> Combined Limit for Mn+Ni+Cr+Mo+V

## Welding parameters (A)

φ mm	1F, 1G, 2F, 2G	3G uphill, 4G
2.6	55~85	50~80
3.2	100~140	90~130
4.0	140~190	120~180
5.0	190~250	160~210
6.0	260~320	-

## All-weld mechanical properties

	Typical (AC)		Guaranty	
<b>0.2%YS (MPa)</b>	480	410	400min.	340min.
<b>TS (MPa)</b>	550	500	483min.	450min.
<b>El on 4d (%)</b>	33	34	22min.	25min.
<b>IV -29°C (J)</b>	100	130	27min.	27min.
<b>PWHT (°C×h)</b>	AW	620x1	AW	620±15x1

## Approvals

<b>ABS</b>	3, H15
<b>LR</b>	3Ym, H15
<b>DNV</b>	3Y, H10
<b>BV</b>	3, 3Y, H15
<b>NK<sup>a)</sup></b>	KMW3, H15
<b>CR</b>	3, 3Y, H15

Note: <sup>a)</sup> AC

## Stick electrode

- Features:**
- Suitable for butt and fillet welding of heavy structures
  - Excellent mechanical properties

**Classification:** AWS A5.1 E7016

**Redrying Conditions:** 300~350°Cx0.5~1h

**Identification color:** 1st Blue white, 2nd White

**Polarity:** AC, DCEP

## Welding Positions:

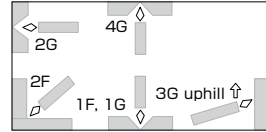

## Packaging data

φ mm	Length mm	kg/pack	kg/carton	g/piece	carton mm
2.6	350	5	20	20	170W, 110H, 380L
3.2	350	5	20	31	170W, 110H, 380L
4.0	400	5	20	54	170W, 110H, 430L
5.0	450	5	20	97	170W, 110H, 480L
6.0	450	5	20	137	170W, 110H, 480L

## Composition (all-weld metal mass%)

	Typical (AC)	Guaranty <sup>a</sup>
<b>C</b>	0.08	0.15
<b>Si</b>	0.60	0.75
<b>Mn</b>	0.94	1.60
<b>P</b>	0.011	0.035
<b>S</b>	0.006	0.035
<b>Ni</b>	0.01	0.30
<b>Cr</b>	0.02	0.20
<b>Mo</b>	<0.01	0.30
<b>V</b>	0.01	0.08
<b>Others<sup>b</sup></b>	0.98	1.75

Note: <sup>a</sup> Single values are maximum.

<sup>b</sup> Combined Limit for Mn+Ni+Cr+Mo+V

## Welding parameters (A)

φ mm	1F, 1G, 2F, 2G	3G uphill, 4G
2.6	55~85	50~80
3.2	90~130	80~120
4.0	130~180	110~170
5.0	180~240	150~200
6.0	250~310	-

## All-weld mechanical properties

	Typical (AC)		Guaranty	
<b>0.2%YS (MPa)</b>	500	420	400min.	350min.
<b>TS (MPa)</b>	570	520	483min.	460min.
<b>EI on 4d (%)</b>	32	33	22min.	25min.
<b>IV -29°C (J)</b>	120	150	27min.	27min.
<b>PWHT (°Cxh)</b>	AW	620x1	AW	620±15x1

## Approvals

<b>ABS</b>	3H10, 3Y, 3Y400
<b>LR</b>	3Ym, H15
<b>DNV</b>	3Y, H10
<b>BV</b>	3YH10
<b>NK</b>	KMW53Y40, H10
<b>CR</b>	3Y, H10

## Stick electrode

**Features:** • Better impact value  
**Classification:** AWS A5.1 E7016  
**Redrying Conditions:** 350~400°Cx1h  
**Identification color:** 1st Red, 2nd White  
**Polarity:** AC, DCEP

## Welding Positions:

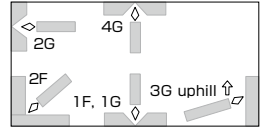

## Packaging data

φ mm	Length mm	kg/pack	kg/carton	g/piece	carton mm
3.2	350	5	20	31	170W, 120H, 380L
4.0	400	5	20	55	170W, 110H, 430L
5.0	450	5	20	96	170W, 105H, 480L
6.0	450	5	20	141	170W, 105H, 480L

## Composition (all-weld metal mass%)

	Typical (AC)	Guaranty <sup>a</sup>
<b>C</b>	0.08	0.15
<b>Si</b>	0.57	0.75
<b>Mn</b>	1.06	1.60
<b>P</b>	0.012	0.035
<b>S</b>	0.005	0.035
<b>Ni</b>	0.01	0.30
<b>Cr</b>	0.02	0.20
<b>Mo</b>	<0.01	0.30
<b>V</b>	<0.01	0.08
<b>Others<sup>b</sup></b>	1.09	1.75

Note: <sup>a</sup> Single values are maximum.

<sup>b</sup> Combined Limit for Mn+Ni+Cr+Mo+V

## Welding parameters (A)

φ mm	1F, 1G, 2F, 2G	3G uphill, 4G
3.2	90~130	80~120
4.0	130~180	110~170
5.0	180~240	150~200
6.0	250~310	-

## All-weld mechanical properties

	Typical (AC)		Guaranty	
<b>0.2%YS (MPa)</b>	500	430	400min.	370min.
<b>TS (MPa)</b>	580	530	483min.	480min.
<b>El on 4d (%)</b>	31	33	22min.	25min.
<b>IV -29°C (J)</b>	120	150	27min.	27min.
<b>PWHT (°C×h)</b>	AW	620x1	AW	620±15x1

## Approvals

NK	KMW53, H10

## Stick electrode

## Features:

- Suitable for one side welding of pipes
- Extremely good arc stability in one side welding with relatively low current

**Classification:** AWS A5.1 E7016

**Redrying Conditions:** 300~350°Cx0.5~1h

**Identification color:** 1st Blue white, 2nd Pink

**Polarity:** AC, DCEP

## Welding Positions:

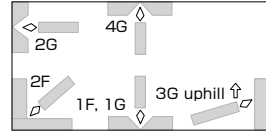

## Packaging data

φ mm	Length mm	kg/pack	kg/carton	g/piece	carton mm
2.6	350	5	20	20	170W, 110H, 380L
3.2	400	5	20	35	170W, 110H, 430L
4.0	400	5	20	53	170W, 110H, 430L

## Composition (all-weld metal mass%)

	Typical (AC)	Guaranty <sup>a</sup>
<b>C</b>	0.08	0.15
<b>Si</b>	0.64	0.75
<b>Mn</b>	0.86	1.60
<b>P</b>	0.012	0.035
<b>S</b>	0.008	0.035
<b>Ni</b>	0.01	0.30
<b>Cr</b>	0.02	0.20
<b>Mo</b>	<0.01	0.30
<b>V</b>	0.01	0.08
<b>Others<sup>b</sup></b>	0.90	1.75

Note: <sup>a</sup> Single values are maximum.

<sup>b</sup> Combined Limit for Mn+Ni+Cr+Mo+V

## Welding parameters (A)

φ mm	1F, 1G, 2F, 2G	3G uphill, 4G	Root pass <sup>c</sup>
2.6	60~90	50~80	30~80
3.2	90~130	80~120	60~110
4.0	130~180	110~170	90~140

Note: <sup>c</sup>DCEN is also suitable.

## All-weld mechanical properties

	Typical (AC)	Guaranty
<b>0.2%YS (MPa)</b>	480	400min.
<b>TS (MPa)</b>	560	483min.
<b>EI on 4d (%)</b>	31	22min.
<b>IV -29°C (J)</b>	80	27min.

## Approvals

<b>ABS</b>	3Y, MG, H10
<b>LR</b>	3Ym, MG, H15
<b>DNV</b>	3Y, H10
<b>BV</b>	3YH10
<b>NK<sup>a)</sup></b>	KMW53, H10
<b>CCS</b>	3Y, H10
<b>NAKS</b>	AWS A5.1 E7016

Note: <sup>a)</sup> AC

## Stick electrode

- Features:**
- Suitable for one side welding of pipes
  - Good arc stability in one side welding with relatively low current

**Classification:** AWS A5.5 E8016-G

**Redrying Conditions:** 350~400°Cx1h

**Identification color:** -

**Polarity:** AC, DCEP, DCEN (Root Pass only)

## Welding Positions:

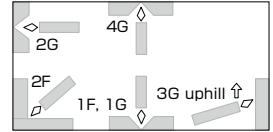

## Packaging data

φ mm	Length mm	kg/pack	kg/carton	g/piece	carton mm
2.6	350	5	20	20	170W, 110H, 380L
3.2	400	5	20	35	170W, 110H, 430L
4.0	400	5	20	53	170W, 110H, 430L

## Composition (all-weld metal mass%)

	Typical (DCEP)	Guaranty <sup>a</sup>
<b>C</b>	0.06	0.15
<b>Si</b>	0.49	0.75
<b>Mn</b>	1.70	1.40~2.25
<b>P</b>	0.015	0.030
<b>S</b>	0.005	0.030

Note: <sup>a</sup> Single values are maximum.

## Welding parameters (A)

φ mm	1F, 1G, 2F, 2G	3G uphill, 4G	Root pass <sup>b</sup>
2.6	60~90	50~80	30~80
3.2	90~130	80~120	60~110
4.0	130~180	110~170	90~140

Note: <sup>b</sup> DCEN is also suitable.

## All-weld mechanical properties

	Typical (DCEP)	Guaranty
<b>0.2%YS (MPa)</b>	570	462min.
<b>TS (MPa)</b>	620	552min.
<b>EI on 4d (%)</b>	31	19min.
<b>IV -40°C (J)</b>	110	32min.

## Approvals

<b>ABS</b>	3YQ460 H10, MG
<b>LR</b>	3Y46m, H10
<b>DNV</b>	3Y46 H10, MG
<b>BV</b>	3Y46H10 UP

## Stick electrode

**Features:** ▪ Suitable for butt and fillet welding of 520MPa high tensile steel

**Classification:** AWS A5.1 E7016

**Redrying Conditions:** 350~400°Cx1h

**Identification color:** 1st Blue, 2nd Brown

**Polarity:** AC, DCEP

## Welding Positions:

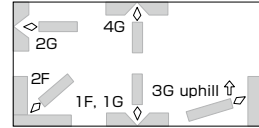

## Packaging data

φ mm	Length mm	kg/pack	kg/carton	g/piece	carton mm
2.6	350	5	20	20	170W, 125H, 380L
3.2	350	5	20	31	170W, 120H, 380L
4.0	400	5	20	55	170W, 110H, 430L
5.0	450	5	20	97	170W, 105H, 480L
6.0	450	5	20	138	170W, 105H, 480L

## Composition (all-weld metal mass%)

	Typical (AC)	Guaranty <sup>a</sup>
<b>C</b>	0.08	0.15
<b>Si</b>	0.64	0.75
<b>Mn</b>	0.81	1.60
<b>P</b>	0.011	0.035
<b>S</b>	0.003	0.035
<b>Ni</b>	0.01	0.30
<b>Cr</b>	0.03	0.20
<b>Mo</b>	0.17	0.30
<b>V</b>	0.01	0.08
<b>Others<sup>b</sup></b>	1.03	1.75

Note: <sup>a</sup> Single values are maximum.

<sup>b</sup> Combined Limit for Mn+Ni+Cr+Mo+V

## Welding parameters (A)

φ mm	1F, 1G, 2F, 2G	3G uphill, 4G
2.6	50~85	50~80
3.2	90~130	80~115
4.0	130~180	110~170
5.0	180~250	150~200
6.0	250~310	-

## All-weld mechanical properties

	Typical (AC)		Guaranty	
<b>0.2%YS (MPa)</b>	530	470	400min.	400min.
<b>TS (MPa)</b>	610	540	483min.	500min.
<b>EI on 4d (%)</b>	31	32	22min.	25min.
<b>IV -29°C (J)</b>	100	130	27min.	27min.
<b>PWHT (°C×h)</b>	AW	620x1	AW	620±15x10

## Stick electrode

- Features:**
- Suitable for butt and fillet welding of heavy structure
  - Good performance by DCEP current

**Classification:** AWS A5.1 E7018

**Redrying Conditions:** 300~350°Cx0.5~1h

**Identification color:** 1st Blue white, 2nd Blue

**Polarity:** AC, DCEP

## Welding Positions:

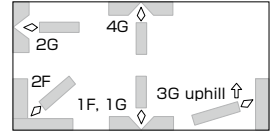

## Packaging data

φ mm	Length mm	kg/pack	kg/carton	g/piece	carton mm
2.6	350	5	20	24	170W, 105H, 380L
3.2	400	5	20	41	170W, 105H, 430L
4.0	450	5	20	69	170W, 105H, 480L
5.0	450	5	20	106	170W, 105H, 480L

## Composition (all-weld metal mass%)

	Typical (AC)	Guaranty <sup>a</sup>
<b>C</b>	0.07	0.15
<b>Si</b>	0.59	0.75
<b>Mn</b>	0.97	1.60
<b>P</b>	0.013	0.035
<b>S</b>	0.007	0.035
<b>Ni</b>	0.02	0.30
<b>Cr</b>	0.03	0.20
<b>Mo</b>	<0.01	0.30
<b>V</b>	0.01	0.08
<b>Others<sup>b</sup></b>	1.03	1.75

Note: <sup>a</sup> Single values are maximum.

<sup>b</sup> Combined Limit for Mn+Ni+Cr+Mo+V

## Welding parameters (A)

φ mm	1F, 1G, 2F, 2G	3G uphill, 4G
2.6	65~95	60~90
3.2	90~130	80~120
4.0	130~190	110~170
5.0	190~250	165~210

## All-weld mechanical properties

	Typical (AC)		Guaranty	
<b>0.2%YS (MPa)</b>	500	420	400min.	350min.
<b>TS (MPa)</b>	560	520	483min.	460min.
<b>EI on 4d (%)</b>	31	32	22min.	25min.
<b>IV -29°C (J)</b>	110	140	27min.	27min.
<b>PWHT (°Cxh)</b>	AW	620x1	AW	620±15x1

## Approvals

<b>ABS</b>	3Y, H10
<b>LR</b>	3Ym, H15
<b>DNV</b>	3Y, H10
<b>NK</b>	KMW53, H10

## Stick electrode

## Features:

- Suitable for flat and horizontal fillet welding
- Iron powder low hydrogen type

## Welding Positions:

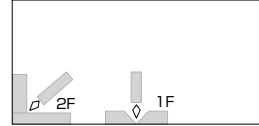

**Classification:** AWS A5.1 E7018

**Redrying Conditions:** 300~350°Cx0.5~1h

**Identification color:** 1st Silver, 2nd Orange

**Polarity:** AC, DCEP

## Packaging data

φ mm	Length mm	kg/pack	kg/carton	g/piece	carton mm
6.0	550	5	20	210	170W, 75H, 580L
6.4	700	10	20	295	170W, 65H, 730L
8.0	450, 550, 700	5, 10	20	268, 327, 416	170W, 80~115H, 480~730L

## Composition (all-weld metal mass%)

	Typical (AC)	Guaranty <sup>a</sup>
<b>C</b>	0.11	0.15
<b>Si</b>	0.40	0.75
<b>Mn</b>	1.12	1.60
<b>P</b>	0.014	0.035
<b>S</b>	0.004	0.035
<b>Ni</b>	0.02	0.30
<b>Cr</b>	0.03	0.20
<b>Mo</b>	<0.01	0.30
<b>V</b>	0.01	0.08
<b>Others<sup>b</sup></b>	1.18	1.75

Note: <sup>a</sup> Single values are maximum.

<sup>b</sup> Combined Limit for Mn+Ni+Cr+Mo+V

## Welding parameters (A)

φ mm	1F, 2F
6.0	250~300
6.4	270~320
8.0	350~400

## All-weld mechanical properties

	Typical (AC)	Guaranty
<b>0.2%YS (MPa)</b>	480	400min.
<b>TS (MPa)</b>	550	483min.
<b>El on 4d (%)</b>	30	22min.
<b>IV -29°C (J)</b>	74	27min.

## Approvals

<b>ABS</b>	3, 3Y, H10
<b>LR</b>	3Ym, 3YG, H15
<b>DNV</b>	3Y, H15
<b>BV</b>	3, 3Y, H10
<b>NK<sup>a)</sup></b>	KMW53, H10

Note: <sup>a)</sup> AC



## Stick electrode

**Features:** • Low hydrogen type for tack welding

**Classification:** AWS A5.1 E7048

**Redrying Conditions:** 300~350°Cx0.5~1h

**Identification color:** 1st Red

**Polarity:** AC, DCEP

## Welding Positions:

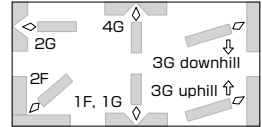

## Packaging data

φ mm	Length mm	kg/pack	kg/carton	g/piece	carton mm
3.2	350	5	20	36	170W, 115H, 380L
4.0	400	5	20	60	170W, 105H, 430L
5.0	450	5	20	96	170W, 105H, 480L

## Composition (all-weld metal mass%)

	Typical (AC)	Guaranty <sup>a</sup>
<b>C</b>	0.08	0.15
<b>Si</b>	0.47	0.90
<b>Mn</b>	1.04	1.60
<b>P</b>	0.012	0.035
<b>S</b>	0.002	0.035
<b>Ni</b>	0.01	0.30
<b>Cr</b>	0.02	0.20
<b>Mo</b>	<0.01	0.30
<b>V</b>	<0.01	0.08
<b>Others<sup>b</sup></b>	1.07	1.75

Note: <sup>a</sup> Single values are maximum.

<sup>b</sup> Combined Limit for Mn+Ni+Cr+Mo+V

## Welding parameters (A)

φ mm	All position (1F, 1G, 2F, 2G, 3G uphill, 4G) & 3G downhill
3.2	110~160
4.0	160~220
5.0	200~260

## All-weld mechanical properties

	Typical (AC)	Guaranty
<b>0.2%YS (MPa)</b>	450	400min.
<b>TS (MPa)</b>	540	483min.
<b>El on 4d (%)</b>	32	22min.
<b>IV -29°C (J)</b>	110	27min.
<b>PWHT</b>	AW	AW

## Approvals

<b>ABS</b>	3, 3Y, 3Y400, H10
<b>LR</b>	3Ym, H15
<b>DNV</b>	3Y, H10
<b>BV</b>	3, 3Y, H10
<b>NK</b>	KMW53Y40, H10
<b>CR<sup>a)</sup></b>	3, 3Y, H10

Note: <sup>a)</sup> AC

## Stick electrode

- Features:**
- Suitable for butt welding of pipes
  - Excellent usability in vertical downward welding
  - Good mechanical properties

**Classification:** AWS A5.1 E7048

**Redrying Conditions:** 350~400°Cx1h

**Identification color:** 1st Orange, 2nd Black

**Polarity:** AC, DCEP

## Welding Positions:

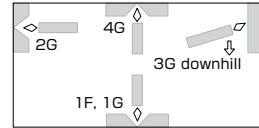

## Packaging data

φ mm	Length mm	kg/pack	kg/carton	g/piece	carton mm
3.2	350	5	20	33	170W, 110H, 380L
4.0	400	5	20	56	170W, 110H, 430L

## Composition (all-weld metal mass%)

	Typical (AC)	Guaranty <sup>a</sup>
<b>C</b>	0.06	0.15
<b>Si</b>	0.56	0.90
<b>Mn</b>	1.18	1.60
<b>P</b>	0.012	0.035
<b>S</b>	0.005	0.035
<b>Ni</b>	0.01	0.30
<b>Cr</b>	0.03	0.20
<b>Mo</b>	0.01	0.30
<b>V</b>	<0.01	0.08
<b>Others<sup>b</sup></b>	1.23	1.75

Note: <sup>a</sup> Single values are maximum.

<sup>b</sup> Combined Limit for Mn+Ni+Cr+Mo+V

## Welding parameters (A)

φ mm	1F, 1G, 2G	3G uphill, 4G	3G downhill
3.2	80~140	80~120	80~140
4.0	130~210	110~160	130~210

## All-weld mechanical properties

	Typical (AC)	Guaranty
<b>0.2%YS (MPa)</b>	490	400min.
<b>TS (MPa)</b>	580	483min.
<b>EI on 4d (%)</b>	30	22min.
<b>IV -29°C (J)</b>	100	27min.

## Stick electrode

- Features:**
- Suitable for butt welding of pipes
  - Excellent usability in vertical downward welding

**Classification:** AWS A5.5 E7010-P1

**Identification color:** 1st Brown, 2nd Black

**Polarity:** DCEP

## Welding Positions:

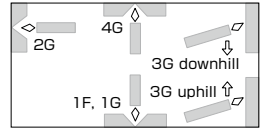

## Packaging data

$\phi$ mm	Length mm	kg/pack	kg/carton	g/piece	carton mm
2.4	300	2	20	13	300W, 100H, 330L
3.2	350	5	20	27	175W, 115H, 380L
4.0	350	5	20	40	175W, 115H, 380L
4.8	350	5	20	58	175W, 115H, 380L

## Composition (all-weld metal mass%)

	Typical	Guaranty <sup>a</sup>
<b>C</b>	0.14	0.20
<b>Si</b>	0.10	0.60
<b>Mn</b>	1.01	1.20
<b>P</b>	0.01	0.03
<b>S</b>	0.01	0.03
<b>Ni</b>	0.01	1.00
<b>Cr</b>	0.02	0.30
<b>Mo</b>	<0.01	0.50
<b>V</b>	<0.01	0.10

Note: <sup>a</sup> Single values are maximum.

## Welding parameters (A)

$\phi$ mm	1F, 1G, 2G	3G uphill, 4G	3G downhill
2.4	40~70	40~70	40~70
3.2	60~120	60~120	70~120
4.0	90~170	80~160	100~170
4.8	130~210	120~200	150~210

## All-weld mechanical properties

	Typical	Guaranty
<b>0.2%YS (MPa)</b>	470	414min.
<b>TS (MPa)</b>	570	483min.
<b>El on 4d (%)</b>	30	22min.
<b>IV -29°C (J)</b>	61	27min.

## Stick electrode

- Features:**
- Suitable for butt welding of pipes
  - Excellent usability in vertical downward welding

**Classification:** AWS A5.5 E8010-P1

**Identification color:** 1st Blue white

**Polarity:** DCEP

## Welding Positions:

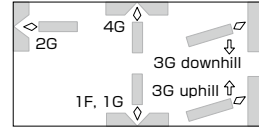

## Packaging data

φ mm	Length mm	kg/pack	kg/carton	g/piece	carton mm
3.2	350	5	20	26	175W, 115H, 380L
4.0	350	5	20	40	175W, 115H, 380L
4.8	350	5	20	58	175W, 115H, 380L

## Composition (all-weld metal mass%)

	Typical	Guaranty <sup>a</sup>
<b>C</b>	0.15	0.20
<b>Si</b>	0.12	0.60
<b>Mn</b>	1.05	1.20
<b>P</b>	0.01	0.03
<b>S</b>	0.01	0.03
<b>Ni</b>	0.01	1.00
<b>Cr</b>	0.03	0.30
<b>Mo</b>	0.27	0.50
<b>V</b>	<0.01	0.10

Note: <sup>a</sup> Single values are maximum.

## Welding parameters (A)

φ mm	1F, 1G, 2G	3G uphill, 4G	3G downhill
3.2	60~120	70~120	60~120
4.0	90~170	100~170	80~160
4.8	130~210	150~210	120~200

## All-weld mechanical properties

	Typical	Guaranty
<b>0.2%YS (MPa)</b>	520	462min.
<b>TS (MPa)</b>	620	552min.
<b>EI on 4d (%)</b>	28	19min.
<b>IV -29°C (J)</b>	54	27min.

## Stick electrode

- Features:**
- Suitable for butt and fillet welding of heavy structure
  - Good performance by DCEP current

**Classification:** AWS A5.5 E8018-G

**Redrying Conditions:** 350~400°Cx1h

**Identification color:** -

**Polarity:** AC, DCEP

## Welding Positions:

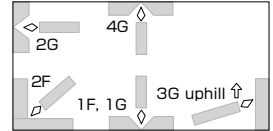

## Packaging data

$\phi$ mm	Length mm	kg/pack	kg/carton	g/piece	carton mm
2.6	350	5	20	24	170W, 105H, 380L
3.2	400	5	20	41	170W, 105H, 430L
4.0	450	5	20	69	170W, 105H, 480L

## Composition (all-weld metal mass%)

	Typical (DCEP)	Guaranty <sup>a</sup>
<b>C</b>	0.07	0.15
<b>Si</b>	0.34	0.75
<b>Mn</b>	1.74	1.40~2.25
<b>P</b>	0.012	0.030
<b>S</b>	0.007	0.030

Note: <sup>a</sup> Single values are maximum.

## Welding parameters (A)

$\phi$ mm	1F, 1G, 2F, 2G	3G uphill, 4G
2.6	65~95	60~90
3.2	90~130	80~120
4.0	130~190	110~170

## All-weld mechanical properties

	Typical (DCEP)	Guaranty
<b>0.2%YS (MPa)</b>	540	462min.
<b>TS (MPa)</b>	615	552min.
<b>El on 4d (%)</b>	30	19min.
<b>IV -40°C (J)</b>	150	32min.

## Approvals

<b>ABS</b>	3YQ460 H10, MG
<b>LR</b>	3Y46m, H10
<b>DNV</b>	3Y46 H10, MG
<b>BV</b>	3Y46H10 UP

## Stick electrode

**Features:** ▪ Suitable for butt and fillet welding of 520MPa high tensile steel

**Redrying Conditions:** 300~350°Cx0.5~1h

**Identification color:** 1st Blue white, 2nd Green

**Polarity:** AC, DCEP

## Welding Positions:

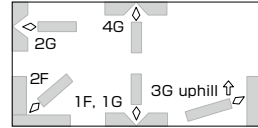

## Packaging data

φ mm	Length mm	kg/pack	kg/carton	g/piece	carton mm
3.2	350	5	20	33	170W, 120H, 380L
4.0	400	5	20	58	170W, 110H, 430L
5.0	450	5	20	102	170W, 110H, 480L
6.0	450	5	20	145	170W, 110H, 480L

## Composition (all-weld metal mass%)

	Typical (AC)	Guaranty <sup>a</sup>
<b>C</b>	0.08	0.05~0.10
<b>Si</b>	0.58	0.30~0.75
<b>Mn</b>	1.30	1.00~1.50
<b>P</b>	0.01	0.03
<b>S</b>	0.01	0.03
<b>Ni</b>	0.01	0.30
<b>Cr</b>	0.03	0.20
<b>Mo</b>	<0.01	0.30
<b>V</b>	0.01	0.08

Note: <sup>a</sup>Single values are maximum.

## Welding parameters (A)

φ mm	1F, 1G, 2F, 2G	3G uphill, 4G
3.2	90~130	80~120
4.0	140~190	120~180
5.0	190~250	-
6.0	250~320	-

## All-weld mechanical properties

	Typical (AC)	Guaranty
<b>0.2%YS (MPa)</b>	510	393min.
<b>TS (MPa)</b>	600	483min.
<b>EI on 4d (%)</b>	29	25min.
<b>IV -29°C (J)</b>	110	-

## Stick electrode

- Features:**
- Suitable for butt welding of pipes
  - Excellent usability in vertical downward welding
  - Good mechanical properties

**Classification:** AWS A5.5 E8018-G

**Redrying Conditions:** 350~400°Cx1h

**Identification color:** 1st Yellowish green, 2nd Yellowish green

**Polarity:** AC, DCEP

## Welding Positions:

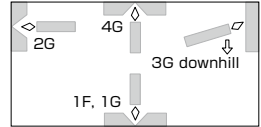

## Packaging data

φ mm	Length mm	kg/pack	kg/carton	g/piece	carton mm
3.2	350	5	20	31	170W, 110H, 380L
4.0	400	5	20	56	170W, 110H, 430L
4.5	400	5	20	68	170W, 110H, 430L

## Composition (all-weld metal mass%)

	Typical (AC)	Guaranty <sup>a</sup>
<b>C</b>	0.06	0.05~0.10
<b>Si</b>	0.55	0.30~0.75
<b>Mn</b>	1.20	1.00~1.40
<b>P</b>	0.01	0.03
<b>S</b>	0.01	0.03
<b>Ni</b>	0.53	0.40~0.80
<b>Mo</b>	0.07	0.30

Note: <sup>a</sup> Single values are maximum.

## Welding parameters (A)

φ mm	1F, 1G, 2G	4G	3G downhill
3.2	80~140	80~120	80~140
4.0	130~200	110~160	130~200
4.5	160~250	130~190	160~250

## All-weld mechanical properties

	Typical (AC)	Guaranty
<b>0.2%YS (MPa)</b>	510	462min.
<b>TS (MPa)</b>	620	552min.
<b>El on 4d (%)</b>	30	19min.
<b>IV -18°C (J)</b>	120	-

## Stick electrode

- Features:**
- Suitable for butt welding of pipes
  - Excellent usability in vertical downward welding
  - Good mechanical properties

**Classification:** AWS A5.5 E9018-G

**Redrying Conditions:** 350~400°Cx1h

**Identification color:** 1st Blue, 2nd Silver

**Polarity:** AC, DCEP

## Welding Positions:

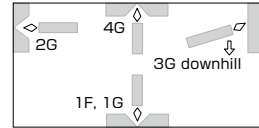

## Packaging data

φ mm	Length mm	kg/pack	kg/carton	g/piece	carton mm
3.2	350	5	20	31	170W, 110H, 380L
4.0	400	5	20	56	170W, 110H, 430L
4.5	400	5	20	67	170W, 110H, 430L

## Composition (all-weld metal mass%)

	Typical (AC)	Guaranty <sup>a</sup>
<b>C</b>	0.06	0.05~0.10
<b>Si</b>	0.61	0.30~0.75
<b>Mn</b>	1.27	1.00~1.50
<b>P</b>	0.01	0.03
<b>S</b>	<0.01	0.03
<b>Ni</b>	1.17	0.90~1.40
<b>Mo</b>	0.18	0.40

## Welding parameters (A)

φ mm	1F, 1G, 2G	4G	3G downhill
3.2	80~140	80~120	80~140
4.0	130~200	110~160	130~200
4.5	160~250	130~190	160~250

Note: <sup>a</sup>Single values are maximum.

## All-weld mechanical properties

	Typical (AC)	Guaranty
<b>0.2%YS (MPa)</b>	560	531min.
<b>TS (MPa)</b>	660	621min.
<b>EI on 4d (%)</b>	30	17min.
<b>IV -18°C (J)</b>	130	-



## Stick electrode

**Features:**

- Suitable for flat and horizontal fillet welding
- Lime titania type

## Welding Positions:

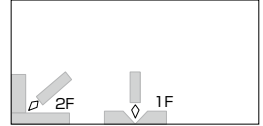

**Classification:** AWS -

**Redrying Conditions:** 70~100°Cx0.5~1h

**Identification color:** 1st Purple, 2nd Orange

**Polarity:** AC, DCEP, DCEN

## Packaging data

φ mm	Length mm	kg/pack	kg/carton	g/piece	carton mm
4.0	450	5	20	76	170W, 90H, 480L
4.5	550, 700	5	20	138, 175	170W, 60~75H, 580~730L
5.0	450, 550, 700	5, 10	20	130, 159, 203	170W, 60~95H, 480~730L
5.5	450, 550, 700	5, 10	20	153, 187, 239	170W, 65~95H, 480~730L
6.0	450, 550, 700	5, 10	20	176, 215, 273	170W, 65~95H, 480~730L
6.4	450, 550, 700	5, 10	20	189, 231, 294	170W, 60~95H, 480~730L
7.0	700	10	20	350	170W, 60H, 730L

## Composition (all-weld metal mass%)

	Typical (AC)	Guaranty <sup>a</sup>
<b>C</b>	0.07	0.13
<b>Si</b>	0.39	0.10~0.70
<b>Mn</b>	0.94	0.60~1.25
<b>P</b>	0.017	0.030
<b>S</b>	0.009	0.025
<b>Ni</b>	0.01	0.30
<b>Cr</b>	0.02	0.20
<b>Mo</b>	<0.01	0.30
<b>V</b>	0.01	0.08

Note: <sup>a</sup> Single values are maximum.

## Welding parameters (A)

φ mm	1F, 2F
4.0	135~195
4.5	170~220
5.0	200~240
5.5	230~280
6.0	260~310
6.4	280~330
7.0	300~350

## All-weld mechanical properties

	Typical (AC)	Guaranty
<b>0.2%YS (MPa)</b>	480	390min.
<b>TS (MPa)</b>	530	490min.
<b>EI on 4d (%)</b>	29	16min.
<b>IV 0°C (J)</b>	74	47min.

## Approvals

<b>ABS</b>	3, 3Y
<b>LR</b>	3Ym, 3YG
<b>DNV</b>	3Y, MG
<b>BV</b>	3Y
<b>NK</b>	KMW53
<b>CR</b>	3Y

# MX-100T

## Flux cored wire

- Features:**
- Suitable for thin plates (e.g., 0.8mm)
  - Excellent arc stability in low current range (50~180A) for short circuiting welding

**Classification:** AWS A5.18 E70C-6C/6M

**Shielding gas:** CO<sub>2</sub> or Ar-CO<sub>2</sub>

**Polarity:** DCEP

### Welding Positions:

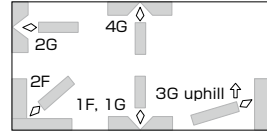

## Packaging data

φ mm	Spool	Drum
1.2	20kg	250kg
1.4	20kg	250kg
<b>Volume mm</b>	300W, 110H, 300L	530 φ, 820H

## Composition (all-weld metal mass%)

	Typical (CO <sub>2</sub> )	Guaranty <sup>a</sup>
<b>C</b>	0.08	0.12
<b>Si</b>	0.49	0.90
<b>Mn</b>	1.53	1.75
<b>P</b>	0.01	0.03
<b>S</b>	0.01	0.03
<b>Ni</b>	0.01	0.50
<b>Cr</b>	0.02	0.20
<b>Mo</b>	0.01	0.30
<b>V</b>	<0.01	0.08
<b>Cu</b>	0.02	0.50

## Welding parameters (A)

φ mm	1F, 1G, 2F, 2G	3G uphill, 4G
1.2	50~300	50~180
1.4	80~400	70~180

Note: <sup>a</sup>Single values are maximum.

## All-weld mechanical properties

	Typical (CO <sub>2</sub> )	Guaranty
<b>0.2%YS (MPa)</b>	480	400min.
<b>TS (MPa)</b>	560	490min.
<b>EI on 4d (%)</b>	31	22min.
<b>IV -29°C (J)</b>	62	27min.

## Approvals

	CO <sub>2</sub>	Ar-CO <sub>2</sub>
<b>ABS</b>	3YSA, H5	-
<b>LR</b>	3YS, H5	-
<b>DNV</b>	III YMS (H5)	-
<b>BV</b>	SA3YM (H5)	-
<b>CR</b>	3YS-HH	-

# MX-A100

## Flux cored wire

- Features:**
- Better arc stability and wider optimum current range for spray transfer arc with less spattering than solid wire

**Classification:** AWS A5.18 E70C-6M

**Shielding gas:** Ar-CO<sub>2</sub>

**Polarity:** DCEP

### Welding Positions:

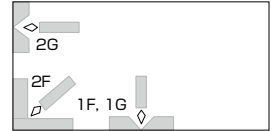

## Packaging data

φ mm	Spool		Drum	
	15kg	20kg	200kg	-
1.2	15kg	20kg	200kg	-
1.4	15kg	20kg	-	250kg
1.6	15kg	20kg	-	250kg
<b>Volume mm</b>	300W, 110H, 300L		530 φ , 820H	680 φ , 770H

## Composition (all-weld metal mass%)

	Typical	Guaranty <sup>a</sup>
<b>C</b>	0.05	0.12
<b>Si</b>	0.74	0.90
<b>Mn</b>	1.58	1.75
<b>P</b>	0.01	0.03
<b>S</b>	0.01	0.03
<b>Ni</b>	0.02	0.50
<b>Cr</b>	0.03	0.20
<b>Mo</b>	0.01	0.30
<b>V</b>	<0.01	0.08
<b>Cu</b>	0.02	0.50

Note: <sup>a</sup> Single values are maximum.

## Welding parameters (A)

φ mm	1F, 1G	2F, 2G
1.2	150~350	150~300
1.4	200~450	200~400
1.6	250~500	250~450

## All-weld mechanical properties

	Typical	Guaranty
<b>0.2%YS (MPa)</b>	450	400min.
<b>TS (MPa)</b>	550	483min.
<b>EI on 4d (%)</b>	33	22min.
<b>IV -40°C (J)</b>	71	27min.

## Approvals

<b>ABS</b>	4YSA, H5
<b>LR</b>	4YS, H5
<b>DNV</b>	IVYMS, H5
<b>BV</b>	SA4YM, H5

## Flux cored wire

- Features:**
- Suitable for flat and horizontal fillet welding
  - A large leg length of about 9mm in horizontal fillet

### Welding Positions:

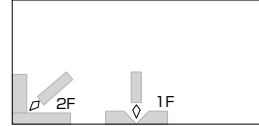

**Classification:** AWS A5.20 E70T-1C

**Shielding gas:** CO<sub>2</sub>

**Polarity:** DCEP

### Packaging data

φ mm	Spool	Drum
1.2	12.5kg, 15kg, 20kg	-
1.4	12.5kg, 15kg, 20kg	200kg
<b>Volume mm</b>	300W, 110H, 300L	530 φ, 820H

### Composition (all-weld metal mass%)

	Typical	Guaranty <sup>a</sup>
<b>C</b>	0.05	0.12
<b>Si</b>	0.51	0.90
<b>Mn</b>	1.50	1.75
<b>P</b>	0.01	0.03
<b>S</b>	0.01	0.03
<b>Ni</b>	0.01	0.50
<b>Cr</b>	0.03	0.20
<b>Mo</b>	0.01	0.30
<b>V</b>	0.01	0.08
<b>Cu</b>	0.01	0.35

Note: <sup>a</sup>Single values are maximum.

### Welding parameters (A)

φ mm	1F	2F
1.2	200~320	200~300
1.4	230~400	230~360

### All-weld mechanical properties

	Typical	Guaranty
<b>0.2%YS (MPa)</b>	490	400min.
<b>TS (MPa)</b>	560	490~655
<b>EI on 4d (%)</b>	28	22min.
<b>IV -18°C (J)</b>	60	27min.

### Approvals

<b>ABS</b>	3YSA
<b>LR</b>	3YS, H10
<b>DNV</b>	III YMS
<b>BV</b>	SA3YM
<b>NK</b>	KSW53G (C)

# MX-100

## Flux cored wire

**Features:**      ▪ Suitable for butt and fillet welding

**Classification:** AWS A5.20 E70T-1C

**Shielding gas:** CO<sub>2</sub>

**Polarity:**        DCEP

### Welding Positions:

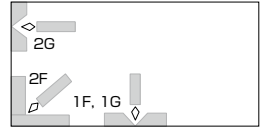

### Packaging data

φ mm	Spool	Drum
1.2	20kg	-
1.4	15kg, 20kg	250kg
1.6	20kg	-
2.0	20kg	-
<b>Volume mm</b>	300W, 110H, 300L	530 φ , 820H

### Composition (all-weld metal mass%)

	Typical	Guaranty <sup>a</sup>
<b>C</b>	0.05	0.12
<b>Si</b>	0.68	0.90
<b>Mn</b>	1.48	1.75
<b>P</b>	0.01	0.03
<b>S</b>	0.01	0.03
<b>Ni</b>	0.02	0.50
<b>Cr</b>	0.03	0.20
<b>Mo</b>	0.01	0.30
<b>V</b>	<0.01	0.08
<b>Cu</b>	0.02	0.35

Note: <sup>a</sup> Single values are maximum.

### Welding parameters (A)

φ mm	1F, 1G	2F, 2G
1.2	200~350	200~300
1.4	250~450	250~400
1.6	300~500	300~450
2.0	400~600	400~500

### All-weld mechanical properties

	Typical	Guaranty
<b>0.2%YS (MPa)</b>	510	400min.
<b>TS (MPa)</b>	580	490~655
<b>El on 4d (%)</b>	30	22min.
<b>IV -18°C (J)</b>	50	27min.

### Approvals

<b>ABS</b>	2YSA
<b>LR</b>	2YS, H10
<b>DNV</b>	II YMS
<b>BV</b>	SA2YM
<b>NK</b>	KSW52G (C)
<b>CR</b>	2YS

## Flux cored wire

**Features:** ▪ Excellent porosity resistibility to inorganic zinc primer

**Classification:** AWS A5.20 E70T-1C

**Shielding gas:** CO<sub>2</sub>

**Polarity:** DCEP

## Welding Positions:

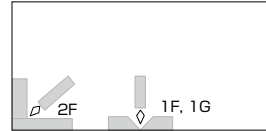

## Packaging data

φ mm	Spool		Drum	
	1.2	15kg	20kg	250kg
1.4	15kg	20kg	250kg	-
1.6	-	20kg	-	350kg
<b>Volume mm</b>	300W, 110H, 300L		530 φ, 820H	600 φ, 770H

## Composition (all-weld metal mass%)

	Typical	Guaranty <sup>a</sup>
<b>C</b>	0.05	0.12
<b>Si</b>	0.50	0.90
<b>Mn</b>	1.50	1.75
<b>P</b>	0.01	0.03
<b>S</b>	0.01	0.03
<b>Ni</b>	0.01	0.50
<b>Cr</b>	0.03	0.20
<b>Mo</b>	0.01	0.30
<b>V</b>	0.01	0.08
<b>Cu</b>	0.02	0.35

Note: <sup>a</sup> Single values are maximum.

## Welding parameters (A)

φ mm	1F, 1G	2F
1.2	150~300	180~300
1.4	170~400	200~350
1.6	200~450	270~400

## All-weld mechanical properties

	Typical	Guaranty
<b>0.2%YS (MPa)</b>	530	400min.
<b>TS (MPa)</b>	590	490~655
<b>EI on 4d (%)</b>	29	22min.
<b>IV -18°C (J)</b>	55	27min.

## Approvals

<b>ABS</b>	2YSA, 2Y400SA, H5
<b>LR</b>	2YS, 2YM, H5
<b>DNV</b>	II Y40MS, H5
<b>BV</b>	SA2Y40M, H5
<b>NK</b>	KSW52Y40G (C), H5
<b>CR</b>	2YSM, HH
<b>KR</b>	2YSG (C), H10
<b>CCS</b>	2YS, H5

# MX-200H

## Flux cored wire

- Features:**
- Suitable for horizontal fillet welding by high speed tandem method (150cm/min)
  - Excellent porosity resistibility to inorganic zinc primer

**Classification:** AWS A5.20 E70T-1C

**Shielding gas:** CO<sub>2</sub>

**Polarity:** DCEP

## Welding Positions:

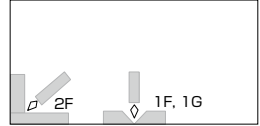

## Packaging data

φ mm	Drum
1.4	200kg, 250kg
1.6	200kg, 250kg
<b>Volume mm</b>	530 φ , 820H

## Composition (all-weld metal mass%)

	Typical	Guaranty <sup>a</sup>
<b>C</b>	0.06	0.12
<b>Si</b>	0.55	0.90
<b>Mn</b>	1.55	1.75
<b>P</b>	0.01	0.03
<b>S</b>	0.01	0.03
<b>Ni</b>	0.01	0.50
<b>Cr</b>	0.02	0.20
<b>Mo</b>	0.01	0.30
<b>V</b>	0.01	0.08
<b>Cu</b>	0.02	0.35

Note: <sup>a</sup>Single values are maximum.

## Welding parameters (A)

φ mm	1F, 1G, 2F
1.4	200~450
1.6	250~500

## All-weld mechanical properties

	Typical	Guaranty
<b>0.2%YS (MPa)</b>	500	400min.
<b>TS (MPa)</b>	600	490~655
<b>El on 4d (%)</b>	27	22min.
<b>IV -18°C (J)</b>	90	27min.

## Approvals

	Single	Tandem
<b>ABS</b>	3Y400SA, H5	3Y400A, H5
<b>LR</b>	3YS, H5	3YM, H5
<b>DNV</b>	III YS	III YM
<b>BV</b>	SA3Y40M, H5	A3Y40M
<b>NK</b>	KSW53Y40G (C)	KAW53Y40G (C)
<b>CCS</b>	-	3YM

## Flux cored wire

- Features:**
- Excellent porosity resistibility to inorganic zinc primer
  - Excellent impact value at low temperatures down to -29°C

### Welding Positions:

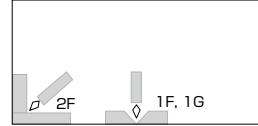

**Classification:** AWS A5.20 E70T-9C

**Shielding gas:** CO<sub>2</sub>

**Polarity:** DCEP

## Packaging data

φ mm	Spool
1.2	15kg, 20kg
Volume mm	300W, 110H, 300L

## Composition (all-weld metal mass%)

	Typical	Guaranty <sup>a</sup>
<b>C</b>	0.04	0.12
<b>Si</b>	0.51	0.90
<b>Mn</b>	1.48	1.75
<b>P</b>	0.01	0.03
<b>S</b>	0.01	0.03
<b>Ni</b>	0.01	0.50
<b>Cr</b>	0.03	0.20
<b>Mo</b>	0.01	0.30
<b>V</b>	0.01	0.08
<b>Cu</b>	0.02	0.35

## Welding parameters (A)

φ mm	1F, 1G	2F
1.2	150~300	180~300

Note: <sup>a</sup> Single values are maximum.

## All-weld mechanical properties

	Typical	Guaranty
<b>0.2%YS (MPa)</b>	540	400min.
<b>TS (MPa)</b>	600	490~655
<b>EI on 4d (%)</b>	30	22min.
<b>IV -29°C (J)</b>	70	27min.

## Approvals

<b>ABS</b>	4Y400SA, H5
<b>LR</b>	4Y40S, H5
<b>DNV</b>	IVY40MS, H5
<b>BV</b>	SA4Y40M, H5
<b>NK</b>	KSW54Y40G (C), H5



# MX-A200

## Flux cored wire

- Features:**
- Suitable for flat and horizontal fillet welding
  - Excellent porosity resistibility to inorganic zinc primer

**Classification:** AWS A5.20 E70T-1M

**Shielding gas:** Ar-CO<sub>2</sub>

**Polarity:** DCEP

## Welding Positions:

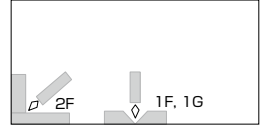

## Packaging data

φ mm	Spool	Drum
1.1	-	250kg
1.2	15kg	-
1.3	20kg	-
<b>Volume mm</b>	300W, 110H, 300L	530φ, 820H

## Composition (all-weld metal mass%)

	Typical	Guaranty <sup>a</sup>
<b>C</b>	0.05	0.12
<b>Si</b>	0.56	0.90
<b>Mn</b>	1.52	1.75
<b>P</b>	0.01	0.03
<b>S</b>	0.01	0.03
<b>Ni</b>	0.01	0.50
<b>Cr</b>	0.02	0.20
<b>Mo</b>	0.01	0.30
<b>V</b>	0.01	0.08
<b>Cu</b>	0.02	0.35

Note: <sup>a</sup> Single values are maximum.

## Welding parameters (A)

φ mm	1F, 1G	2F
1.1	150~300	180~300
1.2	150~300	180~300
1.3	170~400	200~350

## All-weld mechanical properties

	Typical	Guaranty
<b>0.2%YS (MPa)</b>	520	400min.
<b>TS (MPa)</b>	590	490~655
<b>EI on 4d (%)</b>	29	22min.
<b>IV -18°C (J)</b>	67	27min.

## Approvals

<b>ABS</b>	3YSA, H5
<b>LR</b>	3YS, H5
<b>DNV</b>	III YMS, H5

# DW-50

## Flux cored wire

**Features:** • Excellent usability with soft and stable arc, less fume and spattering, good bead appearance and smooth slag removal

**Classification:** AWS A5.20 E71T-1C/1M, -9C/9M

**Shielding gas:** CO<sub>2</sub> or Ar-CO<sub>2</sub> mixture

**Polarity:** DCEP

### Welding Positions:

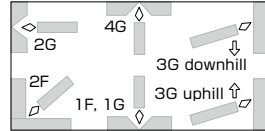

## Packaging data

φ mm	Spool			Drum
1.2	5kg	15kg	20kg	250kg
1.6	-	15kg	20kg	250kg
<b>Volume mm</b>	220W, 130H, 435L/4pcs	300W, 110H, 300L		530 φ , 820H

## Composition (all-weld metal mass%)

	Typical (CO <sub>2</sub> )	Guaranty <sup>a</sup>
<b>C</b>	0.04	0.12
<b>Si</b>	0.67	0.90
<b>Mn</b>	1.29	1.75
<b>P</b>	0.01	0.03
<b>S</b>	0.01	0.03
<b>Ni</b>	0.01	0.50
<b>Cr</b>	0.03	0.20
<b>Mo</b>	0.01	0.30
<b>V</b>	0.02	0.08
<b>Cu</b>	0.02	0.35

Note: <sup>a</sup> Single values are maximum.

## Welding parameters (A)

φ mm	1F, 1G, 2F, 2G	3G uphill, 4G	3G downhill
1.2	120~250	120~250	200~250
1.6	180~340	180~280	250~300

## All-weld mechanical properties

	Typical (CO <sub>2</sub> )	Guaranty
<b>0.2%YS (MPa)</b>	510	400min.
<b>TS (MPa)</b>	582	490~655
<b>EI on 4d (%)</b>	27	22min.
<b>IV -29°C (J)</b>	71	27min.

## Approvals

<b>ABS</b>	3YSA, H5
<b>LR</b>	3YS, H5
<b>DNV</b>	III YMS (H5)
<b>NK<sup>c)</sup></b>	KSW53G (C), H5
<b>CWB</b>	E491T-9C-H8, E491T-9M-H8

Note: <sup>c)</sup> CO<sub>2</sub>

## Flux cored wire

**Features:** ▪ Soft and stable arc, less fume and spattering, smooth bead appearance, and good slag removal

**Classification:** AWS A5.20 E71T-1C

**Shielding gas:** CO<sub>2</sub>

**Polarity:** DCEP

## Welding Positions:

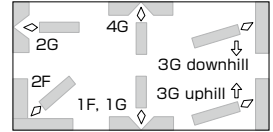

## Packaging data

φ mm	Spool			Drum	
	12.5kg	15kg	20kg	250kg	-
1.2	12.5kg	15kg	20kg	250kg	-
1.4	-	15kg	20kg	250kg	350kg
1.6	-	15kg	20kg	-	350kg
<b>Volume mm</b>	300W, 110H, 300L			530 φ, 820H	680 φ, 770H

## Composition (all-weld metal mass%)

	Typical	Guaranty <sup>a</sup>
<b>C</b>	0.05	0.12
<b>Si</b>	0.45	0.90
<b>Mn</b>	1.35	1.75
<b>P</b>	0.01	0.03
<b>S</b>	0.01	0.03
<b>Ni</b>	0.01	0.50
<b>Cr</b>	0.02	0.20
<b>Mo</b>	0.01	0.30
<b>Cu</b>	0.02	0.35
<b>V</b>	0.01	0.80

Note: <sup>a</sup>Single values are maximum.

## All-weld mechanical properties

	Typical	Guaranty
<b>0.2%YS (MPa)</b>	510	400min.
<b>TS (MPa)</b>	570	490~655
<b>EI on 4d (%)</b>	30	22min.
<b>IV -18°C (J)</b>	85	27min.

## Approvals

<b>ABS</b>	2YSA, 2Y400SA, H10
<b>LR</b>	2YS, 2YM, H10
<b>DNV</b>	II YMS, II Y40MS, H10
<b>BV</b>	SA2M, SA2YM, SA2Y40M H10
<b>NK</b>	KSW52Y40G (C) H10
<b>CR</b>	2YS-HH
<b>KR</b>	2YSG (C)
<b>CCS</b>	2SH10, 2YSH10

## Welding parameters (A)

φ mm	1F, 1G, 2F	2G	3G uphill, 4G	3G downhill
1.2	120~300	120~280	120~260	200~300
1.4	160~350	160~320	160~270	220~300
1.6	200~400	200~350	200~280	250~300

## Flux cored wire

- Features:**
- Suitable for welding in all positions including vertical downward
  - Excellent performance especially in vertical upward

**Classification:** AWS A5.20 E71T-1C

**Shielding gas:** CO<sub>2</sub>

**Polarity:** DCEP

## Welding Positions:

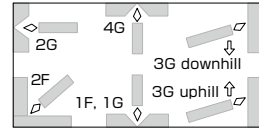

## Packaging data

φ mm	Spool	Drum
1.2	12.5kg, 15kg, 20kg	250kg
1.4	12.5kg, 15kg, 20kg	-
<b>Volume mm</b>	300W, 110H, 300L	530 φ, 820H

## Composition (all-weld metal mass%)

	Typical	Guaranty <sup>a</sup>
<b>C</b>	0.05	0.12
<b>Si</b>	0.55	0.90
<b>Mn</b>	1.28	1.75
<b>P</b>	0.01	0.03
<b>S</b>	0.01	0.03
<b>Ni</b>	0.01	0.50
<b>Cr</b>	0.02	0.20
<b>Mo</b>	0.01	0.30
<b>V</b>	0.02	0.08
<b>Cu</b>	0.02	0.35

Note: <sup>a</sup>Single values are maximum.

## All-weld mechanical properties

	Typical	Guaranty
<b>0.2%YS (MPa)</b>	490	400min.
<b>TS (MPa)</b>	580	490~655
<b>El on 4d (%)</b>	30	22min.
<b>IV -18°C (J)</b>	50	27min.

## Approvals

<b>ABS</b>	2YSA, 2Y400SA, H10
<b>LR</b>	2YS, 2YM, H10
<b>DNV</b>	II YMS
<b>BV</b>	SA2Y40M
<b>NK</b>	KSW52Y40G (C)
<b>CCS</b>	2YS, H10

## Welding parameters (A)

φ mm	1F, 1G, 2F	2G	3G uphill, 4G	3G downhill
1.2	120~300	120~280	120~300	200~300
1.4	160~350	220~320	150~300	220~300

**Flux cored wire**

**Features:** ▪ Excellent impact value at low temperatures down to -29°C

**Classification:** AWS A5.20 E71T-9C

**Shielding gas:** CO<sub>2</sub>

**Polarity:** DCEP

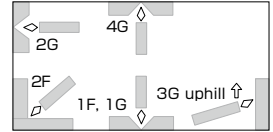
**Welding Positions:****Packaging data**

φ mm	Spool	
	1.2	12.5kg
1.4	-	15kg
<b>Volume mm</b>	300W, 110H, 300L	

**Composition (all-weld metal mass%)**

	Typical	Guaranty <sup>a</sup>
<b>C</b>	0.05	0.12
<b>Si</b>	0.38	0.90
<b>Mn</b>	1.44	1.75
<b>P</b>	0.01	0.03
<b>S</b>	0.01	0.03
<b>Ni</b>	0.38	0.50
<b>Cr</b>	0.03	0.20
<b>Mo</b>	0.01	0.30
<b>V</b>	0.02	0.08
<b>Cu</b>	0.02	0.35

Note: <sup>a</sup> Single values are maximum.

**All-weld mechanical properties**

	Typical	Guaranty
<b>0.2%YS (MPa)</b>	510	400min.
<b>TS (MPa)</b>	570	483~655
<b>EI on 4d (%)</b>	29	22min.
<b>IV -29°C (J)</b>	100	27min.

**Approvals**

<b>ABS</b>	3YSA, 3Y400SA, H10
<b>LR</b>	3YS, H10, 3YM, H10
<b>DNV</b>	III YMS
<b>BV</b>	SA3, 3YM
<b>NK</b>	KSW53G (C)
<b>CR</b>	3YS
<b>CCS</b>	3YS, H10

**Welding parameters (A)**

φ mm	1F, 1G	2F	2G	3G uphill, 4G
1.2	120~300	120~300	120~280	120~250
1.4	150~400	150~350	150~320	150~250

# DW-A50

## Flux cored wire

- Features:**
- Excellent usability with soft and stable arc, less fume and spattering, good bead appearance and smooth slag removal

**Classification:** AWS A5.20 E71T-1M

**Shielding gas:** Ar-CO<sub>2</sub>

**Polarity:** DCEP

### Welding Positions:

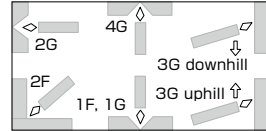

## Packaging data

φ mm	Spool	
	1.2	15kg
1.6	15kg	-
<b>Volume mm</b>	300W, 110H, 300L	

## Composition (all-weld metal mass%)

	Typical	Guaranty <sup>a</sup>
<b>C</b>	0.07	0.12
<b>Si</b>	0.48	0.90
<b>Mn</b>	1.16	1.75
<b>P</b>	0.01	0.03
<b>S</b>	0.01	0.03
<b>Ni</b>	0.01	0.50
<b>Cr</b>	0.02	0.20
<b>Mo</b>	0.01	0.30
<b>V</b>	0.01	0.08
<b>Cu</b>	0.01	0.35

Note: <sup>a</sup> Single values are maximum.

## All-weld mechanical properties

	Typical (AC)	Guaranty
<b>0.2%YS (MPa)</b>	510	400min.
<b>TS (MPa)</b>	570	490~655
<b>El on 4d (%)</b>	30	22min.
<b>IV -18°C (J)</b>	110	27min.

## Approvals

<b>ABS</b>	3YSA, H5
<b>LR</b>	3YS, H5
<b>DNV</b>	III YMS, MG, H5
<b>BV</b>	SA3YM H5
<b>NK</b>	KSW52G (M2), H5

## Welding parameters (A)

φ mm	1F, 1G	2F	2G	3G uphill, 4G	3G downhill
1.2	120~300	120~300	120~280	120~260	200~300
1.6	180~450	180~400	180~350	180~280	250~300

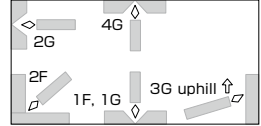
**DW-A51B****Flux cored wire****Features:** ▪ Suitable for butt and fillet welding in all positions**Welding Positions:****Classification:** AWS A5.20 E71T-5M-J**Shielding gas:** Ar-CO<sub>2</sub>**Polarity:** DCEN**Packaging data**

$\phi$ mm	Spool	Drum
1.2	12.5kg, 15kg, 20kg	200kg
<b>Volume mm</b>	300W, 110H, 300L	530 $\phi$ , 820H

**Composition (all-weld metal mass%)**

	Typical	Guaranty <sup>a</sup>
<b>C</b>	0.07	0.12
<b>Si</b>	0.45	0.90
<b>Mn</b>	1.40	1.75
<b>P</b>	0.01	0.03
<b>S</b>	0.01	0.03
<b>Ni</b>	0.02	0.50
<b>Cr</b>	0.03	0.20
<b>Mo</b>	0.02	0.30
<b>V</b>	<0.01	0.08
<b>Cu</b>	0.02	0.35

**Welding parameters (A)**

$\phi$ mm	1F, 1G, 2F, 2G	3G uphill, 4G
1.2	150~300	150~200

Note: <sup>a</sup> Single values are maximum.**All-weld mechanical properties**

	Typical	Guaranty
<b>0.2%YS (MPa)</b>	480	400min.
<b>TS (MPa)</b>	570	483~655
<b>El on 4d (%)</b>	30	22min.
<b>IV -40°C (J)</b>	95	27min.

## Solid wire

**Features:**

- Suitable for butt and fillet welding in all positions
- Suitable for lower currents

**Welding Positions:**

**Classification:** AWS A5.18 ER70S-3

**Shielding gas:** Ar-20%CO<sub>2</sub>

**Polarity:** DCEP

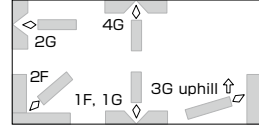

## Packaging data

φ mm	Spool		Drum	
	Weight	Length	Weight	Length
0.9	10kg	20kg	250kg	-
1.0	10kg	20kg	250kg	-
1.2	-	20kg	-	300kg
<b>Volume mm</b>	240W, 110H, 240L	300W, 110H, 300L	530 φ, 820H	

## Composition (wire mass%)

	Typical	Guaranty <sup>a</sup>
<b>C</b>	0.10	0.06~0.15
<b>Si</b>	0.55	0.45~0.75
<b>Mn</b>	1.11	0.90~1.40
<b>P</b>	0.012	0.025
<b>S</b>	0.011	0.035
<b>Cu</b>	0.24	0.50
<b>Ni</b>	0.01	0.15
<b>Cr</b>	0.03	0.15
<b>Mo</b>	<0.01	0.15
<b>V</b>	<0.01	0.03

Note: <sup>a</sup> Single values are maximum.

## All-weld mechanical properties

	Typical	Guaranty
<b>0.2%YS (MPa)</b>	440	400min.
<b>TS (MPa)</b>	540	483min.
<b>EI on 4d (%)</b>	32	22min.
<b>IV -18°C (J)</b>	170	27min.
<b>PWHT</b>	AW	AW

## Approvals

<b>ABS</b>	3YSA
<b>NK</b>	KSW53G (M2)

## Welding parameters (A)

φ mm	1F, 1G, 2F	2G	3G uphill	4G
0.9	50~200	50~180	50~140	50~120
1.0	50~220	50~200	50~140	50~120
1.2	80~350	80~300	50~160	50~140



## Solid wire

- Features:**
- Higher currents can be applied in vertical and overhead positions
  - Suitable for pipe welding in all positions

**Classification:** AWS A5.18 ER70S-6

**Shielding gas:** CO<sub>2</sub>, Ar-20%CO<sub>2</sub>

**Polarity:** DCEP

## Welding Positions:

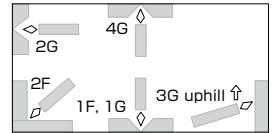

## Packaging data

φ mm	Spool	Drum	
0.9	20kg	-	-
1.0	20kg	250kg	-
1.2	20kg	-	300kg
<b>Volume mm</b>	300W, 110H, 300L	530 φ, 820H	

## Composition (wire mass%)

	Typical (CO <sub>2</sub> )	Guaranty <sup>a</sup>
<b>C</b>	0.10	0.06~0.15
<b>Si</b>	0.88	0.80~1.15
<b>Mn</b>	1.56	1.40~1.85
<b>P</b>	0.011	0.025
<b>S</b>	0.012	0.035
<b>Ni</b>	0.01	0.15
<b>Cr</b>	0.02	0.15
<b>Mo</b>	<0.01	0.15
<b>Cu</b>	0.24	0.50
<b>V</b>	<0.01	0.03

Note: <sup>a</sup> Single values are maximum.

## All-weld mechanical properties

	Typical		Guaranty
<b>0.2%YS (MPa)</b>	470	520	400min.
<b>TS (MPa)</b>	560	600	483min.
<b>EI on 4d (%)</b>	32	31	22min.
<b>IV -29°C (J)</b>	70	90	27min.
<b>SG</b>	CO <sub>2</sub>	Ar-20%CO <sub>2</sub>	CO <sub>2</sub>

## Welding parameters (A)

φ mm	1F, 1G, 2F	2G	3G uphill	4G
0.9	50~200	50~180	50~140	50~120
1.0	50~220	50~200	50~140	50~120
1.2	80~350	80~300	50~160	50~140

## Solid wire

**Features:** • Higher currents are recommended

**Classification:** AWS A5.18 ER70S-G

**Shielding gas:** CO<sub>2</sub>

**Polarity:** DCEP

## Welding Positions:

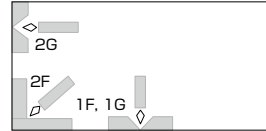

## Packaging data

φ mm	Spool			Drum		
1.0	-	-	20kg	-	-	-
1.2	10kg	15kg	20kg	-	300kg	-
1.4	-	15kg	20kg	250kg	-	400kg
1.6	-	-	20kg	-	-	400kg
<b>Volume mm</b>	240W, 110H, 240L	300W, 110H, 300L		530 φ, 820H	680 φ, 770H	

## Composition (wire mass%)

	Typical	Guaranty <sup>a</sup>
<b>C</b>	0.04	0.02~0.15
<b>Si</b>	0.73	0.55~1.10
<b>Mn</b>	1.58	1.40~1.90
<b>P</b>	0.010	0.030
<b>S</b>	0.010	0.030
<b>Cu</b>	0.23	0.50
<b>Ti+Zr</b>	0.22	0.02~0.30

Note: <sup>a</sup>Single values are maximum.

## Welding parameters (A)

φ mm	1F, 1G, 2F	2G
1.0	50~220	50~200
1.2	100~350	100~300
1.4	150~450	150~350
1.6	200~550	200~400

## All-weld mechanical properties

	Typical		Guaranty
<b>0.2%YS (MPa)</b>	490	420	400min.
<b>TS (MPa)</b>	570	530	483min.
<b>EI on 4d (%)</b>	30	34	22min.
<b>IV -18°C (J)</b>	100	110	0°C: 47min.
<b>PWHT (°C×h)</b>	AW	625x1	AW

## Approvals

	CO <sub>2</sub>	Ar-CO <sub>2</sub>
	<b>ABS</b>	3YSA
<b>LR</b>		3YS, H15
<b>DNV</b>		III YMS
<b>BV</b>	SA3M, SA3YM	SA3YM
<b>NK</b>	KSW53G (C)	KSW53G (M2)
<b>CR</b>	3YS	-
<b>KR</b>	3YSG (C)	-
<b>CCS</b>	3Y	-

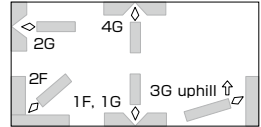
**Solid wire****Features:** ▪ Suitable for butt and fillet welding in all positions**Welding Positions:****Classification:** AWS A5.18 ER70S-G**Shielding gas:** Ar-5~20%CO<sub>2</sub>, Ar-2~5%O<sub>2</sub>**Polarity:** DCEP**Packaging data**

φ mm	Spool		Drum		
	Weight	Length	Weight	Length	Weight
0.8	10kg	-	-	-	-
0.9	10kg	20kg	-	-	-
1.0	10kg	20kg	100kg	-	-
1.2	10kg	20kg	-	250kg	-
1.4	-	20kg	-	-	-
1.6	10kg	20kg	-	-	400kg
<b>Volume mm</b>	240W, 110H, 240L	300W, 110H, 300L	530 φ, 820H		680 φ, 770H

**Composition (wire mass%)**

	Typical (Ar-20%CO <sub>2</sub> )	Guaranty <sup>a</sup>
<b>C</b>	0.10	0.02~0.15
<b>Si</b>	0.75	0.40~1.00
<b>Mn</b>	1.38	0.90~1.60
<b>P</b>	0.011	0.030
<b>S</b>	0.012	0.030
<b>Cu</b>	0.24	0.50

Note: <sup>a</sup> Single values are maximum.**Welding parameters (A)**

φ mm	1F, 1G, 2F	2G	3G uphill	4G
0.8	50~180	50~180	50~140	50~120
0.9	50~200	50~180	50~140	50~120
1.0	50~220	50~200	50~140	50~120
1.2	80~300	80~300	50~160	50~140
1.4	150~400	150~350	-	-
1.6	200~450	200~400	-	-

**All-weld mechanical properties**

	Typical		Typical		Guaranty
	1	2	1	2	
<b>0.2%YS (MPa)</b>	450	370	490	400	400min.
<b>TS (MPa)</b>	570	520	590	540	483min.
<b>EI on 4d (%)</b>	28	32	33	33	22min.
<b>IV -29°C (J)</b>	180	190	180	200	27min.
<b>PWHT (°Cxh)</b>	AW	620x1	AW	620x1	AW
<b>SG</b>	Ar-20%CO <sub>2</sub>		Ar-2%O <sub>2</sub>		Ar-20%CO <sub>2</sub> & Ar-2%O <sub>2</sub>

**Approvals**

<b>ABS</b>	3YSA
<b>LR</b>	3YS
<b>DNV</b>	III YMS

## Solid wire

**Features:**

- Suitable for butt and fillet welding in all positions
- Suitable for higher currents

**Welding Positions:**

**Classification:** AWS A5.18 ER70S-G

**Shielding gas:** Ar-20%CO<sub>2</sub>

**Polarity:** DCEP

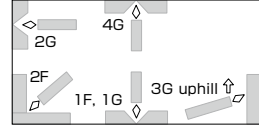
**Packaging data**

φ mm	Spool	Drum		
0.9	20kg	-	-	-
1.0	-	250kg	-	-
1.2	20kg	250kg	300kg	-
1.4	20kg	250kg	-	-
1.6	20kg	-	-	400kg
<b>Volume mm</b>	300W, 110H, 300L	530 φ, 820H		680 φ, 770H

**Composition (wire mass%)**

	Typical	Guaranty <sup>a</sup>
<b>C</b>	0.06	0.02~0.15
<b>Si</b>	0.57	0.40~1.00
<b>Mn</b>	1.17	1.00~1.60
<b>P</b>	0.009	0.030
<b>S</b>	0.011	0.030
<b>Cu</b>	0.24	0.50
<b>Ti+Zr</b>	0.07	0.02~0.15

Note: <sup>a</sup>Single values are maximum.

**All-weld mechanical properties**

	Typical	Guaranty
<b>0.2%YS (MPa)</b>	470	400min.
<b>TS (MPa)</b>	550	483min.
<b>EI on 4d (%)</b>	32	22min.
<b>IV -18°C (J)</b>	170	27min.

**Approvals**

<b>ABS</b>	3YSA
<b>LR</b>	3YS, H15
<b>DNV</b>	III YMS
<b>BV</b>	SA3YM
<b>NK</b>	KSW53G (M2)

**Welding parameters (A)**

φ mm	1F, 1G, 2F	2G	3G uphill	4G
0.9	50~200	50~180	50~140	50~120
1.0	50~220	50~200	50~140	50~120
1.2	80~350	80~300	50~160	50~140
1.4	150~400	150~350	-	-
1.6	200~450	200~400	-	-

**Solid wire**

- Features:**
- Smooth wire feeding, Smooth arc start and stable arc with little spatter generation
  - The special surface treatment that eliminates the need for Cu coating

**Classification:** AWS A5.18 ER70S-G

**Shielding gas:** Ar-20%CO<sub>2</sub>

**Polarity:** DCEP

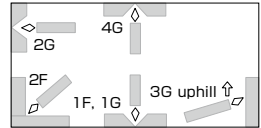
**Welding Positions:****Packaging data**

φ mm	Spool		Drum				
	10kg	20kg		250kg			
0.9	10kg	20kg	-	250kg	-	-	
1.0	10kg	20kg	-	250kg	-	-	
1.2	10kg	20kg	100kg	-	300kg	400kg	
<b>Volume mm</b>	240W, 110H, 240L	300W, 110H, 300L	530 φ, 820H			680 φ, 770H	

**Composition (wire mass%)**

	Typical	Guaranty <sup>a</sup>
<b>C</b>	0.05	0.02~0.15
<b>Si</b>	0.89	0.40~1.00
<b>Mn</b>	1.40	0.90~1.60
<b>P</b>	0.010	0.030
<b>S</b>	0.015	0.030
<b>Cu</b>	0.01	0.50
<b>Ni</b>	0.01	0.15
<b>Cr</b>	0.02	0.15
<b>Mo</b>	<0.01	0.15
<b>V</b>	<0.01	0.03

Note: <sup>a</sup>Single values are maximum.

**Welding parameters (A)**

φ mm	1F, 1G	3G uphill, 4G
0.9	50~220	50~150
1.0	50~250	50~160
1.2	80~300	50~180

**All-weld mechanical properties**

	Typical	Guaranty
<b>0.2%YS (MPa)</b>	460	400min.
<b>TS (MPa)</b>	559	490min.
<b>EI on 4d (%)</b>	30	22min.
<b>IV -20°C (J)</b>	120	27min.

**Approvals**

NK	KSW53G (M2)
----	-------------

## Solid wire

**Features:**

- Suitable for butt and fillet welding in all positions
- Suitable for lower currents

**Welding Positions:**

**Classification:** AWS -

**Shielding gas:** CO<sub>2</sub>

**Polarity:** DCEP

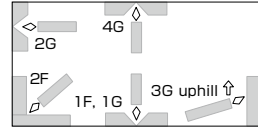
**Packaging data**

φ mm	Spool		Drum	
	0.9	10kg	20kg	250kg
1.0	10kg	20kg	250kg	-
1.2	10kg	20kg	-	300kg
<b>Volume mm</b>	240W, 110H, 240L	300W, 110H, 300L	530 φ, 820H	

**Composition (wire mass%)**

	Typical	Guaranty <sup>a</sup>
<b>C</b>	0.05	0.02~0.15
<b>Si</b>	0.75	0.50~1.00
<b>Mn</b>	1.34	1.25~2.00
<b>P</b>	0.010	0.030
<b>S</b>	0.013	0.030
<b>Cu</b>	0.24	0.50

Note: <sup>a</sup>Single values are maximum.

**Approvals**

	CO <sub>2</sub>	Ar-CO <sub>2</sub>
<b>ABS</b>	3YSA	
<b>LR</b>	3YS, H15	
<b>DNV</b>	III YMS	
<b>BV</b>	SA3M, SA3YM	
<b>NK</b>	KSW53G (C) KWS53Y40G (C)	KSW53G (M2)
<b>CR</b>	3YS	
<b>KR</b>	3YSG (C)	-

**All-weld mechanical properties**

	Typical		Guaranty
<b>0.2%YS (MPa)</b>	460	360	390min.
<b>TS (MPa)</b>	540	490	490~600
<b>EI on 4d (%)</b>	31	34	18min. (5d)
<b>IV -18°C (J)</b>	100	110	0°C: 27min.
<b>PWHT (°C×h)</b>	AW	625x2	AW

**Welding parameters (A)**

φ mm	1F, 1G, 2F	2G	3G uphill	4G
0.9	50~200	50~180	50~140	50~120
1.0	50~220	50~200	50~140	50~120
1.2	80~350	80~300	50~160	50~140

**Solid wire**

**Features:** ▪ Pulsed MAG with MIX-1TS offers better bead appearance on a galvanized steel plate

**Classification:** AWS -

**Shielding gas:** Ar-20%CO<sub>2</sub>

**Polarity:** DCEP (Pulse MAG)

**Packaging data**

φ mm	Spool	Drum
1.2	20kg	300kg
<b>Volume mm</b>	300W, 110H, 300L	680φ, 770H

**Composition (wire mass%)**

	Typical	Guaranty <sup>a</sup>
<b>C</b>	0.05	0.02~0.15
<b>Si</b>	0.77	0.40~1.00
<b>Mn</b>	1.24	0.90~1.60
<b>P</b>	0.011	0.030
<b>S</b>	0.004	0.030
<b>Cu</b>	0.24	0.50

Note: <sup>a</sup>Single values are maximum.

**Welding parameters (A)**

φ mm	Pulse MAG
1.2	100~280

**All-weld mechanical properties**

	Typical	Guaranty
<b>0.2%YS (MPa)</b>	440	390min.
<b>TS (MPa)</b>	540	490~670
<b>El on 4d (%)</b>	30	18min.
<b>IV -20°C (J)</b>	150	27min.

## TIG welding rod and wire

<b>Features:</b>	▪ Suitable for root pass welding of pipes
<b>Classification:</b>	AWS A5.18 ER70S-2
<b>Shielding Gas:</b>	Ar
<b>Identification color:</b>	1st Blue white
<b>Polarity:</b>	DCEN

## Packaging data

Ø mm	Spool		Tube		
	kg		kg	Length mm	g/piece
0.9	10	-	-	-	-
1.0	10	-	-	-	-
1.2	-	-	5	1,000	9
1.6	-	20	5	1,000	16
2.0	-	-	5	1,000	25
2.4	-	-	5	1,000	35
3.2	-	-	5	1,000	63
<b>Volume mm</b>	240W, 110H, 230L	280W, 110H, 270L	40W, 35H, 1015L		

## Composition (wire mass%)

	Typical	Guaranty <sup>a</sup>
<b>C</b>	0.04	0.07
<b>Si</b>	0.54	0.40~0.70
<b>Mn</b>	1.25	0.90~1.40
<b>P</b>	0.007	0.025
<b>S</b>	0.014	0.035
<b>Ni</b>	0.04	0.15
<b>Cr</b>	0.05	0.15
<b>Mo</b>	0.01	0.15
<b>Cu</b>	0.16	0.50
<b>V</b>	<0.01	0.03
<b>Al</b>	0.07	0.05~0.15
<b>Ti</b>	0.08	0.05~0.15
<b>Zr</b>	0.05	0.02~0.12

## All-weld mechanical properties

	Typical		Guaranty
<b>0.2%YS (MPa)</b>	560	520	400min.
<b>TS (MPa)</b>	620	600	483min.
<b>El on 4d (%)</b>	28	30	22min.
<b>IV -29°C (J)</b>	200	160	27min.
<b>PWHT (°C×h)</b>	AW	625x8	AW

Note: <sup>a</sup> Single values are maximum.



**TIG welding rod and wire**

<b>Features:</b>	- Suitable for root pass welding of pipes and general use
<b>Classification:</b>	AWS A5.18 ER70S-2
<b>Shielding Gas:</b>	Ar
<b>Identification color:</b>	-
<b>Polarity:</b>	DCEN

**Packaging data**

φ mm	Tube		
	kg	Length mm	g/piece
2.0	5	1,000	25
2.4	5	1,000	35
<b>Volume mm</b>	430W, 35H, 1015L		

**Composition (wire mass%)**

	Typical	Guaranty <sup>a</sup>
<b>C</b>	0.05	0.07
<b>Si</b>	0.45	0.40~0.70
<b>Mn</b>	1.01	0.90~1.40
<b>P</b>	0.010	0.025
<b>S</b>	0.004	0.035
<b>Ni</b>	0.01	0.15
<b>Cr</b>	0.06	0.15
<b>Mo</b>	0.01	0.15
<b>V</b>	0.01	0.03
<b>Cu</b>	0.13	0.50
<b>Ti</b>	0.09	0.05~0.15
<b>Zr</b>	0.07	0.02~0.12
<b>Al</b>	0.10	0.05~0.15

Note: <sup>a</sup> Single values are maximum.

**All-weld mechanical properties**

	Typical	Guaranty
<b>0.2%YS (MPa)</b>	582	400min.
<b>TS (MPa)</b>	636	483min.
<b>El on 4d (%)</b>	29	22min.
<b>IV -30°C (J)</b>	213	27min.

**TIG welding rod and wire**

<b>Features:</b>	▪ Suitable for root pass welding of pipes and general use
<b>Classification:</b>	AWS A5.18 ER70S-3
<b>Shielding Gas:</b>	Ar
<b>Identification color:</b>	-
<b>Polarity:</b>	DCEN

**Packaging data**

φ mm	Tube		
	kg	Length mm	g/piece
2.0	5	1,000	25
2.4	5	1,000	35
<b>Volume mm</b>	430W, 35H, 1015L		

**Composition (wire mass%)**

	Typical	Guaranty <sup>a</sup>
<b>C</b>	0.10	0.06~0.15
<b>Si</b>	0.56	0.45~0.75
<b>Mn</b>	1.12	0.90~1.40
<b>P</b>	0.008	0.025
<b>S</b>	0.016	0.035
<b>Ni</b>	0.01	0.15
<b>Cr</b>	0.02	0.15
<b>Mo</b>	0.01	0.15
<b>V</b>	0.01	0.03
<b>Cu</b>	0.14	0.50

**All-weld mechanical properties**

	Typical	Guaranty
<b>0.2%YS (MPa)</b>	476	400min.
<b>TS (MPa)</b>	560	483min.
<b>EI on 4d (%)</b>	35	22min.
<b>IV -20°C (J)</b>	240	27min.

Note: <sup>a</sup>Single values are maximum.

**TIG welding rod and wire**

<b>Features:</b>	- Its tensile strength after long time PWHT is high enough for 490MPa
<b>Classification:</b>	AWS A5.18 ER70S-6
<b>Shielding Gas:</b>	Ar
<b>Identification color:</b>	1st Black
<b>Polarity:</b>	DCEN

**Packaging data**

φ mm	Spool		Tube	
	kg	kg	Length mm	g/piece
0.8	10	-	-	-
1.0	10	-	-	-
1.2	10	-	-	-
1.6	-	5	1,000	16
2.0	-	5	1,000	25
2.4	-	5	1,000	35
3.2	-	5	1,000	63
<b>Volume mm</b>	240W, 110H, 230L		40W, 35H, 1015L	

**Composition (wire mass%)**

	Typical	Guaranty <sup>a</sup>
<b>C</b>	0.10	0.06~0.15
<b>Si</b>	0.86	0.80~1.15
<b>Mn</b>	1.56	1.40~1.85
<b>P</b>	0.012	0.025
<b>S</b>	0.012	0.035
<b>Ni</b>	0.01	0.15
<b>Cr</b>	0.02	0.15
<b>Mo</b>	<0.01	0.15
<b>Cu</b>	0.24	0.50
<b>V</b>	<0.01	0.03
<b>Al</b>	<0.01	-
<b>Ti</b>	<0.01	-
<b>Zr</b>	<0.01	-

Note: <sup>a</sup> Single values are maximum.**All-weld mechanical properties**

	Typical		Guaranty
<b>0.2%YS (MPa)</b>	510	420	400min.
<b>TS (MPa)</b>	610	550	483min.
<b>El on 4d (%)</b>	32	35	22min.
<b>IV -29°C (J)</b>	210	160	27min.
<b>PWHT (°C×h)</b>	AW	625x24	AW

**Approvals**

<b>ABS</b>	3Y
<b>LR</b>	3Ym
<b>DNV</b>	III YM

## TIG welding rod and wire

**Features:**

- Good impact value at low temperatures
- Most widely used in Japan

**Classification:** AWS A5.18 ER70S-G

**Shielding Gas:** Ar

**Identification color:** 1st Yellow

**Polarity:** DCEN

## Packaging data

φ mm	Spool		Tube		
	kg		kg	Length mm	g/piece
0.8	10	-	-	-	-
1.0	10	-	-	-	-
1.2	10	20	5	1,000	9
1.6	10	-	5	1,000	16
2.0	-	-	5	1,000	25
2.4	-	-	5	1,000	35
3.2	-	-	5	1,000	63
<b>Volume mm</b>	240W, 110H, 230L	280W, 110H, 270L	40W, 35H, 1015L		

## Composition (wire mass%)

	Typical	Guaranty <sup>a</sup>
<b>C</b>	0.10	0.02~0.12
<b>Si</b>	0.74	0.40~0.95
<b>Mn</b>	1.40	1.00~1.50
<b>P</b>	0.011	0.025
<b>S</b>	0.012	0.025
<b>Cu</b>	0.24	0.50
<b>Al</b>	<0.01	0.15
<b>Ti</b>	<0.01	0.15
<b>Zr</b>	<0.01	0.12

Note: <sup>a</sup> Single values are maximum.

## All-weld mechanical properties

	Typical		Guaranty
<b>0.2%YS (MPa)</b>	480	380	400min.
<b>TS (MPa)</b>	580	500	483min.
<b>EI on 4d (%)</b>	33	36	22min.
<b>IV -29°C (J)</b>	180	230	27min.
<b>PWHT (°C×h)</b>	AW	625x8	AW

## Approvals

<b>ABS</b>	3Y
<b>LR</b>	3Ym, H15
<b>DNV</b>	III YM
<b>BV</b>	SA3YM
<b>NK</b>	KSW53G (I)
<b>CCS</b>	3, 3YSM

## SAW flux and wire combination

<b>Features:</b>	<ul style="list-style-type: none"> <li>• Suitable for fillet welding</li> <li>• Excellent bead appearance and slag removal</li> </ul>
<b>Classification:</b>	AWS A5.17 F7A0-EH14
<b>Type of flux:</b>	Fused
<b>Redrying Conditions:</b>	150~350°Cx1h
<b>Polarity:</b>	AC

## Packaging data

Flux	Mesh	Can					
MF-53	8x48	20kg					
<b>Volume mm</b>		240W, 350H, 240L					
Wire	φ mm	Spool		Coil			Drum
US-36	1.6	10kg	20kg	-	-	-	-
	2.0	10kg	20kg	-	-	-	-
	2.4	10kg	-	25kg	76kg	-	300kg
	3.2	-	-	25kg	76kg	-	300kg
	4.0	-	-	25kg	75kg	150kg	300kg
	4.8	-	-	25kg	75kg	150kg	-
	6.4	-	-	25kg	78kg	159kg	-
<b>Volume mm</b>		240W, 110H, 240L	300W, 110H, 300L	430W, 90H, 430L	740W, 110H, 740L	840W, 110H, 840L	680φ, 770H (2.4φmm) 600φ, 920H (3.2, 4.0φmm)

## Composition (wire mass%)

	Typical	Guaranty <sup>a</sup>
<b>C</b>	0.12	0.10~0.20
<b>Si</b>	0.03	0.10
<b>Mn</b>	1.95	1.70~2.20
<b>P</b>	0.013	0.030
<b>S</b>	0.005	0.030
<b>Cu</b>	0.11	0.35

Note: <sup>a</sup> Single values are maximum.

## Weld mechanical properties

	Typical	Guaranty
<b>0.2%YS (MPa)</b>	430	400min.
<b>TS (MPa)</b>	510	483~655
<b>EI on 4d (%)</b>	29	22min.
<b>IV -18°C (J)</b>	40	27min.

## Composition (weld metal mass%)

	Typical
<b>C</b>	0.05
<b>Si</b>	0.67
<b>Mn</b>	1.61
<b>P</b>	0.016
<b>S</b>	0.009

**SAW flux and wire combination**

**Features:**

- Suitable for welding of thin plates at high speeds
- DCEP is better for sheet metal of 4mm or thinner

**Classification:** AWS A5.17 F7A2-EH14

**Type of flux:** Fused

**Redrying of flux:** 150~350°Cx1h

**Polarity:** AC

**Packaging data**

Flux	Mesh	Can					
G-50	8x48	25kg					
<b>Volume mm</b>		240W, 350H, 240L					
Wire	φ mm	Spool		Coil			Drum
US-36	1.6	10kg	20kg	-	-	-	-
	2.0	10kg	20kg	-	-	-	-
	2.4	10kg	-	25kg	76kg	-	300kg
	3.2	-	-	25kg	76kg	-	300kg
	4.0	-	-	25kg	75kg	150kg	300kg
	4.8	-	-	25kg	75kg	150kg	-
6.4	-	-	25kg	78kg	159kg	-	
<b>Volume mm</b>		240W, 110H, 240L	300W, 110H, 300L	430W, 90H, 430L	740W, 110H, 740L	840W, 110H, 840L	680φ, 770H (2.4φmm) 600φ, 920H (3.2, 4.0φmm)

**Composition (wire mass%)**

	Typical	Guaranty <sup>a</sup>
<b>C</b>	0.12	0.10~0.20
<b>Si</b>	0.03	0.10
<b>Mn</b>	1.95	1.70~2.20
<b>P</b>	0.013	0.030
<b>S</b>	0.005	0.030
<b>Cu</b>	0.11	0.35

Note: <sup>a</sup> Single values are maximum.

**All-weld mechanical properties**

	Typical	Guaranty
<b>0.2%YS (MPa)</b>	440	400min.
<b>TS (MPa)</b>	540	483~655
<b>El on 4d (%)</b>	29	22min.
<b>IV -29°C (J)</b>	40	27min.

**Composition (weld metal mass%)**

	Typical
<b>C</b>	0.06
<b>Si</b>	0.44
<b>Mn</b>	1.83
<b>P</b>	0.012
<b>S</b>	0.004

**SAW flux and wire combination****Features:** ▪ Suitable for welding of thin or medium plate at high speeds**Classification:** AWS A5.17 F7A2-EH14**Type of flux:** Fused**Redrying of flux:** 150~350°Cx1h**Polarity:** AC**Packaging data**

Flux	Mesh	Can					
G-60	12x65	25kg					
	12x150	25kg					
<b>Volume mm</b>		240W, 350H, 240L					
Wire	φ mm	Spool		Coil			Drum
US-36	1.6	10kg	20kg	-	-	-	-
	2.0	10kg	20kg	-	-	-	-
	2.4	10kg	-	25kg	76kg	-	300kg
	3.2	-	-	25kg	76kg	-	300kg
	4.0	-	-	25kg	75kg	150kg	300kg
	4.8	-	-	25kg	75kg	150kg	-
	6.4	-	-	25kg	78kg	159kg	-
<b>Volume mm</b>		240W, 110H, 240L	300W, 110H, 300L	430W, 90H, 430L	740W, 110H, 740L	840W, 110H, 840L	680φ, 770H (2.4φmm) 600φ, 920H (3.2, 4.0φmm)

**Composition (wire mass%)**

	Typical	Guaranty <sup>a</sup>
<b>C</b>	0.12	0.10~0.20
<b>Si</b>	0.03	0.10
<b>Mn</b>	1.95	1.70~2.20
<b>P</b>	0.013	0.030
<b>S</b>	0.005	0.030
<b>Cu</b>	0.11	0.35

Note: <sup>a</sup> Single values are maximum.**All-weld mechanical properties**

	Typical	Guaranty
<b>0.2%YS (MPa)</b>	460	400min.
<b>TS (MPa)</b>	560	483~655
<b>EI on 4d (%)</b>	27	22min.
<b>IV -29°C (J)</b>	40	27min.

**Composition (weld metal mass%)**

	Typical
<b>C</b>	0.07
<b>Si</b>	0.34
<b>Mn</b>	1.70
<b>P</b>	0.017
<b>S</b>	0.004

**SAW flux and wire combination**

**Features:**

- Suitable for welding of medium or heavy thick plate
- Good Mechanical properties in multi-pass welding

**Classification:** AWS A5.17 F7A2-EH14, F6P2-EH14

**Type of flux:** Fused

**Redrying Conditions:** 150~350°Cx1h

**Polarity:** AC

**Packaging data**

Flux	Mesh	Can
<b>G-80</b>	12x65	25kg
	12x200	25kg
	20x200	25kg
	32x200	25kg
	20xD	25kg

**Volume mm** 240W, 350H, 240L

Wire	φ mm	Spool		Coil			Drum
<b>US-36</b>	1.6	10kg	20kg	-	-	-	-
	2.0	10kg	20kg	-	-	-	-
	2.4	10kg	-	25kg	76kg	-	300kg
	3.2	-	-	25kg	76kg	-	300kg
	4.0	-	-	25kg	75kg	150kg	300kg
	4.8	-	-	25kg	75kg	150kg	-
	6.4	-	-	25kg	78kg	159kg	-

**Volume mm** 240W, 110H, 240L 300W, 110H, 300L 430W, 90H, 430L 740W, 110H, 740L 840W, 110H, 840L 680φ, 770H (2.4φmm)  
600φ, 920H (3.2, 4.0φmm)

**Composition (wire mass%)**

	Typical	Guaranty <sup>a</sup>
<b>C</b>	0.12	0.10~0.20
<b>Si</b>	0.03	0.10
<b>Mn</b>	1.95	1.70~2.20
<b>P</b>	0.013	0.030
<b>S</b>	0.005	0.030
<b>Cu</b>	0.11	0.35

Note: <sup>a</sup> Single values are maximum.

**Weld mechanical properties**

	Typical		Guaranty	
<b>0.2%YS (MPa)</b>	410	360	400min.	330min.
<b>TS (MPa)</b>	520	500	483~655	410~550
<b>EI on 4d (%)</b>	29	35	22min.	22min.
<b>IV -29°C (J)</b>	43	82	27min.	27min.
<b>PWHT (°C/h)</b>	AW	620x1	AW	620±15x1

**Composition (weld metal mass%)**

	Typical
<b>C</b>	0.09
<b>Si</b>	0.46
<b>Mn</b>	1.41
<b>P</b>	0.018
<b>S</b>	0.011



## SAW flux and wire combination

**Features:**                      • Suitable for single-pass-on-both-sides or multi-layer butt welding  
    • Good bead appearance and excellent impact value

**Classification:**            AWS A5.17 F7A4-EH14

**Type of flux:**                Bonded

**Redrying Conditions:** 200~300°Cx1h

**Polarity:**                      AC

## Packaging data

Flux	Mesh	Can					
PF-H55E	10x48	20kg					
<b>Volume mm</b>		240W, 350H, 240L					
Wire	φ mm	Spool		Coil			Drum
US-36	1.6	10kg	20kg	-	-	-	-
	2.0	10kg	20kg	-	-	-	-
	2.4	10kg	-	25kg	76kg	-	300kg
	3.2	-	-	25kg	76kg	-	300kg
	4.0	-	-	25kg	75kg	150kg	300kg
	4.8	-	-	25kg	75kg	150kg	-
	6.4	-	-	25kg	78kg	159kg	-
<b>Volume mm</b>		240W, 110H, 240L	300W, 110H, 300L	430W, 90H, 430L	740W, 110H, 740L	840W, 110H, 840L	680φ, 770H (2.4φmm) 600φ, 920H (3.2, 4.0φmm)

## Composition (wire mass%)

	Typical	Guaranty <sup>a</sup>
<b>C</b>	0.12	0.10~0.20
<b>Si</b>	0.03	0.10
<b>Mn</b>	1.95	1.70~2.20
<b>P</b>	0.013	0.030
<b>S</b>	0.005	0.030
<b>Cu</b>	0.11	0.35

Note: <sup>a</sup> Single values are maximum.

## Weld mechanical properties

	Typical	Guaranty
<b>0.2%YS (MPa)</b>	460	400min.
<b>TS (MPa)</b>	530	483~655
<b>EI on 4d (%)</b>	32	22min.
<b>IV -40°C (J)</b>	118	27min.

## Approvals

	Single	Tandem
<b>ABS</b>	3TM, 3YTM, 3Y400TM	3YTM, 3Y400TM
<b>LR</b>	3T, 3YM, 3YT	
<b>DNV</b>	III YTM	
<b>BV</b>	A3YTM	A3, A3YT
<b>NK</b>	KAW53Y40TM	KAW53Y40M
<b>CR</b>	3M, 3YTM	-

## Composition (weld metal mass%)

	Typical
<b>C</b>	0.09
<b>Si</b>	0.21
<b>Mn</b>	1.23
<b>P</b>	0.015
<b>S</b>	0.007

## SAW flux and wire combination

**Features:**

- Suitable for welding of medium or heavy thick plate
- Excellent mechanical properties

**Classification:** AWS A5.17 F7A6-EH14, F7P6-EH14

**Type of flux:** Fused

**Redrying of flux:** 150~350°Cx1h

**Polarity:** AC

## Packaging data

Flux	Mesh	Can					
MF-38	12x65	25kg					
	20x200	25kg					
	20xD	25kg					
<b>Volume mm</b>		240W, 350H, 240L					
Wire	φ mm	Spool		Coil			Drum
US-36	1.6	10kg	20kg	-	-	-	-
	2.0	10kg	20kg	-	-	-	-
	2.4	10kg	-	25kg	76kg	-	300kg
	3.2	-	-	25kg	76kg	-	300kg
	4.0	-	-	25kg	75kg	150kg	300kg
	4.8	-	-	25kg	75kg	150kg	-
	6.4	-	-	25kg	78kg	159kg	-
<b>Volume mm</b>		240W, 110H, 240L	300W, 110H, 300L	430W, 90H, 430L	740W, 110H, 740L	840W, 110H, 840L	680φ, 770H (2.4φmm) 600φ, 920H (3.2, 4.0φmm)

## Composition (wire mass%)

	Typical	Guaranty <sup>a</sup>
<b>C</b>	0.12	0.10~0.20
<b>Si</b>	0.03	0.10
<b>Mn</b>	1.95	1.70~2.20
<b>P</b>	0.013	0.030
<b>S</b>	0.005	0.030
<b>Cu</b>	0.11	0.35

Note: <sup>a</sup>Single values are maximum.

## Weld mechanical properties

	Typical		Guaranty	
<b>0.2%YS (MPa)</b>	490	420	400min.	400min.
<b>TS (MPa)</b>	570	530	483~655	483~655
<b>EI on 4d (%)</b>	30	31	22min.	22min.
<b>IV -51°C (J)</b>	59	64	27min.	27min.
<b>PWHT (°Cxh)</b>	AW	620x1	AW	620±15x1

## Composition (weld metal mass%)

	Typical
<b>C</b>	0.09
<b>Si</b>	0.32
<b>Mn</b>	1.63
<b>P</b>	0.018
<b>S</b>	0.011

**SAW flux and wire combination**

**Features:**

- Suitable for welding of medium or heavy thick plate
- Excellent slag removal and good mechanical properties

**Classification:** AWS A5.17 F7A6-EH14, F7P6-EH14

**Type of flux:** Fused

**Redrying of flux:** 150~350°Cx1h

**Polarity:** AC

**Packaging data**

Flux	Mesh	Can					
<b>MF-300</b>	20x200	25kg					
	20xD	25kg					
<b>Volume mm</b>		240W, 350H, 240L					
Wire	φ mm	Spool		Coil			Drum
<b>US-36</b>	1.6	10kg	20kg	-	-	-	-
	2.0	10kg	20kg	-	-	-	-
	2.4	10kg	-	25kg	76kg	-	300kg
	3.2	-	-	25kg	76kg	-	300kg
	4.0	-	-	25kg	75kg	150kg	300kg
	4.8	-	-	25kg	75kg	150kg	-
	6.4	-	-	25kg	78kg	159kg	-
<b>Volume mm</b>		240W, 110H, 240L	300W, 110H, 300L	430W, 90H, 430L	740W, 110H, 740L	840W, 110H, 840L	680φ, 770H (2.4φmm) 600φ, 920H (3.2, 4.0φmm)

**Composition (wire mass%)**

	Typical	Guaranty <sup>a</sup>
<b>C</b>	0.12	0.10~0.20
<b>Si</b>	0.03	0.10
<b>Mn</b>	1.95	1.70~2.20
<b>P</b>	0.013	0.030
<b>S</b>	0.005	0.030
<b>Cu</b>	0.11	0.35

Note: <sup>a</sup> Single values are maximum.

**Weld mechanical properties**

	Typical		Guaranty	
<b>0.2%YS (MPa)</b>	470	410	400min.	400min.
<b>TS (MPa)</b>	570	520	483~655	483~655
<b>El on 4d (%)</b>	30	31	22min.	22min.
<b>IV -51°C (J)</b>	90	82	27min.	27min.
<b>PWHT (°Cxh)</b>	AW	620x1	AW	620±15x1

**Composition (weld metal mass%)**

	Typical
<b>C</b>	0.09
<b>Si</b>	0.23
<b>Mn</b>	1.62
<b>P</b>	0.014
<b>S</b>	0.007

**Approvals**

<b>NK</b>	<b>KAW52T</b>
-----------	---------------

## SAW flux and wire combination

**Features:**

- Suitable for single-pass-on-both-sides or multi-layer butt welding & fillet welding
- Good bead appearance and impact value

**Classification:** AWS A5.17 F7A2-EM12K, F6P4-EM12K  
ISO 14174 S A AB 1

**Type of flux:** Sintered

**Redrying of flux:** 200~300°Cx1h

**Polarity:** DCEP

## Packaging data

Flux	Mesh	Bag			
AF-490E	12x65	20kg			
Volume mm		500W, 50H, 700L			
Wire	φ mm	Spool		Coil	
US-29	1.6	10kg	20kg	-	-
	2.0	10kg	20kg	25kg	-
	2.4	10kg	20kg	25kg	-
	3.2	-	-	25kg	-
	4.0	-	-	25kg	75kg
	4.8	-	-	25kg	75kg
Volume mm		240W, 110H, 240L	300W, 110H, 300L	430W, 90H, 430L	740W, 110H, 740L

## Composition (wire mass%)

	Typical	Guaranty <sup>a</sup>
C	0.09	0.05~0.15
Si	0.22	0.10~0.35
Mn	1.04	0.80~1.25
P	0.012	0.030
S	0.006	0.030
Cu	0.11	0.35

Note: <sup>a</sup>Single values are maximum.

## Weld mechanical properties

	Typical		Guaranty	
<b>0.2%YS (MPa)</b>	410	350	400min.	330min.
<b>TS (MPa)</b>	500	460	483~655	410~550
<b>El on 4d (%)</b>	34	36	22min.	22min.
<b>IV X °C (J)</b>	-29°C:140	-40°C:150	27min.	27min.
<b>PWHT (°C×h)</b>	AW	620x1	AW	620±15x1

## Composition (weld metal mass%)

	Typical
C	0.04
Si	0.29
Mn	1.28
P	0.024
S	0.005

## Approvals

<b>ABS</b>	3Y
<b>LR</b>	3T, 3YM, 3YT
<b>DNV</b>	III YTM
<b>BV</b>	3TM, 3YTM

Note: Single electrode

## SAW flux and wire combination

- Features:**
- Suitable for single-pass-on-both-sides or multi-layer butt welding & spiral welding
  - Good bead appearance and slag removability
  - Excellent impact value

**Classification:** AWS A5.17 F7A4-EH14, F7P4-EH14  
ISO 14174 S A AR 1

**Type of flux:** Sintered

**Redrying of flux:** 200~300°Cx1h

**Polarity:** DCEP

## Packaging data

Flux	Mesh	Bag					
AF-490SP	12x65	20kg					
Volume mm		500W, 50H, 700L					
Wire	φ mm	Spool		Coil			Drum
US-36	1.6	10kg	20kg	-	-	-	-
	2.0	10kg	20kg	-	-	-	-
	2.4	10kg	-	25kg	76kg	-	300kg
	3.2	-	-	25kg	76kg	-	300kg
	4.0	-	-	25kg	75kg	150kg	300kg
	4.8	-	-	25kg	75kg	150kg	-
	6.4	-	-	25kg	78kg	159kg	-
Volume mm		240W, 110H, 240L	300W, 110H, 300L	430W, 90H, 430L	740W, 110H, 740L	840W, 110H, 840L	660φ, 770H (2.4φ) 600φ, 920H (3.2, 4.0φ)

## Composition (wire mass%)

	Typical	Guaranty <sup>a</sup>
C	0.12	0.10~0.20
Si	0.03	0.10
Mn	1.95	1.70~2.20
P	0.013	0.030
S	0.005	0.030
Cu	0.11	0.35

Note: <sup>a</sup> Single values are maximum.

## Weld mechanical properties

	Typical		Guaranty	
0.2%YS (MPa)	500	480	400min.	400min.
TS (MPa)	570	570	483~655	483~655
El on 4d (%)	30	35	22min.	22min.
IV -40°C (J)	150	110	27min.	27min.
PWHT (°Cxh)	AW	620x1	AW	620±15x1

## Composition (weld metal mass%)

	Typical
C	0.05
Si	0.35
Mn	1.19
P	0.022
S	0.004

# AF-490AS/US-36

**FAMILIARC™****SAW flux and wire combination**

**Features:**

- Suitable for multi-layer butt welding
- Good bead appearance and excellent impact value

**Classification:** AWS A5.17 F7A6-EH14, F7P6-EH14  
ISO 14174 S A FB 1

**Type of flux:** Sintered

**Redrying of flux:** 200~300°Cx1h

**Polarity:** DCEP

**Packaging data**

Flux	Mesh	Bag					
AF-490AS	12x65	20kg					
Volume mm		500W, 50H, 700L					
Wire	φ mm	Spool		Coil			Drum
US-36	1.6	10kg	20kg	-	-	-	-
	2.0	10kg	20kg	-	-	-	-
	2.4	10kg	-	25kg	76kg	-	300kg
	3.2	-	-	25kg	76kg	-	300kg
	4.0	-	-	25kg	75kg	150kg	300kg
	4.8	-	-	25kg	75kg	150kg	-
6.4	-	-	25kg	78kg	159kg	-	
Volume mm		240W, 110H, 240L	300W, 110H, 300L	430W, 90H, 430L	740W, 110H, 740L	840W, 110H, 840L	680φ, 770H (2.4φ) 600φ, 920H (3.2, 4.0φ)

**Composition (wire mass%)**

	Typical	Guaranty <sup>a</sup>
C	0.12	0.10~0.20
Si	0.03	0.10
Mn	1.95	1.70~2.20
P	0.013	0.030
S	0.005	0.030
Cu	0.11	0.35

Note: <sup>a</sup>Single values are maximum.

**Weld mechanical properties**

	Typical		Guaranty	
<b>0.2%YS (MPa)</b>	460	410	400min.	400min.
<b>TS (MPa)</b>	550	512	483~655	483~655
<b>EI on 4d (%)</b>	32	36	22min.	22min.
<b>IV -51°C (J)</b>	200	170	27min.	27min.
<b>PWHT (°C×h)</b>	AW	620x1	AW	620±15x1

**Composition (weld metal mass%)**

	Typical
C	0.06
Si	0.18
Mn	1.55
P	0.021
S	0.004

**Approvals**

<b>ABS</b>	4Y
<b>LR</b>	4YM
<b>DNV</b>	IVYM
<b>BV</b>	4YM

Note: Single electrode

# **For Weather Proof Steel**

## **Welding Consumables for**

---

**SMAW**

**FCAW**

**GMAW**

**SAW**

# SMAW, FCAW, GMAW, SAW

## A guide for selecting welding consumables

Table 1 shows suitable welding consumables for shielded metal arc welding (SMAW), flux cored arc welding (FCAW), gas metal arc welding (GMAW), and submerged arc welding (SAW) of weather proof steels.

Table 1 Welding consumables for weather proof steel

	ASTM	ASTM
Steel grade	A709 Gr.36	A588 A709 Gr.50W A242
SMAW	<b>LB-W52B</b>	<b>LB-W588</b> <b>LB-W62G</b>
FCAW	<b>DW-50W</b>	<b>DW-588</b>
GMAW	<b>MG-W50TB</b>	-
SAW	<b>MF-38/US-W52B</b> <b>MF-53/US-W52B (2F)</b>	-

Note: 2F designate suitable welding position.



## Tips for better welding results

In addition to the tips for mild steel and 490MPa high tensile strength steel, the following notes should be taken into consideration in welding weather proof steels.

- (1) Remove rust and dirt from welding grooves to prevent pits and blowholes in the weld metal.
- (2) Use an appropriate welding procedure taking into account the requirements for the mechanical properties of the weldment, because heat input, interpass temperature and plate thickness affect the cooling rate of welds and, where the cooling rate is excessively low, the tensile strength and notch toughness of the weld decrease.
- (3) Use appropriate preheating according to the type of base metal and the thickness of the work to prevent cold cracking in the weld. Table 2 shows the minimum preheat temperatures used in general applications.

Table 2 Minimum preheat temperatures (°C) for general uses

Steel grade (See Table 1)	Welding process	Plate thickness (mm)		
		25 max	Over 25 Up to 38	Over 38 Up to 50
A709 Gr.36	SMAW	-	50	100
	FCAW, GMAW, SAW	-	-	50
A588 A709 Gr.50W A242	SMAW	50	100	100
	FCAW, GMAW, SAW	-	-	50

- (4) For welding a high-phosphorous weather proof steel (e.g., A242), use lower welding currents and slower welding speeds to prevent hot cracking.

## Stick electrode

**Features:** ▪ Suitable for weather proof steel

**Classification:** AWS A5.5 E7016-G

**Redrying Conditions:** 300~350°Cx0.5~1h

**Identification color:** 1st Blue, 2nd Pink

**Polarity:** AC, DCEP

## Welding Positions:

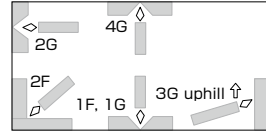

## Packaging data

φ mm	Length mm	kg/pack	kg/carton	g/piece	carton mm
3.2	350	5	20	30	170W, 110H, 380L
4.0	400	5	20	55	170W, 105H, 430L
5.0	450	5	20	95	170W, 110H, 480L

## Composition (all-weld metal mass%)

	Typical (AC)	Guaranty <sup>a</sup>
<b>C</b>	0.06	0.12
<b>Si</b>	0.53	0.90
<b>Mn</b>	0.86	0.30~1.40
<b>P</b>	0.01	0.03
<b>S</b>	<0.01	0.03
<b>Ni</b>	0.30	0.25~0.70
<b>Cr</b>	0.04	0.30
<b>Cu</b>	0.33	0.20~0.60

Note: <sup>a</sup>Single values are maximum.

## Welding parameters (A)

φ mm	1F, 1G, 2F, 2G	3G uphill, 4G
3.2	80~130	80~115
4.0	130~180	110~170
5.0	180~240	150~210

## All-weld mechanical properties

	Typical (AC)	Guaranty
<b>0.2%YS (MPa)</b>	490	393min.
<b>TS (MPa)</b>	550	483min.
<b>EI on 4d (%)</b>	31	22min.
<b>IV -29°C (J)</b>	130	-

## Stick electrode

**Features:** • Suitable for weather proof steel

**Classification:** AWS A5.5 E7016-G

**Redrying Conditions:** 350~400°Cx1h

**Identification color:** 1st Green, 2nd Red

**Polarity:** AC, DCEP

## Welding Positions:

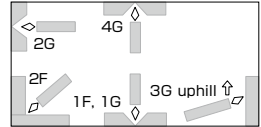

## Packaging data

$\phi$ mm	Length mm	kg/pack	kg/carton	g/piece	carton mm
3.2	350	5	20	32	170W, 110H, 380L
4.0	400	5	20	55	170W, 105H, 430L
5.0	450	5	20	96	170W, 110H 480L

## Composition (all-weld metal mass%)

	Typical (AC)	Guaranty <sup>a</sup>
<b>C</b>	0.06	0.12
<b>Si</b>	0.59	0.90
<b>Mn</b>	0.65	0.30~1.40
<b>P</b>	0.01	0.03
<b>S</b>	<0.01	0.03
<b>Ni</b>	0.22	0.05~0.45
<b>Cr</b>	0.61	0.45~0.75
<b>Cu</b>	0.32	0.30~0.70

## Welding parameters (A)

$\phi$ mm	1F, 1G, 2F, 2G	3G uphill, 4G
3.2	90~130	80~120
4.0	130~180	110~170
5.0	180~240	150~210

Note: <sup>a</sup> Single values are maximum.

## All-weld mechanical properties

	Typical (AC)	Guaranty
<b>0.2%YS (MPa)</b>	480	393min.
<b>TS (MPa)</b>	570	483min.
<b>El on 4d (%)</b>	29	22min.
<b>IV -29°C (J)</b>	140	-

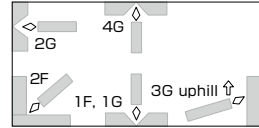
**Flux cored wire****Features:** - Applicable for A588 steel**Classification:** AWS A5.29 E81T1-W2C**Shielding gas:** CO<sub>2</sub>**Polarity:** DCEP**Welding Positions:****Packaging data**

$\phi$ mm	Spool		
1.2	12.5kg	15kg	20kg
Volume mm	300W, 110H, 300L		

**Composition (all-weld metal mass%)**

	Typical	Guaranty <sup>a</sup>
<b>C</b>	0.03	0.12
<b>Si</b>	0.62	0.35~0.80
<b>Mn</b>	1.23	0.50~1.30
<b>P</b>	0.010	0.030
<b>S</b>	0.010	0.030
<b>Ni</b>	0.45	0.40~0.80
<b>Cr</b>	0.49	0.45~0.70
<b>Cu</b>	0.34	0.30~0.75

Note: <sup>a</sup> Single values are maximum.**Welding parameters (A)**

$\phi$ mm	1F, 1G, 2F, 2G	3G uphill, 4G
1.2	120~280	120~260

**All-weld mechanical properties**

	Typical	Guaranty
<b>0.2%YS (MPa)</b>	550	469min.
<b>TS (MPa)</b>	620	552~689
<b>EI on 4d (%)</b>	27	19min.
<b>IV -29°C (J)</b>	60	27min.

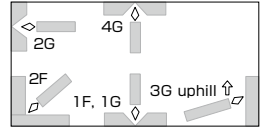
**Flux cored wire****Features:** ▪ Applicable for weather proof steel**Classification:** AWS -**Shielding gas:** CO<sub>2</sub>**Polarity:** DCEP**Welding Positions:****Packaging data**

φ mm	Spool			Drum
	1.2	12.5kg	15kg	
<b>Volume mm</b>	300W, 110H, 300L			530 φ, 820H

**Composition (all-weld metal mass%)**

	Typical	Guaranty <sup>a</sup>
<b>C</b>	0.04	0.12
<b>Si</b>	0.49	0.90
<b>Mn</b>	1.12	0.50~1.60
<b>P</b>	0.010	0.030
<b>S</b>	0.008	0.030
<b>Ni</b>	0.33	0.10~0.45
<b>Cr</b>	0.48	0.45~0.75
<b>Cu</b>	0.39	0.30~0.75

**Welding parameters (A)**

φ mm	1F, 1G, 2F, 2G	3G uphill, 4G
1.2	120~280	120~260

Note: <sup>a</sup> Single values are maximum.**All-weld mechanical properties**

	Typical	Guaranty
<b>0.2%YS (MPa)</b>	510	400min.
<b>TS (MPa)</b>	590	490~670
<b>EI on 4d (%)</b>	27	20min.
<b>IV 0°C (J)</b>	140	47min.

## Solid wire

**Features:**

- Applicable for weatherproof steel
- Lower currents are suitable

**Classification:** AWS A5.28 ER80S-G

**Shielding gas:** CO<sub>2</sub>, Ar-20%CO<sub>2</sub>

**Polarity:** DCEP

## Welding Positions:

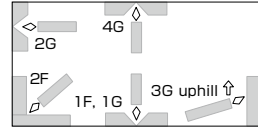

## Packaging data

φ mm	Spool	
0.9	-	20kg
1.0	10kg	-
1.2	10kg	20kg
<b>Volume mm</b>	240W, 110H, 240L	300W, 110H, 300L

## Composition (wire mass%)

	Typical	Guaranty <sup>a</sup>
<b>C</b>	0.03	0.12
<b>Si</b>	0.77	0.50~0.90
<b>Mn</b>	1.35	1.00~1.80
<b>P</b>	0.008	0.030
<b>S</b>	0.013	0.030
<b>Ni</b>	0.18	0.10~0.80
<b>Cr</b>	0.61	0.50~0.80
<b>Cu</b>	0.45	0.30~0.60

## Welding parameters (A)

φ mm	1F, 1G, 2F	2G	3G uphill, 4G
0.9	50~200	50~180	50~120
1.0	50~220	50~200	50~120
1.2	80~320	80~300	50~140

Note: <sup>a</sup>Single values are maximum.

## All-weld mechanical properties

	Typical		Guaranty	
<b>0.2%YS (MPa)</b>	450	480	400min.	400min.
<b>TS (MPa)</b>	560	580	552min.	552min.
<b>EI on 4d (%)</b>	30	29	19min.	19min.
<b>IV (J)</b>	0°C: 110	-18°C: 120	0°C: 47min.	-18°C: 47min.
<b>SG</b>	CO <sub>2</sub>	Ar-20%CO <sub>2</sub>	CO <sub>2</sub>	Ar-20%CO <sub>2</sub>

**MF-53/US-W52B****Flux and wire combination**

**Features:**

- Suitable for fillet welding
- Excellent bead appearance and good slag removal

**Classification:** AWS A5.23 F7A0-EG-G

**Redrying Conditions:** 150~350°Cx1h

**Polarity:** AC

**Packaging data**

Flux	Mesh	Can			
MF-53	8x48	20kg			
Volume mm		240W, 350H, 240L			
Wire	φ mm	Spool		Coil	
US-W52B	1.6	10kg	20kg	-	-
	2.0	10kg	20kg	-	-
	2.4	10kg	-	-	-
	3.2	-	-	25kg	76kg
	4.0	-	-	25kg	75kg
	4.8	-	-	25kg	-
Volume mm		240W, 110H, 240L	300W, 110H, 300L	430W, 90H, 430L	740W, 110H, 740L

**Composition (wire mass%)**

	Typical	Guaranty <sup>a</sup>
<b>C</b>	0.10	0.15
<b>Si</b>	0.03	0.10
<b>Mn</b>	1.51	1.20~1.80
<b>P</b>	0.010	0.025
<b>S</b>	0.004	0.025
<b>Ni</b>	0.14	0.10~0.25
<b>Cr</b>	0.62	0.50~0.80
<b>Cu</b>	0.36	0.30~0.55

**Composition (weld metal mass%)**

	Typical
<b>C</b>	0.05
<b>Si</b>	0.58
<b>Mn</b>	1.35
<b>P</b>	0.009
<b>S</b>	0.007
<b>Ni</b>	0.18
<b>Cr</b>	0.59
<b>Cu</b>	0.36

Note: <sup>a</sup> Single values are maximum.

**All-weld mechanical properties**

	Typical	Guaranty
<b>0.2%YS (MPa)</b>	430	400min.
<b>TS (MPa)</b>	530	483~655
<b>El on 4d (%)</b>	23	22min.
<b>IV -18°C (J)</b>	35	27min.

**MF-38/US-W52B****FAMILIARC™****Flux and wire combination**

**Features:**

- Suitable for butt and flat fillet welding
- Good impact value

**Classification:** AWS A5.23 F7A2-EG-G

**Redrying Conditions:** 150~350°Cx1h

**Polarity:** AC

**Packaging data**

Flux	Mesh	Can			
MF-38	12x65	25kg			
	20x200	25kg			
	20xD	25kg			
<b>Volume mm</b>		240W, 350H, 240L			
Wire	φ mm	Spool		Coil	
US-W52B	1.6	10kg	20kg	-	-
	2.0	10kg	20kg	-	-
	2.4	10kg	-	25kg	-
	3.2	-	-	25kg	76kg
	4.0	-	-	25kg	75kg
	4.8	-	-	25kg	-
<b>Volume mm</b>		240W, 110H, 240L	300W, 110H, 300L	430W, 90H, 430L	740W, 110H, 740L

**Composition (wire mass%)**

	Typical	Guaranty <sup>a</sup>
<b>C</b>	0.10	0.15
<b>Si</b>	0.03	0.10
<b>Mn</b>	1.51	1.20~1.80
<b>P</b>	0.010	0.025
<b>S</b>	0.004	0.025
<b>Ni</b>	0.14	0.10~0.25
<b>Cr</b>	0.62	0.50~0.80
<b>Cu</b>	0.36	0.30~0.55

**Composition (weld metal mass%)**

	Typical
<b>C</b>	0.05
<b>Si</b>	0.32
<b>Mn</b>	1.48
<b>P</b>	0.017
<b>S</b>	0.005
<b>Ni</b>	0.14
<b>Cr</b>	0.51
<b>Cu</b>	0.35

Note: <sup>a</sup>Single values are maximum.

**All-weld mechanical properties**

	Typical	Guaranty
<b>0.2%YS (MPa)</b>	490	400min.
<b>TS (MPa)</b>	590	483~655
<b>EI on 4d (%)</b>	25	22min.
<b>IV -29°C (J)</b>	76	27min.



# **For High Tensile Strength Steel and Low Temperature Steel**

## **Welding Consumables for**

**SMAW**

**FCAW**

**GMAW**

**GTAW**

**SAW**

# SMAW, FCAW, GMAW, GTAW, SAW

## A guide for selecting welding consumables

TS (MPa) min.	490	520	550
YS (MPa) min.	350	400	420
IV (J) min.	35	40	42

### SMAW

-20°C	<b>LB-52 (SR)</b> <b>LB-52A</b>	<b>LB-57</b>	<b>LB-62U (SR)</b> <b>LB-62UL</b> <b>LB-62 (SR)</b>
-40°C	<b>LB-7018-1 (DCEP)</b> <b>LB-52NSU (SR)</b>	<b>LB-52NSU (AC, SR)</b> <b>LB-52NS (AC)</b>	<b>LB-55NS (DCEP)</b> <b>NB-1SJ (AC, SR)</b> <b>LB-62L (SR)</b>
-60°C	<b>NB-1SJ (SR)</b> <b>LB-52NS (SR)</b>	<b>NB-1SJ (SR)</b>	

### FCAW, GMAW

-20°C	<b>DW-100E (CO<sub>2</sub>)</b> <b>MG-S50 (Ar-20%CO<sub>2</sub>)</b>		<b>DW-55L (CO<sub>2</sub>)</b> <b>MG-T1NS (Ar-20%CO<sub>2</sub>)</b> <b>DW-A62LSR (Ar-20%CO<sub>2</sub>, SR)</b>
-30°C	<b>DW-100KS (CO<sub>2</sub>)</b> <b>DW-55E (CO<sub>2</sub>)</b>		
-40°C	<b>DW-A55E (Ar-20%CO<sub>2</sub>)</b> <b>DW-A55ESR (do., SR)</b>		
-50°C	<b>DW-50LSR (CO<sub>2</sub>)</b>	<b>DW-55LSR (CO<sub>2</sub>, SR)</b> <b>DW-A55L (Ar-20%CO<sub>2</sub>)</b>	<b>DW-A81Ni1 (Ar-20%CO<sub>2</sub>)</b>
-60°C	<b>DW-55L (CO<sub>2</sub>)</b> <b>DW-A55L (Ar-20%CO<sub>2</sub>)</b> <b>MG-S50LT (do., SR)</b> <b>MX-A55Ni1 (do.)</b>	<b>DW-A55LSR (do., SR)</b> <b>MG-S50LT (do.)</b> <b>MX-A55Ni1 (do.)</b>	<b>DW-55LSR (CO<sub>2</sub>)</b> <b>DW-A55L (Ar-20%CO<sub>2</sub>)</b> <b>DW-A55LSR (do.)</b> <b>MX-A55Ni1 (do.)</b>

### GTAW

-20°C	<b>TG-S50 (SR)</b>	<b>TG-S62 (SR)</b>
-30°C	<b>TG-S51T (SR)</b>	
-40°C	<b>TG-S1MT</b>	<b>TG-S60A (SR)</b>
-60°C	<b>TG-S1N</b>	

### SAW

-20°C	<b>MF-38/US-36 (AC, SR)</b>	<b>MF-38/US-49A (AC)</b>	
-40°C	<b>PF-H55LT/US-36</b>	<b>PF-H55S/US-49A (AC, SR)</b>	<b>PF-H80AK/US-56B (DCEP)</b>
-60°C	<b>PF-H55AS/US-36J</b> (AC, SR) <b>PF-H55AS/US-36J</b> (DCEP, SR)	<b>PF-H55LT/US-36 (AC)</b> <b>PF-H55LT/US-36J (do., SR)</b> <b>PF-H55AS/US-36J (DCEP)</b> <b>PF-H58AS/US-36J (do.)</b>	<b>PF-H55LT/US-36J (AC)</b>

#### Tips for successful welding results

1. Users are requested to confirm whether the selected brand (Trademark + Trade designation) can satisfy the job specifications including ship-class approvals and other specific requirements before use. The Charpy impact absorbed energies are the average of three testing specimens. Yield strength includes yield point and 0.2% offset strength.

	610 500 50	670 550 55	770 690 69
	<b>LB-62U (SR)</b> <b>LB-62UL</b> <b>LB-62 (SR)</b>	<b>LB-106</b>	<b>LB-80UL (AC)</b> <b>LB-116 (AC, DCEP)</b>
	<b>LB-62L (AC, SR)</b> <b>LB-65L (DCEP)</b> <b>LB-67L (do.)</b>	<b>LB-70L (DCEP)</b> <b>LB-Y75 (AC)</b>	<b>LB-88LT (AC)</b> <b>LB-80L (DCEP)</b>
	<b>DW-A65L (Ar-20%CO<sub>2</sub>)</b> <b>MG-T1NS (do.)</b> <b>DW-A65Ni1 (Ar-20%CO<sub>2</sub>)</b>	<b>MG-S70 (Ar-20%CO<sub>2</sub>)</b> <b>DW-A70L (Ar-20%CO<sub>2</sub>)</b>	<b>MG-S80 (Ar-20%CO<sub>2</sub>)</b> <b>DW-A80L (Ar-20%CO<sub>2</sub>)</b>
	<b>DW-62L (CO<sub>2</sub>)</b> <b>DW-A62L (Ar-20%CO<sub>2</sub>)</b> <b>DW-A62LSR (do.)</b> <b>MX-A62L (do.)</b>	-	<b>MG-S88A (Ar-20%CO<sub>2</sub>)</b> <b>MX-A80L (do.)</b>
		<b>TG-S80AM (SR)</b>	<b>TG-S80AM</b>
	<b>MF-38/US-40 (AC)</b> <b>PF-H55S/US-40 (AC)</b> <b>PF-H80AK/US-56B</b>	<b>PF-H80AS/US-255 (DCEP)</b> <b>PF-H80AK/US-255 (AC)</b>	<b>PF-H80AK/US-80LT (AC)</b> <b>PF-H80AS/US-80LT (DCEP)</b>
	<b>PF-H80AK/US-56B (AC)</b> <b>PF-H55S/US-2N (do., SR)</b> <b>PF-H62AS/US-2N (DCEP)</b> <b>PF-H62AK/US-2N (AC, SR)</b>		

- Mechanical properties of weld metal may adversely be affected by postweld heat treatment (PWHT). Therefore, the trade designations having no designation of "SR" in the parentheses are recommended to use in the as-welded condition, whereas the brands having the SR designation can be used in the PWHT condition as well as in the as-welded condition.
- A change of polarity may affect the usability of welding consumables, and the chemical composition and mechanical properties of weld metals; therefore, use the polarity as indicated in the parentheses.

# SMAW, FCAW, GMAW, GTAW, SAW

## Tips for better welding results

### Common

- (1) Use an appropriate welding procedure taking into account the requirements for the mechanical properties of the weldment, because heat input, Interpass temperature and plate thickness affect the cooling rate of welds and, where the cooling rate is excessively low, the tensile strength and notch toughness of the weld decrease.
- (2) Use appropriate preheat and interpass temperatures to prevent cold cracking assisted by the diffusible hydrogen in welds. Suitable preheat and interpass temperatures vary depending upon welding process, plate thickness, and kind of steel plate. In general, higher tensile strength steels need higher preheat and interpass temperatures.
- (3) Select appropriate welding consumables and welding conditions carefully particularly in cases where the weld metal dilution by the base metal is large, because the chemical composition of the weld metal can remarkably be affected by the base metal chemical composition and thereby the properties of the weld metal can be varied.
- (4) Confirm the applicability of postweld heat treatment for welding consumables before use, because some welding consumables can provide good notch toughness only in the as-welded condition and some welding consumables can provide sufficient notch toughness in the postweld heat treated conditions.
- (5) Confirm the suitable electric current characteristics for welding consumables before use, because each welding consumable is designed to provide the highest performances with specific type of electric current (AC, DC, or both) and polarity (DCEP, DCEN, or both). Therefore, when a welding consumable designed for AC is used in DC or in opposite case, there are possibilities to deteriorate the properties of the weld metal and usability.
- (6) Some welding consumable can be used by both AC and DCEP; however, the use of DCEP causes a little decrease in strength of the weld metal.

### SMAW

- (1) Low-hydrogen type electrodes should be stored in an oven (100-150°C) placed near the welding area after re-drying was finished. Take out minimum amounts of electrodes needed for a certain work from the oven. This manner is to keep the diffusible hydrogen content of the weld metal in a low level.
- (2) Use the backstep technique directly in the welding groove or strike an arc on a scrap plate before transferring the arc into the groove to prevent cracking.
- (3) Keep the arc length as short as possible to maintain good shielding by the coating flux decomposed gases during welding. The use of a long arc can cause a decrease of impact value of the weld metal caused by the nitrogen in the atmosphere and, where the arc length is excessive, blowholes can occur in the weld metal. Use a wind screen in windy areas.
- (4) Refer to the tips for Mild Steel and 490MPa High Tensile Strength Steel for other notes.

## FCAW, GMAW, and GTAW

- (1) Use suitable shielding gas for each welding wire because the composition of a shielding gas can affect the mechanical properties of the weld metal.
- (2) Use a wind screen in windy areas to maintain the shielding gas in good condition. Insufficient or irregular shielding gas can cause weld defects.
- (3) Refer to the tips for welding Mild Steel and 490MPa High Tensile Strength Steel for other notes.

## SAW

- (1) Remove rust, oil, grease, and water in the welding groove beforehand because such dirt can cause weld defects like pits and blowholes.
- (2) Select suitable steel plates and welding consumables carefully taking into account the dilution of weld metal by the base metal. Submerged arc welding characterizes deeper penetration and thus larger dilution; therefore, the properties of the weld metal can remarkably be varied by the chemical composition of the base metal. Especially in the single-pass-on-both-side welding, the dilution ratio becomes as large as about 60% and thus the properties of the weld metal is considerably affected by the chemical composition of the base metal.
- (3) Refer to the tips for Mild Steel and 490MPa High Tensile Strength Steel for other notes.

## How to prevent cold cracks

In order to prevent cold cracks in arc welding, preheat temperature is a key factor, which relates to the hardenability of the steel material, the amount of diffusible hydrogen in the weld metal, and the degree of restraint of the welding joint. Fig. 1 shows the relationship between preheat temperature and the Cracking Parameter ( $P_C$ ) which consists of the Cracking Parameter of Material ( $P_{CM}$ ), plate thickness ( $t$ ), and diffusible hydrogen ( $H$ ). This diagram was developed through the y-groove cracking test of high tensile strength steels having a variety of chemical compositions. It can be considered that  $P_{CM}$  relates to the hardenability of a steel material, and plate thickness relates to the degree of restraint of a welding joint. Hence,  $P_C$  can be a guide to estimating the preheat temperature needed for preventing a cold crack in arc welding of a particular steel material.

However, in the stricter sense, the following formula ( $P_W$ ) is more recommended to use for estimating the cooling time after welding that relates to preheat temperature, heat input, ambient temperature, and other factors to prevent a cold crack in arc welding of actual steel structures. The applicable ranges of individual parameters are given in Table 1.

$$P_W = P_{CM} + H/60 + R_F/400,000$$

where  $P_{CM}$  (%): the same as that contained in the  $P_C$  formula

$R_F$  (N/mm $\cdot$ mm): the degree of restraint of a welding joint

The degree of restraint (N/mm $\cdot$ mm) of a y-groove welding joint used for developing  $P_C$  is about 700 times the plate thickness (mm); if  $R_F$  is substituted by  $700 \times t$ ,  $P_W$  becomes almost the same as  $P_C$ .

# SMAW, FCAW, GMAW, GTAW, SAW

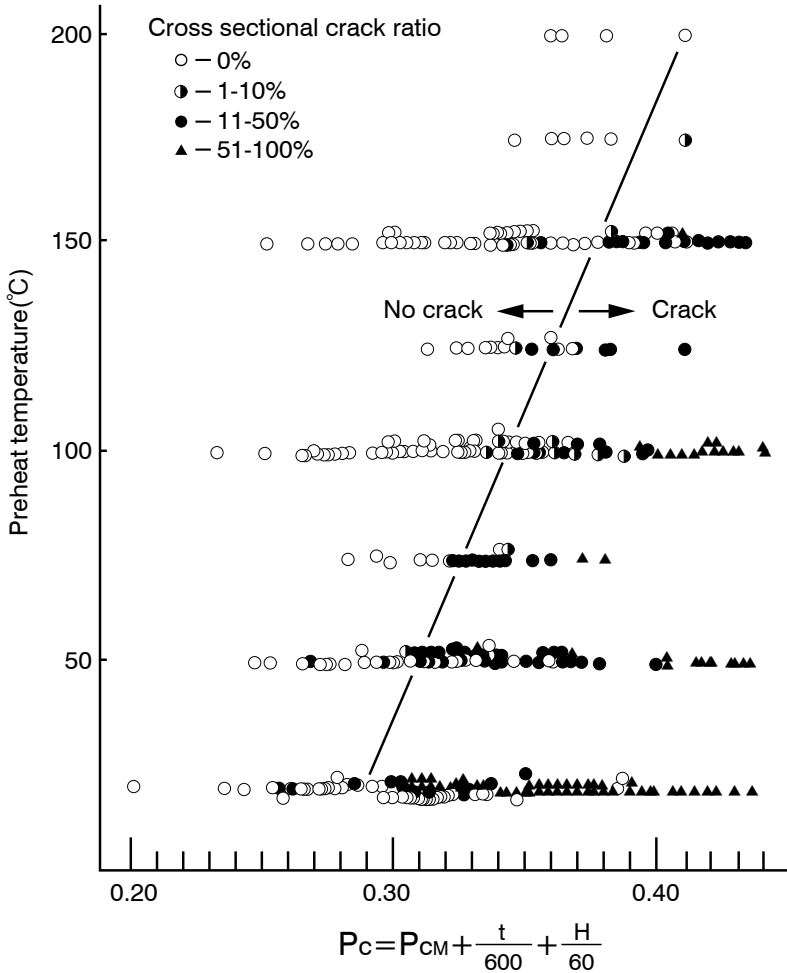

Fig. 1 Preheat temperature vs. cracking parameter  $P_c$  ( $t$ : 16-50 mm)

$$P_{CM} = C + Si/30 + Mn/20 + Cu/20 + Ni/60 + Cr/20 + Mo/15 + V/10 + 5B (\%)$$

$t$ : Plate thickness (mm)

$H$ : Content of diffusible hydrogen of deposited metal (Glycerine method) (ml/100 g)

$H$  (Glycerine method) = 0.79 $H$  (Gas chromatography method) - 1.73

Table 1 Applicable ranges of parameters for Pw formula

Chemical composition of steels (%) <sup>a</sup>										
C	Si	Mn	Cu	Ni	Cr	Mo	V	Ti	Nb	B
0.07~ 0.22	0.60	0.40~ 1.40	0.50	1.20	1.20	0.70	0.12	0.05	0.04	0.005
Amount of diffusible hydrogen, H				Plate thickness, t			Degree of restraint, R <sub>F</sub>			
1.0~5.0 ml/100g				19~50 mm			5,000~33,000 N/mm·mm			

Note: <sup>a</sup> Single values are maximum.

$$P_w = P_{CM} + H/60 + R_F/400,000$$

(References: WES 3001-1996 and JIS Z 3118-1992)

## Stick electrode

**Features:** ▪ Suitable for low temperature service steel

**Classification:** AWS A5.1 E7018-1

**Redrying Conditions:** 350~400°Cx1h

**Identification color:** 1st Brown, 2nd White

**Polarity:** AC, DCEP

## Welding Positions:

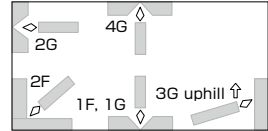

## Packaging data

φ mm	Length mm	kg/pack	kg/carton	g/piece	carton mm
2.6	350	5	20	23	170W, 105H, 380L
3.2	350	5	20	35	170W, 105H, 380L
4.0	400	5	20	61	170W, 105H, 430L
4.0	450	5	20	69	170W, 100H, 480L
5.0	450	5	20	106	170W, 110H, 480L

## Composition (all-weld metal mass%)

	Typical (DCEP)	Guaranty <sup>a</sup>
<b>C</b>	0.08	0.15
<b>Si</b>	0.37	0.75
<b>Mn</b>	1.53	1.60
<b>P</b>	0.012	0.035
<b>S</b>	0.003	0.035
<b>Ni</b>	0.01	0.30
<b>Cr</b>	0.03	0.20
<b>Mo</b>	0.01	0.30
<b>V</b>	<0.01	0.08
<b>Ti</b>	0.025	-
<b>B</b>	0.0045	-
<b>Others<sup>b</sup></b>	1.58	1.75

Note: <sup>a</sup> Single values are maximum.

<sup>b</sup> Combined Limit for Mn+Ni+Cr+Mo+V

## Welding parameters (A)

φ mm	1F, 1G, 2F, 2G	3G uphill, 4G
2.6	70~100	65~95
3.2	90~130	80~120
4.0	130~180	110~170
5.0	180~240	-

## All-weld mechanical properties

	Typical (DCEP)	Guaranty
<b>0.2%YS (MPa)</b>	490	400min.
<b>TS (MPa)</b>	580	483min.
<b>EI on 4d (%)</b>	31	22min.
<b>IV -46°C (J)</b>	135	27min.

## Approvals

<b>ABS</b>	4Y400, H10
<b>LR</b>	4Y40m H10



## Stick electrode

**Features:** • Suitable for 3.5%Ni steel  
**Classification:** AWS A5.5 E7016-C2L  
**Redrying Conditions:** 350~400°Cx1h  
**Identification color:** 1st Yellow green, 2nd Silver grey  
**Polarity:** AC

## Welding Positions:

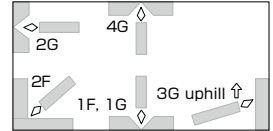

## Packaging data

φ mm	Length mm	kg/pack	kg/carton	g/piece	carton mm
3.2	350	5	20	32	170W, 120H, 380L
4.0	400	5	20	56	170W, 110H, 430L

## Composition (all-weld metal mass%)

	Typical	Guaranty <sup>a</sup>
<b>C</b>	0.05	0.05
<b>Si</b>	0.36	0.50
<b>Mn</b>	0.73	1.25
<b>P</b>	<0.01	0.03
<b>S</b>	<0.01	0.03
<b>Ni</b>	3.50	3.00~3.75

## Welding parameters (A)

φ mm	1F, 1G, 2F, 2G	3G uphill, 4G
3.2	90~130	80~120
4.0	130~170	110~150

Note: <sup>a</sup> Single values are maximum.

## All-weld mechanical properties

	Typical		Guaranty
<b>0.2%YS (MPa)</b>	470	440	393min.
<b>TS (MPa)</b>	560	530	483min.
<b>EI on 4d (%)</b>	31	35	25min.
<b>IV (J)</b>	-85°C:170	-100°C:140	-101°C: 27min.
<b>PWHT (°C×h)</b>	AW	605x1	AW & 605±15x1

## Stick electrode

## Features:

- Good CTOD properties down to -10°C
- Better impact values down to -60°C
- AC is recommended for 570 to 610MPa class steel

**Classification:** AWS A5.5 E8016-C1

**Redrying Conditions:** 350~400°Cx1h

**Identification color:** 1st Blue, 2nd Orange

**Polarity:** AC, DCEP

## Welding Positions:

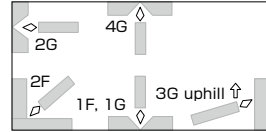

## Packaging data

φ mm	Length mm	kg/pack	kg/carton	g/piece	carton mm
3.2	350	5	20	31	170W, 120H, 380L
4.0	400	5	20	55	170W, 120H, 430L
5.0	450	5	20	97	170W, 110H, 480L

## Composition (all-weld metal mass%)

	Typical (AC)	Guaranty <sup>a</sup>
<b>C</b>	0.07	0.12
<b>Si</b>	0.36	0.60
<b>Mn</b>	0.86	1.25
<b>P</b>	0.01	0.03
<b>S</b>	<0.01	0.03
<b>Ni</b>	2.40	2.00~2.75
<b>Mo</b>	0.12	-
<b>Ti</b>	0.018	-
<b>B</b>	0.0021	-

## Welding parameters (A)

φ mm	1F, 1G, 2F, 2G	3G uphill, 4G
3.2	90~130	80~120
4.0	130~180	100~170
5.0	180~240	-

Note: <sup>a</sup> Single values are maximum.

## All-weld mechanical properties

	Typical (AC)		Guaranty
<b>0.2%YS (MPa)</b>	540	530	462min.
<b>TS (MPa)</b>	650	640	552min.
<b>EI on 4d (%)</b>	27	28	19min.
<b>IV -60°C (J)</b>	130	120	27min.
<b>PWHT (°C×h)</b>	AW	608x1	AW & 605±15x1

## Approvals

<b>ABS</b>	5YQ500 H5, MG
<b>LR</b>	5Y50m (H5)
<b>DNV</b>	5Y50 H5

## Stick electrode

## Features:

- Suitable for 610MPa tensile strength steel
- Good impact values down to -60°C
- Excellent crack resistibility

## Welding Positions:

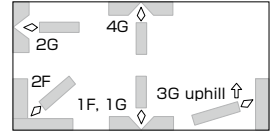

**Classification:** AWS A5.5 E8016-C1

**Redrying Conditions:** 350~400°Cx1h

**Identification color:** 1st White, 2nd Yellow

**Polarity:** DCEP

## Packaging data

φ mm	Length mm	kg/pack	kg/carton	g/piece	carton mm
3.2	350	5	20	31	170W, 120H, 380L
4.0	400	5	20	55	170W, 120H, 430L
5.0	450	5	20	97	170W, 110H, 480L

## Composition (all-weld metal mass%)

	Typical	Guaranty <sup>a</sup>
<b>C</b>	0.06	0.12
<b>Si</b>	0.42	0.60
<b>Mn</b>	1.00	1.25
<b>P</b>	<0.01	0.03
<b>S</b>	<0.01	0.03
<b>Ni</b>	2.58	2.00~2.75
<b>Mo</b>	0.12	-

## Welding parameters (A)

φ mm	1F, 1G, 2F, 2G	3G uphill, 4G
3.2	80~120	70~110
4.0	120~170	90~160
5.0	170~230	-

Note: <sup>a</sup> Single values are maximum.

## All-weld mechanical properties

	Typical		Guaranty
<b>0.2%YS (MPa)</b>	570	560	462min.
<b>TS (MPa)</b>	660	645	552min.
<b>EI on 4d (%)</b>	27	28	19min.
<b>IV -60°C (J)</b>	120	110	27min.
<b>PWHT (°Cxh)</b>	AW	605x1	AW & 605±15x1

## Stick electrode

## Features:

- Good CTOD properties at temperatures down to -30°C
- Better impact values at temperatures down to -60°C

## Welding Positions:

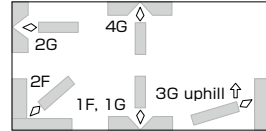

**Classification:** AWS A5.5 E7016-G

**Redrying Conditions:** 350~400°Cx1h

**Identification color:** 1st White, 2nd Green

**Polarity:** AC, DCEP

## Packaging data

φ mm	Length mm	kg/pack	kg/carton	g/piece	carton mm
2.6	350	2	20	17	170W, 120H, 380L
3.2	350	5	20	31	170W, 120H, 380L
4.0	400	5	20	55	170W, 110H, 430L
5.0	450	5	20	97	170W, 105H, 480L
6.0	450	5	20	140	170W, 105H, 480L

## Composition (all-weld metal mass%)

	Typical (AC)	Guaranty <sup>a</sup>
<b>C</b>	0.06	0.10
<b>Si</b>	0.36	0.20~0.90
<b>Mn</b>	1.38	1.00~1.60
<b>P</b>	0.01	0.03
<b>S</b>	<0.01	0.03
<b>Ni</b>	0.46	0.30~0.70
<b>Ti</b>	0.019	0.005~0.035
<b>B</b>	0.0027	0.0005~0.0045

## Welding parameters (A)

φ mm	1F, 1G, 2F, 2G	3G uphill, 4G
2.6	55~85	50~80
3.2	90~130	80~120
4.0	130~180	110~170
5.0	180~240	150~200
6.0	250~310	-

Note: <sup>a</sup>Single values are maximum.

## All-weld mechanical properties

	Typical (AC)		Guaranty
	490	470	
<b>0.2%YS (MPa)</b>	490	470	393min.
<b>TS (MPa)</b>	580	570	483min.
<b>EI on 4d (%)</b>	29	31	25min.
<b>IV -60°C (J)</b>	130	120	27min.
<b>PWHT (°Cxh)</b>	AW	620x1	AW & 620±15x1

## Approvals

<b>ABS</b>	3Y, 4Y400, MG, H10
<b>LR</b>	5Y40m (H15)
<b>DNV</b>	5Y40H10, VL2-4 (L), 4-4 (L)
<b>BV</b>	4Y40M, H10 (KV-60), UP
<b>NK</b>	KMWL3 H10, KMW54Y40

## Stick electrode

- Features:**
- Suitable for one-side welding
  - Good arc stability in one-side welding with relatively low current
  - Good impact values down to -60°C

**Classification:** AWS A5.5 E7016-G

**Redrying Conditions:** 350~400°Cx1h

**Identification color:** 1st White, 2nd Pink

**Polarity:** AC, DCEP

## Welding Positions:

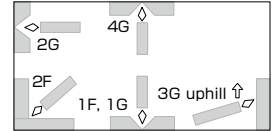

## Packaging data

φ mm	Length mm	kg/pack	kg/carton	g/piece	carton mm
2.6	350	5	20	20	170W, 120H, 380L
3.2	400	5	20	35	170W, 105H, 430L

## Composition (all-weld metal mass%)

	Typical (DCEP)	Guaranty <sup>a</sup>
<b>C</b>	0.06	0.10
<b>Si</b>	0.62	0.30~0.90
<b>Mn</b>	1.25	1.00~1.60
<b>P</b>	0.02	0.03
<b>S</b>	<0.01	0.03
<b>Ni</b>	0.50	0.30~0.70
<b>Ti</b>	0.01	-
<b>B</b>	0.003	-

Note: <sup>a</sup> Single values are maximum.

## Welding parameters (A)

φ mm	1F, 1G, 2F, 2G	3G uphill, 4G	Root pass <sup>b</sup>
2.6	60~90	50~80	30~80
3.2	90~130	80~120	60~110

Note: <sup>b</sup> DCEN is also suitable

## All-weld mechanical properties

	Typical (DCEP)		Guaranty
<b>0.2%YS (MPa)</b>	510	500	393min.
<b>TS (MPa)</b>	600	590	483min.
<b>EI on 4d (%)</b>	32	33	22min.
<b>IV -60°C (J)</b>	60	55	27min.
<b>PWHT (°Cxh)</b>	AW	620x1	AW & 620±15x1

## Approvals

<b>ABS</b>	5Y400 H10
<b>LR</b>	5Y40m (H10)
<b>DNV</b>	5Y40 H10
<b>BV</b>	5Y40 H10

## Stick electrode

## Features:

- Suitable for butt and fillet welding
- Good impact values down to -60°C
- Ni Content is normally 1% max.

**Classification:** AWS A5.5 E8016-G

**Redrying Conditions:** 350~400°Cx1h

**Identification color:** 1st Purple, 2nd Green

**Polarity:** DCEP

## Welding Positions:

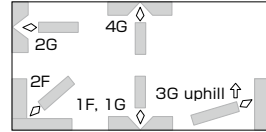

## Packaging data

φ mm	Length mm	kg/pack	kg/carton	g/piece	carton mm
2.6	300	2	20	17	270W, 90H, 330L
3.2	350	5	20	31	170W, 120H, 380L
4.0	400	5	20	55	170W, 110H, 430L
5.0	450	5	20	97	170W, 105H, 480L

## Composition (all-weld metal mass%)

	Typical	Guaranty <sup>a</sup>
<b>C</b>	0.06	0.10
<b>Si</b>	0.35	0.30~0.90
<b>Mn</b>	1.40	1.00~1.60
<b>P</b>	0.01	0.03
<b>S</b>	<0.01	0.03
<b>Ni</b>	0.93	0.70~1.0
<b>Mo</b>	0.10	0.05~0.15
<b>Ti</b>	0.018	0.005~0.035
<b>B</b>	0.0025	0.0005~0.0045

## Welding parameters (A)

φ mm	1F, 1G, 2F, 2G	3G uphill, 4G
2.6	55~85	50~80
3.2	90~130	80~120
4.0	130~180	110~170
5.0	180~240	150~200

Note: <sup>a</sup> Single values are maximum.

## All-weld mechanical properties

	Typical		Guaranty
<b>0.2%YS (MPa)</b>	520	510	462min.
<b>TS (MPa)</b>	610	590	552min.
<b>EI on 4d (%)</b>	33	31	19min.
<b>IV -60°C (J)</b>	170	140	27min.
<b>PWHT (°C×h)</b>	AW	605x1	AW & 605±15x1

## Approvals

<b>ABS</b>	5YQ420 H5
<b>LR</b>	5Y42m (H5)
<b>DNV</b>	5Y42 H5

## Stick electrode

**Features:**

- Good CTOD properties down to -45°C
- Good impact values down to -80°C

**Classification:** AWS A5.5 E8016-G

**Redrying Conditions:** 350~400°Cx1h

**Identification color:** 1st White, 2nd Brown

**Polarity:** AC

## Welding Positions:

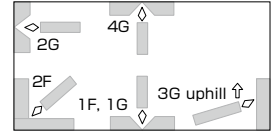

## Packaging data

$\phi$ mm	Length mm	kg/pack	kg/carton	g/piece	carton mm
2.6	300	2	20	17	270W, 90H, 330L
3.2	350	5	20	31	170W, 120H, 380L
4.0	400	5	20	55	170W, 120H, 430L
5.0	450	5	20	97	170W, 110H, 480L

## Composition (all-weld metal mass%)

	Typical	Guaranty <sup>a</sup>
<b>C</b>	0.07	0.10
<b>Si</b>	0.43	0.15~0.50
<b>Mn</b>	1.36	1.10~1.70
<b>P</b>	0.01	0.03
<b>S</b>	<0.01	0.03
<b>Ni</b>	1.37	1.10~1.70
<b>Ti</b>	0.021	0.005~0.035
<b>B</b>	0.0035	0.0005~0.0045

Note: <sup>a</sup> Single values are maximum.

## Recommended welding parameters

$\phi$ mm	1F, 1G, 2F, 2G	3G uphill, 4G
2.6	55~85	50~80
3.2	90~130	80~120
4.0	130~180	110~170
5.0	180~240	150~200

## All-weld mechanical properties

	Typical		Guaranty
	520	490	
<b>0.2%YS (MPa)</b>	520	490	462min.
<b>TS (MPa)</b>	610	580	552min.
<b>EI on 4d (%)</b>	29	29	19min.
<b>IV -80°C (J)</b>	127	130	-60°C: 27min.
<b>PWHT (°C×h)</b>	AW	620x1	AW & 620±15x1

## Approvals

<b>ABS</b>	5YQ420 H5
<b>LR</b>	5YQ40m H5
<b>DNV</b>	5YH5, VL2-4L, 4-4L
<b>BV</b>	5Y40M H5
<b>NK</b>	KMW5Y42 H5

## Stick electrode

- Features:**
- Suitable for butt and fillet welding
  - Typical stick electrode in this classification

**Classification:** AWS A5.5 E9016-G

**Redrying Conditions:** 350~400°Cx1h

**Identification color:** 1st Blue white, 2nd Yellow

**Polarity:** AC, DCEP

## Welding Positions:

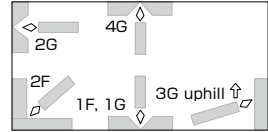

## Packaging data

φ mm	Length mm	kg/pack	kg/carton	g/piece	carton mm
2.6	300	2	20	17	270W, 90H, 330L
3.2	350	5	20	30	170W, 120H, 380L
4.0	400	5	20	55	170W, 110H, 430L
5.0	400	5	20	85	170W, 120H, 430L
6.0	450	5	20	140	170W, 105H, 480L

## Composition (all-weld metal mass%)

	Typical (AC)	Guaranty <sup>a</sup>
<b>C</b>	0.06	0.09
<b>Si</b>	0.66	0.40~0.80
<b>Mn</b>	1.04	0.75~1.35
<b>P</b>	0.01	0.03
<b>S</b>	<0.01	0.03
<b>Ni</b>	0.61	0.40~0.75
<b>Mo</b>	0.26	0.20~0.40

Note: <sup>a</sup> Single values are maximum.

## Welding parameters (A)

φ mm	1F, 1G, 2F, 2G	3G uphill, 4G
2.6	55~85	50~80
3.2	90~130	80~115
4.0	130~180	110~170
5.0	180~240	150~200
6.0	250~310	-

## All-weld mechanical properties

	Typical (AC)	Guaranty
<b>0.2%YS (MPa)</b>	550	531min.
<b>TS (MPa)</b>	650	621min.
<b>EI on 4d (%)</b>	30	17min.
<b>IV -18°C (J)</b>	150	-

## Approvals

<b>ABS</b>	3YQ500 H10
<b>LR</b>	3Y50m H10
<b>NK<sup>a)</sup></b>	KMW3Y50 H10
<b>CR</b>	3Y50 H10

Note: <sup>a)</sup> AC



## Stick electrode

<b>Features:</b>	• Excellent crack resistibility
<b>Classification:</b>	AWS A5.5 E9016-G
<b>Redrying Conditions:</b>	350~430°Cx1h
<b>Identification color:</b>	1st Brown, 2nd Silver
<b>Polarity:</b>	AC, DCEP

## Welding Positions:

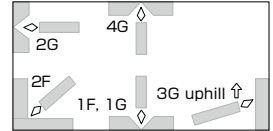

## Packaging data

$\phi$ mm	Length mm	kg/pack	kg/carton	g/piece	carton mm
3.2	350	5	20	31	170W, 120H, 380L
4.0	400	5	20	55	170W, 120H, 430L
5.0	400	5	20	85	170W, 125H, 430L

## Composition (all-weld metal mass%)

	Typical (AC)	Guaranty <sup>a</sup>
<b>C</b>	0.07	0.09
<b>Si</b>	0.68	0.40~0.80
<b>Mn</b>	1.13	0.75~1.35
<b>P</b>	0.01	0.03
<b>S</b>	<0.01	0.03
<b>Ni</b>	0.65	0.45~0.80
<b>Mo</b>	0.25	0.20~0.40

Note: <sup>a</sup> Single values are maximum.

## Welding parameters (A)

$\phi$ mm	1F, 1G, 2F, 2G	3G uphill, 4G
3.2	90~130	80~115
4.0	130~180	110~170
5.0	180~240	150~200

## All-weld mechanical properties

	Typical (AC)	Guaranty
<b>0.2%YS (MPa)</b>	550	531min.
<b>TS (MPa)</b>	650	621min.
<b>El on 4d (%)</b>	30	17min.
<b>IV -18°C (J)</b>	160	-

## Approvals

<b>NK</b>	KMW63Y47
<b>CCS</b>	3Y50 H10

## Stick electrode

## Features:

- Suitable for one-side welding
- Good arc stability with relatively low currents
- Excellent crack resistibility

**Classification:** AWS A5.5 E9016-G

**Redrying Conditions:** 350~400°Cx1h

**Identification color:** 1st Blue, 2nd Yellow

**Polarity:** AC, DCEP, DCEN (Root pass only)

## Welding Positions:

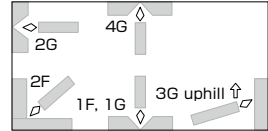

## Packaging data

φ mm	Length mm	kg/pack	kg/carton	g/piece	carton mm
2.6	350	5	20	20	170W, 120H, 380L
3.2	350	5	20	30	170W, 120H, 380L
4.0	400	5	20	53	170W, 110H, 430L

## Composition (all-weld metal mass%)

	Typical (DCEP)	Guaranty <sup>a</sup>
<b>C</b>	0.08	0.09
<b>Si</b>	0.70	0.20~0.75
<b>Mn</b>	1.08	0.70~1.35
<b>P</b>	0.01	0.03
<b>S</b>	<0.01	0.03
<b>Ni</b>	0.62	0.45~0.80
<b>Mo</b>	0.25	0.20~0.40

Note: <sup>a</sup>Single values are maximum.

## Welding parameters (A)

φ mm	1F, 1G, 2F, 2G	3G uphill, 4G	Root pass
2.6	60~90	50~80	30~80
3.2	90~130	80~115	60~110
4.0	130~180	110~170	90~140

## All-weld mechanical properties

	Typical (DCEP)	Guaranty
<b>0.2%YS (MPa)</b>	560	531min.
<b>TS (MPa)</b>	650	621min.
<b>EI on 4d (%)</b>	26	17min.
<b>IV -20°C (J)</b>	88	-

## Approvals

<b>ABS</b>	3YQ500 H10
<b>LR</b>	3Y50m H10

## Stick electrode

- Features:**
- Good CTOD properties down to -20°C
  - Better impact values down to -60°C
  - Excellent crack resistibility

**Classification:** AWS A5.5 E9016-G

**Redrying Conditions:** 350~400°Cx1h

**Identification color:** 1st White, 2nd Yellow

**Polarity:** DCEP

## Welding Positions:

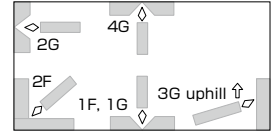

## Packaging data

φ mm	Length mm	kg/pack	kg/carton	g/piece	carton mm
2.6	300	2	20	18	270W, 90H, 330L
3.2	350	5	20	31	170W, 120H, 380L
4.0	400	5	20	55	170W, 120H, 430L
5.0	450	5	20	97	170W, 110H, 480L

## Composition (all-weld metal mass%)

	Typical	Guaranty <sup>a</sup>
<b>C</b>	0.06	0.12
<b>Si</b>	0.42	0.15~0.60
<b>Mn</b>	0.97	0.60~1.20
<b>P</b>	0.01	0.03
<b>S</b>	<0.01	0.03
<b>Ni</b>	2.55	2.00~2.75
<b>Mo</b>	0.12	0.30

Note: <sup>a</sup> Single values are maximum.

## Welding parameters (A)

φ mm	1F, 1G, 2F, 2G	3G uphill, 4G
2.6	70~100	65~95
3.2	80~120	70~110
4.0	120~170	90~160
5.0	170~230	-

## All-weld mechanical properties

	Typical		Guaranty	
<b>0.2%YS (MPa)</b>	560	560	530min.	490min.
<b>TS (MPa)</b>	660	640	620min.	590min.
<b>EI on 4d (%)</b>	29	28	17min.	16min.
<b>IV -60°C (J)</b>	130	112	27min.	27min.
<b>PWHT (°C×h)</b>	AW	620x1	AW	620±15x1

## Approvals

<b>ABS</b>	5YQ500 H5
<b>LR</b>	5Y50m, H5
<b>DNV</b>	5Y50 H5

## Stick electrode

**Features:** ▪ Suitable for 550 to 610MPa tensile strength steel

**Classification:** AWS A5.5 E9018-G

**Redrying Conditions:** 350~400°Cx1h

**Identification color:** 1st Pink, 2nd Yellow

**Polarity:** DCEP

## Welding Positions:

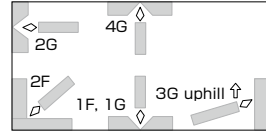

## Packaging data

φ mm	Length mm	kg/pack	kg/carton	g/piece	carton mm
3.2	350	5	20	34	170W, 120H, 380L
4.0	400	5	20	61	170W, 120H, 430L
5.0	450	5	20	93	170W, 110H, 480L

## Composition (all-weld metal mass%)

	Typical	Guaranty <sup>a</sup>
<b>C</b>	0.06	0.09
<b>Si</b>	0.68	0.40~0.75
<b>Mn</b>	1.21	0.80~1.40
<b>P</b>	0.01	0.03
<b>S</b>	<0.01	0.03
<b>Ni</b>	0.59	0.45~0.80
<b>Mo</b>	0.26	0.20~0.35

Note: <sup>a</sup>Single values are maximum.

## Welding parameters (A)

φ mm	1F, 1G, 2F, 2G	3G uphill, 4G
3.2	90~130	80~120
4.0	135~185	110~170
5.0	190~250	150~200

## All-weld mechanical properties

	Typical	Guaranty
<b>0.2%YS (MPa)</b>	570	531min.
<b>TS (MPa)</b>	660	621min.
<b>El on 4d (%)</b>	29	17min.
<b>IV -20°C (J)</b>	170	27min.

## Stick electrode

**Features:** • Suitable for 690MPa tensile strength steel

**Classification:** AWS A5.5 E10016-G

**Redrying Conditions:** 350~400°Cx1h

**Identification color:** 1st Blue white, 2nd Purple

**Polarity:** AC

## Welding Positions:

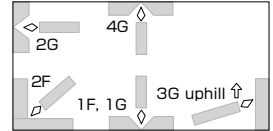

## Packaging data

φ mm	Length mm	kg/pack	kg/carton	g/piece	carton mm
3.2	350	5	20	31	170W, 120H, 380L
4.0	400	5	20	55	170W, 105H, 430L
5.0	400	5	20	85	170W, 105H, 430L

## Composition (all-weld metal mass%)

	Typical	Guaranty <sup>a</sup>
<b>C</b>	0.08	0.09
<b>Si</b>	0.65	0.40~0.75
<b>Mn</b>	1.29	1.20~1.70
<b>P</b>	0.01	0.03
<b>S</b>	<0.01	0.03
<b>Ni</b>	1.44	1.20~1.70
<b>Cr</b>	0.22	0.10~0.30
<b>Mo</b>	0.19	0.10~0.30

Note: <sup>a</sup>Single values are maximum.

## Welding parameters (A)

φ mm	1F, 1G, 2F, 2G	3G uphill, 4G
3.2	90~130	80~115
4.0	130~180	110~170
5.0	180~240	150~220

## All-weld mechanical properties

	Typical	Guaranty
<b>0.2%YS (MPa)</b>	660	600min.
<b>TS (MPa)</b>	760	690min.
<b>El on 4d (%)</b>	25	16min.
<b>IV -20°C (J)</b>	110	27min.

## Approvals

<b>ABS</b>	MG (AWS A5.5 E10016-G)
<b>NK</b>	KMW3Y62 H5
<b>CR</b>	MG (E10016-G)

## Stick electrode

## Features:

- Suitable for butt and fillet welding
- Good impact values down to -40°C
- Excellent crack resistibility

**Classification:** AWS A5.5 E10016-G

**Redrying Conditions:** 350~430°Cx1h

**Identification color:** 1st Green, 2nd Yellowish green

**Polarity:** AC

## Welding Positions:

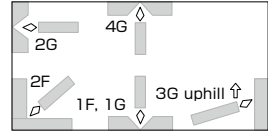

## Packaging data

φ mm	Length mm	kg/pack	kg/carton	g/piece	carton mm
3.2	350	5	20	32	170W, 120H, 380L
4.0	400	5	20	56	170W, 120H, 430L
5.0	400, 450	5	20	87, 98	170W, 110~120H, 430~480L

## Composition (all-weld metal mass%)

	Typical	Guaranty <sup>a</sup>
<b>C</b>	0.05	0.07
<b>Si</b>	0.38	0.20~0.60
<b>Mn</b>	1.21	0.80~1.40
<b>P</b>	0.01	0.03
<b>S</b>	<0.01	0.03
<b>Ni</b>	3.56	3.05~3.80
<b>Cr</b>	0.24	0.10~0.40
<b>Mo</b>	0.40	0.30~0.60

Note: <sup>a</sup> Single values are maximum.

## Welding parameters (A)

φ mm	1F, 1G, 2F, 2G	3G uphill, 4G
3.2	90~130	90~120
4.0	130~180	110~170
5.0	180~240	-

## All-weld mechanical properties

	Typical	Guaranty
<b>0.2%YS (MPa)</b>	680	600min.
<b>TS (MPa)</b>	760	690min.
<b>EI on 4d (%)</b>	23	16min.
<b>IV -40°C (J)</b>	115	27min.

## Stick electrode

- Features:**
- Suitable for butt and fillet welding
  - Good impact values down to -60°C
  - Excellent crack resistibility

**Classification:** AWS A5.5 E10016-G

**Redrying Conditions:** 350~430°Cx1h

**Identification color:** 1st Green, 2nd Yellowish green

**Polarity:** DCEP

## Welding Positions:

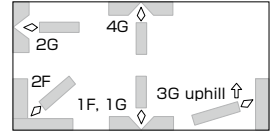

## Packaging data

φ mm	Length mm	kg/pack	kg/carton	g/piece	carton mm
3.2	350	5	20	31	170W, 120H, 380L
4.0	400	5	20	55	170W, 120H, 430L

## Composition (all-weld metal mass%)

	Typical	Guaranty <sup>a</sup>
<b>C</b>	0.04	0.07
<b>Si</b>	0.40	0.20~0.60
<b>Mn</b>	1.18	0.80~1.40
<b>P</b>	0.01	0.03
<b>S</b>	<0.01	0.03
<b>Ni</b>	3.71	3.05~3.90
<b>Cr</b>	0.22	0.10~0.40
<b>Mo</b>	0.40	0.30~0.60

Note: <sup>a</sup> Single values are maximum.

## Welding parameters (A)

φ mm	1F, 1G, 2F, 2G	3G uphill, 4G
3.2	80~120	70~110
4.0	120~170	90~160

## All-weld mechanical properties

	Typical	Guaranty
<b>0.2%YS (MPa)</b>	685	600min.
<b>TS (MPa)</b>	755	690min.
<b>EI on 4d (%)</b>	27	16min.
<b>IV -60°C (J)</b>	110	27min.

## Approvals

<b>ABS</b>	4YQ620 H5
<b>DNV</b>	4Y62 H5

Note: DCEP

## Stick electrode

**Features:** ▪ Suitable for 780MPa tensile strength steel

**Classification:** AWS A5.5 E11016-G

**Redrying Conditions:** 350~400°Cx1h

**Identification color:** 1st Blue white, 2nd Red

**Polarity:** AC, DCEP

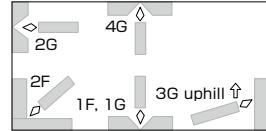
**Welding Positions:****Packaging data**

φ mm	Length mm	kg/pack	kg/carton	g/piece	carton mm
2.6	300	2	20	17	270W, 90H, 330L
3.2	350	5	20	30	170W, 120H, 380L
4.0	400	5	20	54	170W, 110H, 430L
5.0	400	5	20	86	170W, 110H, 430L

**Composition (all-weld metal mass%)**

	Typical	Guaranty <sup>a</sup>
<b>C</b>	0.07	0.09
<b>Si</b>	0.70	0.40~0.80
<b>Mn</b>	1.41	1.20~1.70
<b>P</b>	0.01	0.03
<b>S</b>	<0.01	0.03
<b>Ni</b>	1.89	1.50~2.10
<b>Cr</b>	0.28	0.20~0.40
<b>Mo</b>	0.46	0.35~0.55

**Welding parameters (A)**

φ mm	1F, 1G, 2F, 2G	3G uphill, 4G
2.6	55~85	50~80
3.2	90~130	80~115
4.0	130~180	110~170
5.0	180~240	-

Note: <sup>a</sup> Single values are maximum.

**All-weld mechanical properties**

	Typical	Guaranty
<b>0.2%YS (MPa)</b>	730	669min.
<b>TS (MPa)</b>	830	758min.
<b>EI on 4d (%)</b>	24	15min.
<b>IV -20°C (J)</b>	110	27min.



## Stick electrode

**Features:**

- Suitable for 780MPa tensile strength steel
- Ultra low hydrogen type

## Welding Positions:

**Classification:** AWS A5.5 E11016-G

**Redrying Conditions:** 350~430°Cx1h

**Identification color:** 1st Brown, 2nd Green

**Polarity:** AC

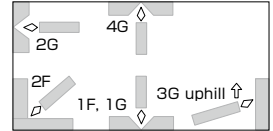

## Packaging data

φ mm	Length mm	kg/pack	kg/carton	g/piece	carton mm
3.2	350	5	20	31	170W, 120H, 380L
4.0	400	5	20	55	170W, 115H, 430L
5.0	400	5	20	87	170W, 120H, 430L

## Composition (all-weld metal mass%)

	Typical	Guaranty <sup>a</sup>
<b>C</b>	0.07	0.09
<b>Si</b>	0.59	0.35~0.70
<b>Mn</b>	1.50	1.30~1.80
<b>P</b>	0.01	0.03
<b>S</b>	<0.01	0.03
<b>Ni</b>	1.90	1.70~2.10
<b>Cr</b>	0.22	0.10~0.40
<b>Mo</b>	0.45	0.25~0.55

Note: <sup>a</sup> Single values are maximum.

## Welding parameters (A)

φ mm	1F, 1G, 2F, 2G	3G uphill, 4G
3.2	90~130	80~115
4.0	130~180	110~170
5.0	180~240	-

## All-weld mechanical properties

	Typical	Guaranty
<b>0.2%YS (MPa)</b>	710	669min.
<b>TS (MPa)</b>	820	759min.
<b>EI on 4d (%)</b>	25	15min.
<b>IV -20°C (J)</b>	110	27min.

## Approvals

<b>NK<sup>a</sup>)</b>	KMW3Y69 H5
<b>CCS</b>	3Y69 H5

Note: <sup>a</sup>) AC

## Stick electrode

**Features:**

- Good impact values down to -80°C
- Excellent crack resistibility

**Classification:** AWS A5.5 E11016-G

**Redrying Conditions:** 350~430°Cx1h

**Identification color:** 1st Brown, 2nd Brown

**Polarity:** AC

## Welding Positions:

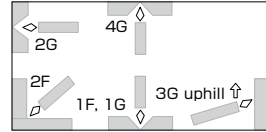

## Packaging data

φ mm	Length mm	kg/pack	kg/carton	g/piece	carton mm
3.2	350	5	20	30	170W, 120H, 380L
4.0	400	5	20	54	170W, 110H, 430L
5.0	400	5	20	87	170W, 120H, 430L

## Composition (all-weld metal mass%)

	Typical	Guaranty <sup>a</sup>
<b>C</b>	0.04	0.09
<b>Si</b>	0.70	0.40~0.75
<b>Mn</b>	1.75	1.40~2.00
<b>P</b>	0.01	0.03
<b>S</b>	<0.01	0.03
<b>Ni</b>	2.62	2.10~2.80
<b>Mo</b>	0.73	0.50~0.80

Note: <sup>a</sup>Single values are maximum.

## Welding parameters (A)

φ mm	1F, 1G, 2F, 2G	3G uphill, 4G
3.2	90~130	80~115
4.0	130~180	100~170
5.0	180~240	-

## All-weld mechanical properties

	Typical	Guaranty
<b>0.2%YS (MPa)</b>	750	669min.
<b>TS (MPa)</b>	840	759min.
<b>EI on 4d (%)</b>	20	15min.
<b>IV -80°C (J)</b>	63	27min.

## Approvals

<b>ABS</b>	5YQ690 H5
<b>DNV</b>	5Y69 H5

Note: AC only

## Stick electrode

**Features:**

- Good impact values down to -60°C
- Excellent crack resistibility

**Classification:** AWS A5.5 E11018-G H4

**Redrying Conditions:** 350~400°Cx1h

**Identification color:** 1st Brown, 2nd Brown

**Polarity:** DCEP

## Welding Positions:

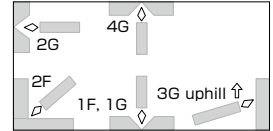

## Packaging data

φ mm	Length mm	kg/pack	kg/carton	g/piece	carton mm
2.6	300	2	20	18	270W, 90H, 330L
3.2	350	5	20	32	170W, 120H, 380L
4.0	400	5	20	57	170W, 110H, 430L
5.0	400	5	20	90	170W, 120H, 430L

## Composition (all-weld metal mass%)

	Typical	Guaranty <sup>a</sup>
<b>C</b>	0.04	0.09
<b>Si</b>	0.60	0.20~0.75
<b>Mn</b>	1.49	1.20~1.90
<b>P</b>	0.01	0.03
<b>S</b>	<0.01	0.03
<b>Ni</b>	2.92	2.50~3.30
<b>Mo</b>	0.77	0.40~1.00

Note: <sup>a</sup> Single values are maximum.

## Welding parameters (A)

φ mm	1F, 1G, 2F, 2G	3G uphill, 4G
2.6	70~100	65~95
3.2	80~120	70~110
4.0	120~160	90~150
5.0	170~210	-

## All-weld mechanical properties

	Typical	Guaranty
<b>0.2%YS (MPa)</b>	770	669min.
<b>TS (MPa)</b>	830	759min.
<b>El on 4d (%)</b>	24	15min.
<b>IV -60°C (J)</b>	100	47min.

## Approvals

<b>ABS</b>	5YQ690 H5
<b>LR</b>	5Y69m H5
<b>DNV</b>	5Y69 H5
<b>BV</b>	5Y69 H5
<b>CCS</b>	5Y69 H5

Note: DCEP only

## Flux cored wire

**Features:** • Suitable for shipping class steel down to -40°C

**Classification:** AWS A5.20 E71T-1C, E71T-9C-J

**Shielding gas:** CO<sub>2</sub>

**Polarity:** DCEP

## Welding Positions:

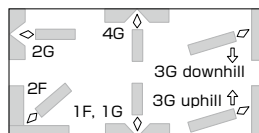

## Packaging data

φ mm	Spool		
1.2	12.5kg	15kg	20kg
1.4	12.5kg	15kg	20kg
<b>Volume mm</b>	300W, 110H, 300L		

## Composition (all-weld metal mass%)

	Typical	Guaranty <sup>a</sup>
<b>C</b>	0.05	0.12
<b>Si</b>	0.54	0.90
<b>Mn</b>	1.47	1.75
<b>P</b>	0.01	0.03
<b>S</b>	0.01	0.03
<b>Ni</b>	0.33	0.50
<b>Cr</b>	0.03	0.20
<b>Mo</b>	0.01	0.30
<b>V</b>	0.01	0.08
<b>Cu</b>	0.02	0.35

Note: <sup>a</sup>Single values are maximum.

## All-weld mechanical properties

	Typical	Guaranty
<b>0.2%YS (MPa)</b>	525	400min.
<b>TS (MPa)</b>	600	483~655
<b>EI on 4d (%)</b>	28	22min.
<b>IV -40°C (J)</b>	100	27min.

## Approvals

<b>ABS</b>	4YSA, 4Y400SA, H5
<b>LR</b>	4Y40S H5
<b>DNV</b>	IVY40MS, H10
<b>BV</b>	SA4Y40M H5
<b>NK</b>	KSW54Y40G (C) H5
<b>KR</b>	4Y40SG (C) H5

## Welding parameters (A)

φ mm	1F, 1G	2F	2G	3G uphill, 4G	3G downhill
1.2	120~300	120~300	120~280	120~260	200~300
1.4	150~400	150~350	150~320	150~270	220~300

**Flux cored wire**

**Features:** ▪ Excellent impact values down to -40°C

**Classification:** AWS A5.20 E71T-9C-J

**Shielding gas:** CO<sub>2</sub>

**Polarity:** DCEP

**Welding Positions:**

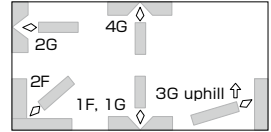

**Packaging data**

φ mm	Spool		
1.2	12.5kg	15kg	20kg
1.4	-	15kg	-
<b>Volume mm</b>	300W, 110H, 300L		

**Composition (all-weld metal mass%)**

	Typical	Guaranty <sup>a</sup>
<b>C</b>	0.05	0.12
<b>Si</b>	0.38	0.90
<b>Mn</b>	1.42	1.75
<b>P</b>	0.01	0.03
<b>S</b>	0.01	0.03
<b>Ni</b>	0.35	0.50
<b>Cr</b>	0.03	0.20
<b>Mo</b>	0.01	0.30
<b>V</b>	0.02	0.08
<b>Cu</b>	0.02	0.35

Note: <sup>a</sup> Single values are maximum.

**All-weld mechanical properties**

	Typical	Guaranty
<b>0.2%YS (MPa)</b>	540	400min.
<b>TS (MPa)</b>	590	483~655
<b>El on 4d (%)</b>	29	22min.
<b>IV -40°C (J)</b>	80	27min.

**Approvals**

<b>ABS</b>	4Y400SA, H5
<b>LR</b>	4Y40S, H5
<b>DNV</b>	IVYMS (H5)
<b>BV</b>	SA4YM H5
<b>NK</b>	KSW54Y40G (C) H5
<b>CR</b>	3YS-HH, L1YS-HH, MG
<b>CCS</b>	4Y40S, H5

**Welding parameters (A)**

φ mm	1F, 1G	2F	2G	3G uphill, 4G
1.2	150~300	150~300	150~280	150~250
1.4	150~400	150~350	150~300	150~250

## Flux cored wire

**Features:** • Excellent impact values down to -40°C

**Classification:** AWS A5.20 E71T-9M-J

**Shielding gas:** Ar-20%CO<sub>2</sub>

**Polarity:** DCEP

## Welding Positions:

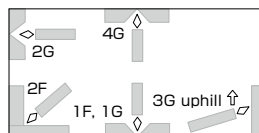

## Packaging data

φ mm	Spool	
1.2	12.5kg	15kg
Volume mm	300W, 110H, 300L	

## Composition (all-weld metal mass%)

	Typical	Guaranty <sup>a</sup>
<b>C</b>	0.05	0.12
<b>Si</b>	0.54	0.90
<b>Mn</b>	1.31	1.75
<b>P</b>	0.01	0.03
<b>S</b>	0.01	0.03
<b>Ni</b>	0.34	0.50
<b>Cr</b>	0.02	0.20
<b>Mo</b>	0.01	0.30
<b>Cu</b>	0.02	0.35
<b>V</b>	0.01	0.08

Note: <sup>a</sup> Single values are maximum.

## All-weld mechanical properties

	Typical	Guaranty
<b>0.2%YS (MPa)</b>	540	400min.
<b>TS (MPa)</b>	600	483~655
<b>EI on 4d (%)</b>	28	22min.
<b>IV -40°C (J)</b>	100	27min.

## Approvals

<b>ABS</b>	4Y400SA (H5)
<b>LR</b>	4Y40S, H5
<b>DNV</b>	IVYMS (H5)
<b>BV</b>	SA4Y40M H5

## Welding parameters (A)

φ mm	1F, 1G	2F	2G	3G uphill, 4G
1.2	150~300	150~300	150~280	150~250

# DW-A55ESR

## Flux cored wire

**Features:** ▪ Excellent impact value down to -46°C

**Classification:** AWS A5.20 E71T-12M-J

**Shielding gas:** Ar-20%CO<sub>2</sub>

**Polarity:** DCEP

### Welding Positions:

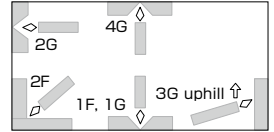

## Packaging data

φ mm	Spool	
	1.2	5kg
1.6	-	20kg
<b>Volume mm</b>	220W, 130H, 435L/4pcs	300W, 110H, 300L

## Composition (all-weld metal mass%)

	Typical	Guaranty <sup>a</sup>
<b>C</b>	0.06	0.12
<b>Si</b>	0.50	0.90
<b>Mn</b>	1.40	1.60
<b>P</b>	0.01	0.03
<b>S</b>	0.01	0.03
<b>Ni</b>	0.40	0.50
<b>Cr</b>	0.02	0.20
<b>Mo</b>	0.01	0.30
<b>V</b>	<0.01	0.08
<b>Cu</b>	0.02	0.35

Note: <sup>a</sup> Single values are maximum.

## Welding parameters (A)

φ mm	1F, 1G, 2F, 2G	3G uphill, 4G
1.2	100~250	120~250
1.6	150~340	180~280

## All-weld mechanical properties

	Typical		Guaranty
<b>0.2%YS (MPa)</b>	500	470	400min.
<b>TS (MPa)</b>	580	560	483~620
<b>El on 4d (%)</b>	30	31	22min.
<b>IV -46°C (J)</b>	100	60	27min.
<b>PWHT (°C×h)</b>	AW	620x3	AW

## Approvals

<b>ABS</b>	4Y400SA, H5
<b>CWB</b>	E491T-12MJ-H8

## Flux cored wire

**Features:** • Excellent impact values down to -60°C

**Classification:** AWS A5.29 E81T1-K2C

**Shielding gas:** CO<sub>2</sub>

**Polarity:** DCEP

## Welding Positions:

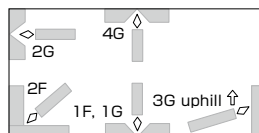

## Packaging data

φ mm	Spool		
1.2	12.5kg	15kg	20kg
1.4	-	15kg	-
<b>Volume mm</b>	300W, 110H, 300L		

## Composition (all-weld metal mass%)

	Typical	Guaranty <sup>a</sup>
<b>C</b>	0.04	0.15
<b>Si</b>	0.38	0.80
<b>Mn</b>	1.32	0.50~1.75
<b>P</b>	0.010	0.030
<b>S</b>	0.008	0.030
<b>Ni</b>	1.51	1.00~2.00
<b>Cr</b>	0.02	0.15
<b>Mo</b>	0.01	0.35
<b>V</b>	0.02	0.05

Note: <sup>a</sup>Single values are maximum.

## All-weld mechanical properties

	Typical	Guaranty
<b>0.2%YS (MPa)</b>	550	469min.
<b>TS (MPa)</b>	620	552~689
<b>EI on 4d (%)</b>	27	22min.
<b>IV -60°C (J)</b>	70	27min.

## Approvals

<b>ABS</b>	3YSA, 5Y400SA, MG, H5
<b>LR</b>	5Y40S, 5Y40M, H5
<b>DNV</b>	VY40MS (H5)
<b>BV</b>	SA5Y40M H5
<b>NK</b>	KSWL3G (C), KSWL3G (C) H5-TS540M, KSW54Y40G (C), H5
<b>KR</b>	L 3SG (C) H5, 5Y40SG (C) H5
<b>CCS</b>	5Y40S H5

## Welding parameters (A)

φ mm	1F, 1G	2F	2G	3G uphill, 4G
1.2	150~300	150~300	150~280	150~250
1.4	150~400	150~350	150~300	150~250



# DW-55LSR

## Flux cored wire

**Features:** ▪ Excellent impact value down to -60°C in the as-welded and PWHT conditions

**Classification:** AWS A5.29 E81T1-K2C

**Shielding gas:** CO<sub>2</sub>

**Polarity:** DCEP

### Welding Positions:

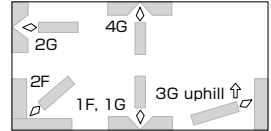

## Packaging data

φ mm	Spool		
	1.2	12.5kg	15kg
Volume mm	300W, 110H, 300L		

## Composition (all-weld metal mass%)

	Typical	Guaranty <sup>a</sup>
<b>C</b>	0.06	0.15
<b>Si</b>	0.29	0.80
<b>Mn</b>	1.21	0.50~1.75
<b>P</b>	0.008	0.030
<b>S</b>	0.007	0.030
<b>Ni</b>	1.56	1.00~2.00
<b>Cr</b>	0.01	0.15
<b>Mo</b>	0.01	0.35
<b>V</b>	<0.01	0.05

Note: <sup>a</sup>Single values are maximum.

## Welding parameters (A)

φ mm	1F, 1G, 2F	2G	3G uphill, 4G
1.2	150~300	150~280	150~250

## All-weld mechanical properties

	Typical		Guaranty
<b>0.2%YS (MPa)</b>	480	440	469min.
<b>TS (MPa)</b>	565	530	552~689
<b>EI on 4d (%)</b>	33	34	22min.
<b>IV -60°C (J)</b>	115	100	27min.
<b>PWHT (°Cxh)</b>	AW	620X1	AW

## Approvals

<b>ABS</b>	5YQ420SA (H5) 4Y400SA (H5)
<b>LR</b>	5Y42S, MG, H5
<b>DNV</b>	VY42MS (H5), MG VL2-4L, 4-4L
<b>BV</b>	SA4Y40M, UP, H5
<b>NK</b>	MG (KSW5Y42G (C) H5)

## Flux cored wire

- Features:**
- Excellent porosity resistibility to inorganic zinc primer
  - Excellent impact value down to -60°C

## Welding Positions:

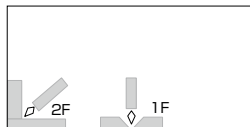

**Classification:** AWS A5.20 E70T-9C-J

**Shielding gas:** CO<sub>2</sub>

**Polarity:** DCEP

## Packaging data

φ mm	Spool		Drum
1.2	15kg	-	-
1.4	15kg	-	150kg
1.6	-	20kg	-
<b>Volume mm</b>	300W, 110H, 300L		530 φ, 820H

## Composition (all-weld metal mass%)

	Typical	Guaranty <sup>a</sup>
<b>C</b>	0.05	0.12
<b>Si</b>	0.44	0.90
<b>Mn</b>	1.42	1.75
<b>P</b>	0.01	0.03
<b>S</b>	0.01	0.03
<b>Ni</b>	0.34	0.50
<b>Cr</b>	0.03	0.20
<b>Mo</b>	0.01	0.30
<b>Cu</b>	0.02	0.35
<b>V</b>	0.01	0.08

Note: <sup>a</sup>Single values are maximum.

## Welding parameters (A)

φ mm	1F	2F
1.2	150~300	180~300
1.4	170~400	200~350
1.6	200~450	270~400

## All-weld mechanical properties

	Typical	Guaranty
<b>0.2%YS (MPa)</b>	540	400min.
<b>TS (MPa)</b>	590	483~655
<b>EI on 4d (%)</b>	29	22min.
<b>IV -60°C (J)</b>	58	27min.

## Approvals

	Single	Tandem
<b>ABS</b>	3YSA, MG	3YA, MG
<b>LR</b>	5Y40S H5	-
<b>DNV</b>	V YMS	-
<b>BV</b>	SA3YM, UP	A3YM, UP
<b>NK</b>	KSW54G (C), KSWL3G (C)	KAWL3MPG (C)

# DW-A55L

## Flux cored wire

**Features:**      ▪ Excellent impact values down to -60°C

**Classification:** AWS A5.29 E81T1-K2M

**Shielding gas:** Ar-20%CO<sub>2</sub>

**Polarity:**        DCEP

### Welding Positions:

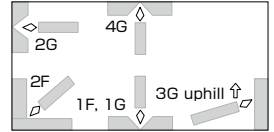

## Packaging data

φ mm	Spool
1.2	15kg
<b>Volume mm</b>	300W, 110H, 300L

## Composition (all-weld metal mass%)

	Typical	Guaranty <sup>a</sup>
<b>C</b>	0.06	0.15
<b>Si</b>	0.32	0.80
<b>Mn</b>	1.17	0.50~1.75
<b>P</b>	0.008	0.030
<b>S</b>	0.008	0.030
<b>Ni</b>	1.53	1.00~2.00
<b>Cr</b>	0.02	0.15
<b>Mo</b>	0.01	0.35
<b>V</b>	0.02	0.05

Note: <sup>a</sup> Single values are maximum.

## Welding parameters (A)

φ mm	1F, 1G, 2F	2G	3G uphill, 4G
1.2	150~300	150~280	150~250

## All-weld mechanical properties

	Typical	Guaranty
<b>0.2%YS (MPa)</b>	560	469min.
<b>TS (MPa)</b>	630	552~689
<b>EI on 4d (%)</b>	27	22min.
<b>IV -60°C (J)</b>	94	27min.

## Approvals

<b>ABS</b>	3YSA, MG
<b>LR</b>	5Y46S, H5
<b>DNV</b>	VY46MS (H5)
<b>BV</b>	SA5Y46 H5
<b>CCS</b>	5Y46SH5

## Flux cored wire

- Features:**
- Excellent impact value down to -60°C in the as-welded and PWHT conditions
  - Meets the NACE MR0175 requirements for both chemistry and hardness. The nickel content is normally 1% max.

**Classification:** AWS A5.29 E81T1-Ni1M

**Shielding gas:** Ar-20%CO<sub>2</sub>

**Polarity:** DCEP

### Welding Positions:

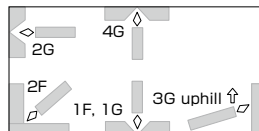

## Packaging data

φ mm	Spool
1.2	15kg
<b>Volume mm</b>	300W, 110H, 300L

## Composition (all-weld metal mass%)

	Typical	Guaranty <sup>a</sup>
<b>C</b>	0.07	0.12
<b>Si</b>	0.31	0.80
<b>Mn</b>	1.37	1.50
<b>P</b>	0.008	0.030
<b>S</b>	0.008	0.030
<b>Ni</b>	0.93	0.80~1.00
<b>Cr</b>	0.01	0.15
<b>Mo</b>	0.01	0.35
<b>V</b>	<0.01	0.05

Note: <sup>a</sup>Single values are maximum.

## Welding parameters (A)

φ mm	1F, 1G, 2F	2G	3G uphill, 4G
1.2	150~300	150~280	150~250

## All-weld mechanical properties

	Typical		Guaranty
<b>0.2%YS (MPa)</b>	510	450	469min.
<b>TS (MPa)</b>	570	530	552~689
<b>EI on 4d (%)</b>	29	33	22min.
<b>IV -60°C (J)</b>	120	70	27min.
<b>PWHT (°Cxh)</b>	AW	620x2	AW

## Approvals

<b>ABS</b>	5YQ420SA (H5)
<b>LR</b>	5Y42S (H5)
<b>DNV</b>	VY42MS (H5), MG, VL2-4L, 4-4L
<b>BV</b>	SA5Y42 H5
<b>CCS</b>	5Y42S, H5

# DW-A81Ni1

## Flux cored wire

- Features:**
- Excellent impact values down to -60°C
  - Meets the NACE MR0175 requirements for both chemistry and hardness. The nickel content is normally 1% max.

**Classification:** AWS A5.29 E81T1-Ni1M-J

**Shielding gas:** Ar-20%CO<sub>2</sub>

**Polarity:** DCEP

## Welding Positions:

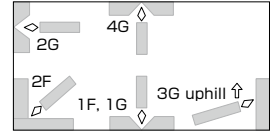

## Packaging data

φ mm	Spool
1.2	15kg
<b>Volume mm</b>	300W, 110H, 300L

## Composition (all-weld metal mass%)

	Typical	Guaranty <sup>a</sup>
<b>C</b>	0.06	0.12
<b>Si</b>	0.35	0.80
<b>Mn</b>	1.30	1.50
<b>P</b>	0.009	0.030
<b>S</b>	0.008	0.030
<b>Ni</b>	0.91	0.80~1.00
<b>Cr</b>	0.02	0.15
<b>Mo</b>	0.01	0.35
<b>V</b>	0.02	0.05

Note: <sup>a</sup> Single values are maximum.

## Welding parameters (A)

φ mm	1F, 1G, 2F	2G	3G uphill, 4G
1.2	150~300	150~280	150~250

## All-weld mechanical properties

	Typical	Guaranty
<b>0.2%YS (MPa)</b>	520	469min.
<b>TS (MPa)</b>	580	552~689
<b>EI on 4d (%)</b>	29	19min.
<b>IV -60°C (J)</b>	142	27min.

## Approvals

<b>ABS</b>	5YQ420SA (H5) 4Y400SA (H5), MG
<b>LR</b>	5Y42S, H5
<b>DNV</b>	VY42MS (H5)
<b>CWB</b>	E551T1-Ni1MJ-H8 (E81T1-Ni1MJ-H8)

# DW-A65Ni1

## Flux cored wire

- Features:**
- Suitable for welding up to X70 grade pipe
  - Excellent impact value down to -50°C
  - The nickel content is normally 1% max.

**Classification:** AWS A5.29 E91T-GM

**Shielding gas:** Ar-20%CO<sub>2</sub>

**Polarity:** DCEP

### Welding Positions:

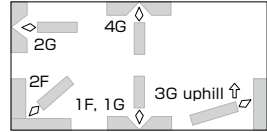

## Packaging data

φ mm	Spool	
	5kg	15kg
1.2		
<b>Volume mm</b>	220W, 130H, 435L/4pcs	300W, 110H, 300L

## Composition (all-weld metal mass%)

	Typical	Guaranty <sup>a</sup>
<b>C</b>	0.05	0.03~0.10
<b>Si</b>	0.33	0.90
<b>Mn</b>	1.51	1.40~2.00
<b>P</b>	0.009	0.020
<b>S</b>	0.008	0.020
<b>Ni</b>	0.95	0.60~1.00
<b>Cr</b>	0.02	0.20
<b>Mo</b>	0.16	0.20
<b>V</b>	<0.01	0.05

Note: <sup>a</sup>Single values are maximum.

## Welding parameters (A)

φ mm	1F, 1G, 2F	2G	3G uphill, 4G
1.2	150~300	150~280	150~250

## All-weld mechanical properties

	Typical	Guaranty
<b>0.2%YS (MPa)</b>	610	538min.
<b>TS (MPa)</b>	670	621~758
<b>EI on 4d (%)</b>	23	17min.
<b>IV -50°C (J)</b>	84	27min.

## Approvals

<b>LR</b>	4Y50SH5
<b>DNV</b>	IVY50MSH5

# DW-62L

## Flux cored wire

- Features:**
- Excellent impact value down to -60°C
  - Excellent CTOD value down to -40°C

**Classification:** AWS A5.29 E91T1-Ni2C-J

**Shielding gas:** CO<sub>2</sub>

**Polarity:** DCEP

### Welding Positions:

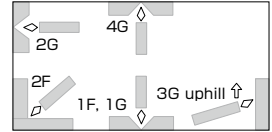

## Packaging data

φ mm	Spool	
	1.2	12.5kg
Volume mm	300W, 110H, 300L	

## Composition (all-weld metal mass%)

	Typical	Guaranty <sup>a</sup>
<b>C</b>	0.08	0.12
<b>Si</b>	0.30	0.80
<b>Mn</b>	1.37	1.50
<b>P</b>	0.008	0.030
<b>S</b>	0.010	0.030
<b>Ni</b>	2.57	1.75~2.75

Note: <sup>a</sup>Single values are maximum.

## Welding parameters (A)

φ mm	1F, 1G, 2F	2G	3G uphill, 4G
1.2	150~300	150~280	150~250

## All-weld mechanical properties

	Typical	Guaranty
<b>0.2%YS (MPa)</b>	580	538min.
<b>TS (MPa)</b>	650	621~758
<b>El on 4d (%)</b>	25	17min.
<b>IV -60°C (J)</b>	93	27min.

## Approvals

<b>ABS</b>	5YQ500 H5
<b>LR</b>	5Y50S, H5
<b>DNV</b>	VY50MS (H5)
<b>BV</b>	SA5Y50M H5
<b>NK</b>	KSW5Y50G (C) H5
<b>RS</b>	5Y50 MS H5

## Flux cored wire

- Features:**
- Excellent impact value down to -60°C
  - Excellent CTOD value down to -40°C

**Classification:** AWS A5.29 E91T1-Ni2M-J

**Shielding gas:** Ar-20%CO<sub>2</sub>

**Polarity:** DCEP

### Welding Positions:

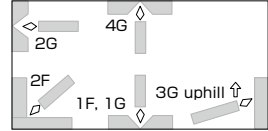

### Packaging data

φ mm	Spool	
	1.2	12.5kg
<b>Volume mm</b>	300W, 110H, 300L	

### Composition (all-weld metal mass%)

	Typical	Guaranty <sup>a</sup>
<b>C</b>	0.07	0.12
<b>Si</b>	0.30	0.80
<b>Mn</b>	1.38	1.50
<b>P</b>	0.008	0.030
<b>S</b>	0.009	0.030
<b>Ni</b>	2.13	1.75~2.75

Note: <sup>a</sup> Single values are maximum.

### Welding parameters (A)

φ mm	1F, 1G, 2F	2G	3G uphill, 4G
1.2	150~300	150~280	150~250

### All-weld Mechanical properties

	Typical	Guaranty
<b>0.2%YS (MPa)</b>	560	538min.
<b>TS (MPa)</b>	640	621~758
<b>EI on 4d (%)</b>	27	17min.
<b>IV -60°C (J)</b>	82	27min.

### Approvals

<b>ABS</b>	5YQ500SA H5
<b>LR</b>	5Y50S, H5
<b>DNV</b>	VY50MS (H5)



# DW-A62LSR

## Flux cored wire

**Features:** ▪ Excellent impact value down to -60°C in the as-welded condition and -40°C in PWHT condition

**Classification:** AWS A5.29 E91T1-GM

**Shielding gas:** Ar-20%CO<sub>2</sub>

**Polarity:** DCEP

### Welding Positions:

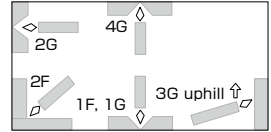

## Packaging data

φ mm	Spool
1.2	12.5kg
<b>Volume mm</b>	300W, 110H, 300L

## Composition (all-weld metal mass%)

	Typical	Guaranty <sup>a</sup>
<b>C</b>	0.05	0.15
<b>Si</b>	0.15	0.80
<b>Mn</b>	1.30	1.00~1.75
<b>P</b>	0.007	0.030
<b>S</b>	0.008	0.030
<b>Ni</b>	2.59	2.00~2.75
<b>Cr</b>	0.02	0.15
<b>Mo</b>	0.20	0.35
<b>V</b>	<0.01	0.05

Note: <sup>a</sup> Single values are maximum.

## Welding parameters (A)

φ mm	1F, 1G, 2F	2G	3G uphill, 4G
1.2	150~300	150~280	150~250

## All-weld mechanical properties

	Typical		Guaranty
<b>0.2%YS (MPa)</b>	610	595	538min.
<b>TS (MPa)</b>	675	660	621~758
<b>El on 4d (%)</b>	23	24	17min.
<b>IV (J)</b>	-60°C:98	-40°C:92	27min.
<b>PWHT (°C×h)</b>	AW	620x2	AW

## Flux cored wire

- Features:**
- Suitable with a short circuit arc
  - Excellent impact value down to -60°C

**Classification:** AWS A5.28 E80C-G

**Shielding gas:** Ar-20%CO<sub>2</sub>

**Polarity:** DCEP

### Welding Positions:

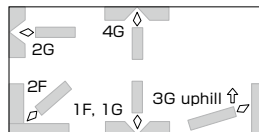

### Packaging data

φ mm	Spool
1.2	15kg
<b>Volume mm</b>	300W, 110H, 300L

### Composition (all-weld metal mass%)

	Typical	Guaranty <sup>a</sup>
<b>C</b>	0.05	0.15
<b>Si</b>	0.40	0.80
<b>Mn</b>	1.40	0.50~1.75
<b>P</b>	0.010	0.030
<b>S</b>	0.014	0.030
<b>Ni</b>	1.42	1.00~2.00
<b>Cr</b>	0.02	0.15
<b>Mo</b>	0.01	0.20
<b>V</b>	0.01	0.05
<b>Cu</b>	0.04	0.30

Note: <sup>a</sup>Single values are maximum.

### Welding parameters (A)

φ mm	1F, 1G, 2F, 2G	3G uphill, 4G
1.2	50~300	50~180

### All-weld mechanical properties

	Typical	Guaranty
<b>0.2%YS (MPa)</b>	540	469min.
<b>TS (MPa)</b>	600	552~689
<b>EI on 4d (%)</b>	29	19min.
<b>IV -60°C (J)</b>	90	27min.

### Approvals

<b>LR</b>	5Y40S, H5
<b>DNV</b>	VYMS (H5)
<b>BV</b>	SA3YM H5, UP

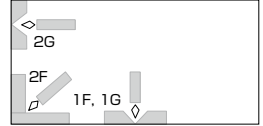
**MX-A55Ni1****Flux cored wire****Features:** ▪ Excellent impact values down to -60°C**Classification:** AWS A5.28 E80C-G**Shielding gas:** Ar-20%CO<sub>2</sub>**Polarity:** DCEP**Welding Positions:****Packaging data**

$\phi$ mm	Spool
1.2	15kg
<b>Volume mm</b>	300W, 110H, 300L

**Composition (all-weld metal mass%)**

	Typical	Guaranty <sup>a</sup>
<b>C</b>	0.05	0.15
<b>Si</b>	0.34	0.80
<b>Mn</b>	1.67	1.40~2.00
<b>P</b>	0.007	0.030
<b>S</b>	0.008	0.030
<b>Ni</b>	0.86	0.70~1.00
<b>Cr</b>	0.02	0.15
<b>Mo</b>	0.01	0.20
<b>V</b>	<0.01	0.05
<b>Cu</b>	0.03	0.30

**Welding parameters (A)**

$\phi$ mm	1F, 1G, 2F	2G
1.2	150~300	150~300

Note: <sup>a</sup> Single values are maximum.**All-weld mechanical properties**

	Typical	Guaranty
<b>0.2%YS (MPa)</b>	540	470min.
<b>TS (MPa)</b>	610	552~680
<b>El on 4d (%)</b>	29	20min.
<b>IV -60°C (J)</b>	120	27min.

## Flux cored wire

**Features:** • Excellent impact values down to -60°C

**Classification:** AWS A5.28 E110C-G H4

**Shielding gas:** Ar-20%CO<sub>2</sub>

**Polarity:** DCEP

## Welding Positions:

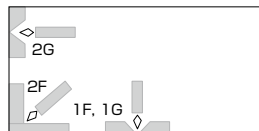

## Packaging data

φ mm	Spool
1.2	12.5kg
Volume mm	300W, 110H, 300L

## Composition (all-weld metal mass%)

	Typical	Guaranty <sup>a</sup>
<b>C</b>	0.06	0.03~0.10
<b>Si</b>	0.48	0.90
<b>Mn</b>	1.87	1.1~2.0
<b>P</b>	0.009	0.020
<b>S</b>	0.009	0.020
<b>Ni</b>	2.49	2.1~3.0
<b>Cr</b>	0.01	0.2
<b>Mo</b>	0.09	0.2
<b>V</b>	<0.01	0.05
<b>Nb</b>	<0.01	0.05

Note: <sup>a</sup>Single values are maximum.

## Welding parameters (A)

φ mm	1F, 1G, 2F	2G
1.2	150~300	150~300

## All-weld mechanical properties

	Typical	Guaranty
<b>0.2%YS (MPa)</b>	720	676min.
<b>TS (MPa)</b>	800	759~896
<b>EI on 4d (%)</b>	24	15min.
<b>IV -60°C (J)</b>	120	47min.

## Approvals

<b>ABS</b>	5YQ690SA (H5)
<b>LR</b>	5Y69S, H5
<b>DNV</b>	VY69MS (H5)

# DW-50LSR

## Flux cored wire

- Features:**
- Excellent impact values down to -60°C and down to -50°C in the PWHT condition
  - Meets the NACE MR0175 requirements for both chemistry and hardness. The nickel content is normally 1% max.

**Classification:** AWS A5.29 E71T1-GC

**Shielding gas:** CO<sub>2</sub>

**Polarity:** DCEP

### Welding Positions:

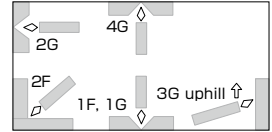

### Packaging data

φ mm	Spool	
	1.2	12.5kg
<b>Volume mm</b>	300W, 110H, 300L	

### Composition (all-weld metal mass%)

	Typical	Guaranty <sup>a</sup>
<b>C</b>	0.06	0.12
<b>Si</b>	0.29	1.00
<b>Mn</b>	1.34	0.50~1.75
<b>P</b>	0.009	0.030
<b>S</b>	0.007	0.030
<b>Ni</b>	0.88	0.70~1.00
<b>Cr</b>	0.01	0.15
<b>Mo</b>	0.01	0.35
<b>V</b>	<0.01	0.05

Note: <sup>a</sup> Single values are maximum.

### Welding parameters (A)

φ mm	1F, 1G, 2F	2G	3G uphill, 4G
1.2	150~300	150~280	150~250

### All-weld mechanical properties

	Typical		Guaranty
	<b>0.2%YS (MPa)</b>	480	
<b>TS (MPa)</b>	560	520	483~655
<b>EI on 4d (%)</b>	31	35	20min.
<b>IV -60°C (J)</b>	110	110	27min.
<b>PWHT (°C×h)</b>	AW	620x1	AW

### Approvals

<b>ABS</b>	5Y400SA, H5
<b>LR</b>	5Y40S, H5
<b>DNV</b>	VY40MS (H5)
<b>RS</b>	5Y40SM H5

## Flux cored wire

- Features:**
- Suitable for welding up to X80 grade pipe
  - Excellent impact value down to -50°C
  - The nickel content is normally 1% max.

**Classification:** AWS A5.29 E101T1-GM

**Shielding gas:** Ar-20%CO<sub>2</sub>

**Polarity:** DCEP

## Welding Positions:

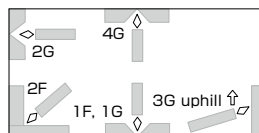

## Packaging data

φ mm	Spool	
	5kg	15kg
1.2		
<b>Volume mm</b>	220W, 130H, 435L/4pcs	300W, 110H, 300L

## Composition (all-weld metal mass%)

	Typical	Guaranty <sup>a</sup>
<b>C</b>	0.05	0.15
<b>Si</b>	0.36	0.80
<b>Mn</b>	1.90	1.00~2.00
<b>P</b>	0.005	0.030
<b>S</b>	0.008	0.030
<b>Ni</b>	0.89	0.40~1.00
<b>Cr</b>	0.02	0.20
<b>Mo</b>	0.42	0.30~0.70
<b>V</b>	<0.01	0.05

Note: <sup>a</sup>Single values are maximum.

## Welding parameters (A)

φ mm	1F, 1G, 2F	2G	3G uphill, 4G
1.2	150~300	150~280	150~250

## All-weld mechanical properties

	Typical	Guaranty
<b>0.2%YS (MPa)</b>	660	607min.
<b>TS (MPa)</b>	740	690~827
<b>EI on 4d (%)</b>	21	16min.
<b>IV -50°C (J)</b>	70	27min.

## Approvals

<b>LR</b>	4Y62S H5
<b>DNV</b>	IVY62MS H5

# DW-A80L

## Flux cored wire

**Features:** ▪ Excellent impact value down to -40°C

**Classification:** AWS A5.29 E111T1-GM-H4

**Shielding gas:** Ar-20%CO<sub>2</sub>

**Polarity:** DCEP

### Welding Positions:

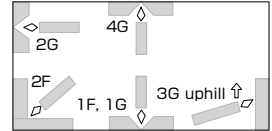

### Packaging data

φ mm	Spool	
	1.2	5kg
<b>Volume mm</b>	220W, 130H, 435L/4pcs	300W, 110H, 300L

### Composition (all-weld metal mass%)

	Typical	Guaranty <sup>a</sup>
<b>C</b>	0.07	0.12
<b>Si</b>	0.31	0.80
<b>Mn</b>	1.86	1.25~2.25
<b>P</b>	0.007	0.030
<b>S</b>	0.006	0.030
<b>Ni</b>	2.49	1.75~2.75
<b>Cr</b>	0.02	0.20
<b>Mo</b>	0.16	0.50
<b>Cu</b>	0.01	0.50

Note: <sup>a</sup> Single values are maximum.

### Welding parameters (A)

φ mm	1F, 1G, 2F	2G	3G uphill, 4G
1.2	150~300	150~280	150~250

### All-weld mechanical properties

	Typical	Guaranty
<b>0.2%YS (MPa)</b>	760	676min.
<b>TS (MPa)</b>	810	759~896
<b>El on 4d (%)</b>	21	15min.
<b>IV -40°C (J)</b>	90	27min.

### Approvals

<b>ABS</b>	4YQ690SA H5, MG
<b>LR</b>	4Y69S H5
<b>DNV</b>	IVY69MS, MG (H5)
<b>NK</b>	KSW4Y69G (M2) H5

# DW-460L

## Flux cored wire

- Features:**
- Suitable for YP47 grade hull structural steel plates
  - Excellent impact value down to -60°C

**Classification:** AWS -

**Shielding gas:** CO<sub>2</sub>

**Polarity:** DCEP

### Welding Positions:

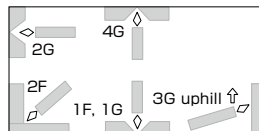

## Packaging data

φ mm	Spool	
	1.2	12.5kg
Volume mm	300W, 110H, 300L	

## Composition (all-weld metal mass%)

	Typical	Guaranty <sup>a</sup>
<b>C</b>	0.04	0.15
<b>Si</b>	0.43	0.80
<b>Mn</b>	1.53	0.50~1.75
<b>P</b>	0.009	0.030
<b>S</b>	0.007	0.030
<b>Ni</b>	1.56	1.00~2.00

Note: <sup>a</sup> Single values are maximum.

## Welding parameters (A)

φ mm	1F,1G, 2F	2G	3G uphill, 4G
1.2	150~300	150~280	150~250

## All-weld mechanical properties

	Typical	Guaranty
<b>0.2%YS (MPa)</b>	580	460min.
<b>TS (MPa)</b>	650	570~720
<b>EI on 4d (%)</b>	25	20min.
<b>IV -20°C (J)</b>	140	57min.

## Approvals

<b>ABS</b>	5YQ460H5
<b>LR</b>	5Y46S, 3Y47S H5
<b>DNV</b>	VY46MSH5
<b>BV</b>	SA3Y47MH5, SA5Y46MH5
<b>NK</b>	KSW5Y46G (C) H5, KSW63Y47G (C) H5
<b>KR</b>	5Y46SMG (C1), H5
<b>CCS</b>	For YP47 Steel Plate



## Solid wire

**Features:** • Suitable for 400 to 490MPa tensile strength steel

**Classification:** AWS A5.18 ER70S-G

**Shielding gas:** Ar-20%CO<sub>2</sub>

**Polarity:** DCEP

## Welding Positions:

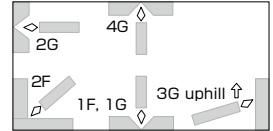

## Packaging data

φ mm	Spool
1.2	20kg
<b>Volume mm</b>	280W, 110H, 270L

## Composition (wire mass%)

	Typical	Guaranty <sup>a</sup>
<b>C</b>	0.07	0.03~0.10
<b>Si</b>	0.40	0.30~0.50
<b>Mn</b>	1.91	1.50~2.10
<b>P</b>	0.006	0.015
<b>S</b>	0.002	0.015
<b>Cu</b>	0.21	0.40
<b>Ti</b>	0.08	0.04~0.12
<b>B</b>	0.006	0.003~0.010

Note: <sup>a</sup> Single values are maximum.

## Welding parameters (A)

φ mm	1F, 1G, 2F, 2G	3G uphill, 4G
1.2	80~300	50~180

## All-weld mechanical properties

	Typical		Guaranty
<b>0.2%YS (MPa)</b>	470	440	400min.
<b>TS (MPa)</b>	540	510	483min.
<b>EI on 4d (%)</b>	33	35	22min.
<b>IV -60°C (J)</b>	110	88	27min.
<b>PWHT (°Cxh)</b>	AW	620x1	AW & 620±15x1

## Approvals

<b>ABS</b>	3YSA, MG
<b>LR</b>	5Y40S (H15)
<b>DNV</b>	VYMS, VL2-4L, 4-4L
<b>NK</b>	KSWL3G (M2)

## Solid wire

**Features:** • Suitable for low temperature steel

**Classification:** AWS A5.28 ER70S-G

**Shielding gas:** Ar-5~20%CO<sub>2</sub>

**Polarity:** DCEP

## Welding Positions:

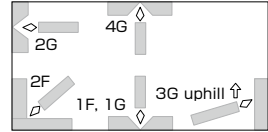

## Packaging data

φ mm	Spool
1.2	20kg
<b>Volume mm</b>	280W, 110H, 270L

## Composition (wire mass%)

	Typical	Guaranty <sup>a</sup>
<b>C</b>	0.04	0.07
<b>Si</b>	0.43	0.20~0.60
<b>Mn</b>	1.37	1.00~1.60
<b>P</b>	0.003	0.020
<b>S</b>	0.008	0.020
<b>Ni</b>	1.76	1.50~2.00
<b>Mo</b>	0.20	0.40
<b>Cu</b>	0.21	0.50

## Welding parameters (A)

φ mm	1F, 1G, 2F, 2G	3G uphill, 4G
1.2	80~300	50~180

Note: <sup>a</sup> Single values are maximum.

## All-weld mechanical properties

	Typical	Guaranty
<b>0.2%YS (MPa)</b>	410	360min.
<b>TS (MPa)</b>	520	483min.
<b>EI on 4d (%)</b>	32	22min.
<b>IV -60°C (J)</b>	140	27min.
<b>PWHT (°C×h)</b>	620x1	620±15x1
<b>SG</b>	Ar-20%CO <sub>2</sub>	Ar-20%CO <sub>2</sub>

## Solid wire

**Features:**      ▪ Suitable for 3.5% Ni steel

**Classification:** AWS A5.28 ER70S-G

**Shielding gas:** Ar-5~20%CO<sub>2</sub>

**Polarity:**        DCEP

## Welding Positions:

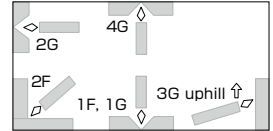

## Packaging data

φ mm	Spool
1.2	20kg
<b>Volume mm</b>	280W, 110H, 270L

## Composition (wire mass%)

	Typical	Guaranty <sup>a</sup>
<b>C</b>	0.02	0.07
<b>Si</b>	0.29	0.50
<b>Mn</b>	1.24	1.00~1.50
<b>P</b>	0.006	0.020
<b>S</b>	0.002	0.020
<b>Ni</b>	4.16	3.80~4.50
<b>Mo</b>	0.21	0.40
<b>Cu</b>	0.22	0.50

## Welding parameters (A)

φ mm	1F, 1G, 2F, 2G	3G uphill, 4G
1.2	80~300	50~180

Note: <sup>a</sup> Single values are maximum.

## All-weld mechanical properties

	Typical	Guaranty
<b>0.2%YS (MPa)</b>	470	360min.
<b>TS (MPa)</b>	570	483min.
<b>EI on 4d (%)</b>	32	16min.
<b>IV (J)</b>	-101°C: 130	-105°C: 27min.
<b>PWHT (°Cxh)</b>	620x1	620±15x1
<b>SG</b>	Ar-5%CO <sub>2</sub>	Ar-5%CO <sub>2</sub>

## Solid wire

**Features:** • Suitable for flat, horizontal and horizontal fillet welding

**Classification:** -

**Shielding gas:** CO<sub>2</sub>

**Polarity:** DCEP

## Welding Positions:

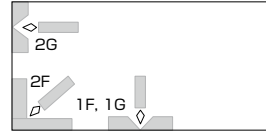

## Packaging data

φ mm	Spool
0.9	20kg
1.2	20kg
1.4	20kg
1.6	20kg
<b>Volume mm</b>	280W, 110H, 270L

## Composition (wire mass%)

	Typical	Guaranty <sup>a</sup>
<b>C</b>	0.04	0.12
<b>Si</b>	0.82	0.60~1.00
<b>Mn</b>	1.95	1.40~2.10
<b>P</b>	0.013	0.025
<b>S</b>	0.010	0.025
<b>Mo</b>	0.35	0.10~0.45
<b>Cu</b>	0.25	0.50
<b>Ti</b>	0.20	0.02~0.30

Note: <sup>a</sup> Single values are maximum.

## Welding parameters (A)

φ mm	1F, 1G, 2F	2G
0.9	50~200	50~180
1.2	100~350	100~300
1.4	150~450	150~350
1.6	200~550	200~400

## All-weld mechanical properties

	Typical		Guaranty
<b>0.2%YS (MPa)</b>	590	570	500min.
<b>TS (MPa)</b>	670	660	552min.
<b>EI on 4d (%)</b>	28	29	19min.
<b>IV -18°C (J)</b>	90	80	-5°C: 47min.
<b>PWHT (°C×h)</b>	AW	620x5	AW

## Approvals

<b>ABS</b>	3YQ500
<b>DNV</b>	Ⅲ Y46MS, MG
<b>NK</b>	KSW3Y50G (C) H5

## Solid wire

**Features:**     ▪ Suitable for 550 to 610MPa tensile strength steel

**Classification:** AWS A5.28 ER90S-G

**Shielding gas:** Ar-5~25%CO<sub>2</sub>

**Polarity:**       DCEP

## Welding Positions:

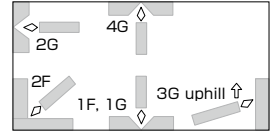

## Packaging data

φ mm	Spool
1.2	20kg
<b>Volume mm</b>	280W, 110H, 270L

## Composition (wire mass%)

	Typical	Guaranty <sup>a</sup>
<b>C</b>	0.06	0.02~0.15
<b>Si</b>	0.71	0.50~0.90
<b>Mn</b>	1.36	1.10~1.60
<b>P</b>	0.006	0.025
<b>S</b>	0.012	0.025
<b>Cr</b>	0.45	0.30~0.60
<b>Mo</b>	0.28	0.10~0.45
<b>Cu</b>	0.25	0.40
<b>Ti</b>	0.08	0.02~0.30

Note: <sup>a</sup> Single values are maximum.

## Welding parameters (A)

φ mm	1F, 1G, 2F	2G	3G uphill, 4G
1.2	80~350	80~300	50~160

## All-weld mechanical properties

	Typical	Guaranty
<b>0.2%YS (MPa)</b>	580	500min.
<b>TS (MPa)</b>	660	621min.
<b>El on 4d (%)</b>	29	19min.
<b>IV -18°C (J)</b>	150	-5°C: 47min.
<b>SG</b>	Ar-20%CO <sub>2</sub>	Ar-20%CO <sub>2</sub>

## Solid wire

**Features:** • Suitable for 690MPa tensile strength steel

**Classification:** AWS A5.28 ER100S-G

**Shielding gas:** CO<sub>2</sub>

**Polarity:** DCEP

## Welding Positions:

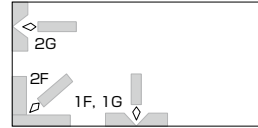

## Packaging data

$\phi$ mm	Spool
1.2	20kg
1.6	20kg
<b>Volume mm</b>	280W, 110H, 270L

## Composition (wire mass%)

	Typical	Guaranty <sup>a</sup>
<b>C</b>	0.06	0.12
<b>Si</b>	0.78	0.50~1.00
<b>Mn</b>	2.00	1.70~2.30
<b>P</b>	0.011	0.030
<b>S</b>	0.007	0.030
<b>Ni</b>	1.05	0.70~1.50
<b>Mo</b>	0.64	0.40~0.90
<b>Cu</b>	0.23	0.35

## Welding parameters (A)

$\phi$ mm	1F, 1G, 2F, 2G
1.2	100~300
1.6	200~450

Note: <sup>a</sup>Single values are maximum.

## All-weld mechanical properties

	Typical	Guaranty
<b>0.2%YS (MPa)</b>	610	550min.
<b>TS (MPa)</b>	720	690min.
<b>EI on 4d (%)</b>	26	16min.
<b>IV -18°C (J)</b>	90	27min.

## Solid wire

**Features:**      ▪ Suitable for 690MPa tensile strength steel

**Classification:** AWS A5.28 ER100S-G

**Shielding gas:** Ar-5~25%CO<sub>2</sub>

**Polarity:**        DCEP

## Welding Positions:

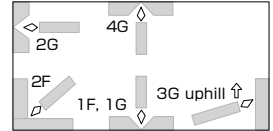

## Packaging data

φ mm	Spool
1.2	20kg
<b>Volume mm</b>	280W, 110H, 270L

## Composition (wire mass%)

	Typical	Guaranty <sup>a</sup>
<b>C</b>	0.06	0.11
<b>Si</b>	0.47	0.30~0.80
<b>Mn</b>	1.41	0.90~1.60
<b>P</b>	0.010	0.030
<b>S</b>	0.008	0.030
<b>Ni</b>	2.02	1.50~2.50
<b>Cr</b>	0.17	0.30
<b>Mo</b>	0.39	0.20~0.60
<b>Cu</b>	0.21	0.50

Note: <sup>a</sup> Single values are maximum.

## Welding parameters (A)

φ mm	1F, 1G, 2F, 2G	3G uphill, 4G
1.2	80~300	50~180

## All-weld mechanical properties

	Typical	Guaranty
<b>0.2%YS (MPa)</b>	650	550min.
<b>TS (MPa)</b>	720	690min.
<b>EI on 4d (%)</b>	25	16min.
<b>IV -40°C (J)</b>	100	27min.
<b>SG</b>	Ar-20%CO <sub>2</sub>	Ar-20%CO <sub>2</sub>

## Solid wire

**Features:** • Suitable for 780MPa tensile strength steel

**Classification:** AWS A5.28 ER110S-G

**Shielding gas:** CO<sub>2</sub>

**Polarity:** DCEP

## Welding Positions:

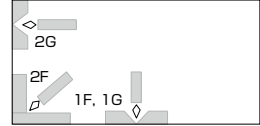

## Packaging data

φ mm	Spool
1.2	20kg
<b>Volume mm</b>	300W, 110H, 300L

## Composition (wire mass%)

	Typical	Guaranty <sup>a</sup>
<b>C</b>	0.07	0.12
<b>Si</b>	0.67	0.40~0.90
<b>Mn</b>	1.78	1.60~2.20
<b>P</b>	0.009	0.025
<b>S</b>	0.008	0.025
<b>Ni</b>	2.16	1.80~2.60
<b>Mo</b>	0.62	0.40~0.90
<b>Cu</b>	0.23	0.35

Note: <sup>a</sup> Single values are maximum.

## Welding parameters (A)

φ mm	1F, 1G, 2F, 2G
1.2	100~300

## All-weld mechanical properties

	Typical	Guaranty
<b>0.2%YS (MPa)</b>	710	590min.
<b>TS (MPa)</b>	830	759min.
<b>EI on 4d (%)</b>	24	15min.
<b>IV -18°C (J)</b>	85	27min.



## Solid wire

**Features:**      • Suitable for 780MPa tensile strength steel

**Classification:** AWS A5.28 ER110S-G

**Shielding gas:** Ar-5~25%CO<sub>2</sub>

**Polarity:**        DCEP

## Welding Positions:

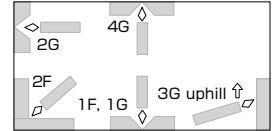

## Packaging data

φ mm	Spool
1.2	20kg
<b>Volume mm</b>	300W, 110H, 300L

## Composition (wire mass%)

	Typical	Guaranty <sup>a</sup>
<b>C</b>	0.05	0.12
<b>Si</b>	0.51	0.20~0.70
<b>Mn</b>	1.37	1.10~1.70
<b>P</b>	0.011	0.025
<b>S</b>	0.002	0.025
<b>Ni</b>	2.64	2.40~2.90
<b>Cr</b>	0.16	0.05~0.35
<b>Mo</b>	0.47	0.35~0.70
<b>Ti</b>	0.11	0.02~0.30
<b>Cu</b>	0.22	0.50

Note: <sup>a</sup>Single values are maximum.

## Welding parameters (A)

φ mm	1F, 1G, 2F, 2G	3G uphill, 4G
1.2	80~300	50~180

## All-weld mechanical properties

	Typical	Guaranty
<b>0.2%YS (MPa)</b>	770	665min.
<b>TS (MPa)</b>	850	759min.
<b>EI on 4d (%)</b>	20	15min.
<b>IV -40°C (J)</b>	80	27min.
<b>SG</b>	Ar-20%CO <sub>2</sub>	Ar-20%CO <sub>2</sub>

## Approvals

<b>ABS</b>	MG
<b>DNV</b>	IVY69MS
<b>NK</b>	KSW4Y69G (M2)

**Solid wire**

**Features:** • Suitable for 780MPa tensile strength steel for low temperature service

**Classification:** AWS A5.28 ER120S-G

**Shielding gas:** Ar-20%CO<sub>2</sub>

**Polarity:** DCEP

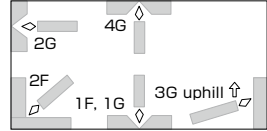
**Welding Positions:****Packaging data**

φ mm	Spool	
	1.2	10kg
Volume mm	240W, 110H, 230L	280W, 110H, 270L

**Composition (wire mass%)**

	Typical	Guaranty <sup>a</sup>
<b>C</b>	0.06	0.09
<b>Si</b>	0.50	0.30~0.70
<b>Mn</b>	1.48	1.30~1.70
<b>P</b>	0.004	0.020
<b>S</b>	0.002	0.020
<b>Ni</b>	3.51	3.20~3.80
<b>Mo</b>	0.76	0.60~0.90
<b>Cu</b>	0.23	0.50

Note: <sup>a</sup> Single values are maximum.

**Welding parameters (A)**

φ mm	1F, 1G, 2F, 2G	3G uphill, 4G
1.2	80~300	50~180

**All-weld mechanical properties**

	Typical	Guaranty
<b>0.2%YS (MPa)</b>	770	690min.
<b>TS (MPa)</b>	880	828min.
<b>EI on 4d (%)</b>	22	15min.
<b>IV (J)</b>	-80°C: 78	-60°C: 27min.

**Approvals**

<b>ABS</b>	4AQ690SAH5, MG
<b>LR</b>	4Y69S H5, MG
<b>DNV</b>	IVY69MS (H5), MG
<b>BV</b>	SA4Y69M H5, MG
<b>NK</b>	KSW4Y69G (M2) H5
<b>CCS</b>	4Y69H5, MG

## TIG welding rod and wire

<b>Features:</b>	▪ Suitable for low temperature steel
<b>Classification:</b>	AWS A5.28 ER70S-G
<b>Shielding gas:</b>	Ar
<b>Identification color:</b>	1st Black
<b>Polarity:</b>	DCEN

## Packaging data

φ mm	Spool		Tube	
	kg	kg	Length mm	g/piece
1.2	10	-	-	-
1.6	-	5	1,000	16
2.0	-	5	1,000	25
2.4	-	5	1,000	35
3.2	-	5	1,000	63
<b>Volume mm</b>	240W, 110H, 230L		40W, 35H, 1015L	

## Composition (wire mass%)

	Typical	Guaranty <sup>a</sup>
<b>C</b>	0.05	0.09
<b>Si</b>	0.31	0.60
<b>Mn</b>	1.07	0.70~1.30
<b>P</b>	0.005	0.025
<b>S</b>	0.007	0.025
<b>Ni</b>	0.79	0.60~1.00
<b>Mo</b>	0.15	0.30
<b>Cu</b>	0.15	0.40

Note: <sup>a</sup> Single values are maximum.

## Welding parameters (A)

φ mm	Wire	Rod
1.2	50~280	-
1.6	-	60~220
2.0	-	80~240
2.4	-	100~260
3.2	-	150~300

## All-weld mechanical properties

	Typical		Guaranty
	<b>0.2%YS (MPa)</b>	460	390
<b>TS (MPa)</b>	540	450	483min.
<b>EI on 4d (%)</b>	33	35	24min.
<b>IV -60°C (J)</b>	200	250	27min.
<b>PWHT (°C×h)</b>	AW	620x1	AW

## Approvals

<b>ABS</b>	4YSA, MG
<b>LR</b>	MG
<b>DNV</b>	VYM, VL4-4L
<b>BV</b>	4YM, UP
<b>NK</b>	KSWL2G (I)

## TIG welding rod and wire

<b>Features:</b>	▪ Suitable for 3.5% Ni steel
<b>Classification:</b>	AWS A5.28 ER70S-G
<b>Shielding gas:</b>	Ar
<b>Identification color:</b>	1st Yellowish green
<b>Polarity:</b>	DCEN

## Packaging data

φ mm	Spool		Tube	
	kg	kg	Length mm	g/piece
1.2	10	-	-	-
1.6	-	5	1,000	16
2.0	-	5	1,000	25
2.4	-	5	1,000	35
3.2	-	5	1,000	63
<b>Volume mm</b>	240W, 110H, 230L		40W, 35H, 1015L	

## Composition (wire mass%)

	Typical	Guaranty <sup>a</sup>
<b>C</b>	0.02	0.06
<b>Si</b>	0.34	0.60
<b>Mn</b>	0.86	0.60~1.10
<b>P</b>	0.004	0.020
<b>S</b>	0.008	0.020
<b>Ni</b>	3.53	3.20~3.90
<b>Mo</b>	0.15	0.30
<b>Cu</b>	0.17	0.35

## Welding parameters (A)

φ mm	Wire	Rod
1.2	50~280	-
1.6	-	60~220
2.0	-	80~240
2.4	-	100~260
3.2	-	150~300

Note: <sup>a</sup> Single values are maximum.

## All-weld mechanical properties

	Typical		Guaranty
<b>0.2%YS (MPa)</b>	510	490	360min.
<b>TS (MPa)</b>	580	570	483min.
<b>EI on 4d (%)</b>	30	31	24min.
<b>IV -101°C (J)</b>	350	345	-105°C: 27min.
<b>PWHT (°Cxh)</b>	AW	620x1	AW & 620±15x1

## TIG welding rod and wire

<b>Features:</b>	▪ Suitable for 550 to 590MPa tensile strength steel
<b>Classification:</b>	AWS A5.28 ER80S-G
<b>Shielding gas:</b>	Ar
<b>Identification color:</b>	1st White
<b>Polarity:</b>	DCEN

## Packaging data

φ mm	Tube		
	kg	Length mm	g/piece
1.6	5	1,000	16
2.0	5	1,000	25
2.4	5	1,000	35
3.2	5	1,000	63
<b>Volume mm</b>	40W, 35H, 1015L		

## Composition (wire mass%)

	Typical	Guaranty <sup>a</sup>
<b>C</b>	0.08	0.10
<b>Si</b>	0.74	0.30~0.85
<b>Mn</b>	1.38	1.15~1.65
<b>P</b>	0.007	0.020
<b>S</b>	0.006	0.020
<b>Ni</b>	0.03	0.60
<b>Mo</b>	0.52	0.25~0.65
<b>Cu</b>	0.16	0.50

Note: <sup>a</sup>Single values are maximum.

## Welding parameters (A)

φ mm	Rod
1.6	60~220
2.0	80~240
2.4	100~260
3.2	150~300

## All-weld mechanical properties

	Typical		Guaranty
	<b>0.2%YS (MPa)</b>	540	530
<b>TS (MPa)</b>	660	640	552min.
<b>El on 4d (%)</b>	28	26	18min.
<b>IV -20°C (J)</b>	180	98	27min.
<b>PWHT (°C×h)</b>	AW	620x1	AW & 620±15x1

## TIG welding rod and wire

<b>Features:</b>	▪ Suitable for 550 to 610MPa tensile strength steel
<b>Classification:</b>	AWS A5.28 ER80S-G
<b>Shielding gas:</b>	Ar
<b>Identification color:</b>	1st Orange
<b>Polarity:</b>	DCEN

## Packaging data

φ mm	Spool		Tube	
	kg	kg	Length mm	g/piece
1.2	10	-	-	-
1.6	-	5	1,000	16
2.0	-	5	1,000	25
2.4	-	5	1,000	35
<b>Volume mm</b>	240W, 110H, 230L		40W, 35H, 1015L	

## Composition (wire mass%)

	Typical	Guaranty <sup>a</sup>
<b>C</b>	0.10	0.12
<b>Si</b>	0.05	0.20
<b>Mn</b>	1.43	1.00~1.60
<b>P</b>	0.004	0.025
<b>S</b>	0.007	0.025
<b>Ni</b>	0.82	0.60~1.00
<b>Mo</b>	0.58	0.30~0.65
<b>Cu</b>	0.15	0.50

Note: <sup>a</sup>Single values are maximum.

## Welding parameters (A)

φ mm	Wire	Rod
1.2	50~280	-
1.6	-	60~220
2.0	-	80~240
2.4	-	100~260

## All-weld mechanical properties

	Typical		Guaranty
	<b>0.2%YS (MPa)</b>	590	590
<b>TS (MPa)</b>	670	660	552min.
<b>El on 4d (%)</b>	28	30	18min.
<b>IV -60°C (J)</b>	270	280	27min.
<b>PWHT (°C×h)</b>	AW	600x1	AW & 600±15x1

## Approvals

<b>ABS</b>	5YQ460SA
<b>LR</b>	5Y46m, H5
<b>DNV</b>	VY46MS

**TIG welding rod and wire**

<b>Features:</b>	▪ Suitable for 780MPa tensile strength steel
<b>Classification:</b>	AWS A5.28 ER110S-G
<b>Shielding gas:</b>	Ar
<b>Identification color:</b>	-
<b>Polarity:</b>	DCEN

**Packaging data**

φ mm	Spool		Tube	
	kg	kg	Length mm	g/piece
1.2	10	5	1,000	9
1.6	-	5	1,000	16
2.0	-	5	1,000	25
2.4	-	5	1,000	35
<b>Volume mm</b>	240W, 110H, 230L		40W, 35H, 1015L	

**Composition (wire mass%)**

	Typical	Guaranty <sup>a</sup>
<b>C</b>	0.07	0.12
<b>Si</b>	0.07	0.20
<b>Mn</b>	1.10	0.90~1.40
<b>P</b>	0.004	0.025
<b>S</b>	0.008	0.025
<b>Ni</b>	2.92	2.60~3.10
<b>Cr</b>	0.36	0.10~0.60
<b>Mo</b>	0.69	0.40~0.90
<b>Cu</b>	0.14	0.50

Note: <sup>a</sup>Single values are maximum.

**Welding parameters (A)**

φ mm	Wire	Rod
1.2	50~280	-
1.6	-	60~220
2.0	-	80~240
2.4	-	100~260

**All-weld mechanical properties**

	Typical	Guaranty
<b>0.2%YS (MPa)</b>	760	665min.
<b>TS (MPa)</b>	880	759min.
<b>El on 4d (%)</b>	23	15min.
<b>IV -60°C (J)</b>	240	27min.

**Approvals**

<b>ABS</b>	5YQ690A H5, 5YQ690SA H5
<b>LR</b>	5Y69m H5, 5Y69M H5 (Auto)
<b>DNV</b>	VY69M, H5
<b>BV</b>	SA5Y69M H5
<b>NK</b>	KSW5Y69G (I) H5
<b>CCS</b>	5Y69SM H5

# FAMILIARC™ MF-38/ TRUSTARC™ US-49A

## Flux and wire combination

- Features:**
- Suitable for multi-layer butt welding
  - Excellent impact value down to -40°C

**Classification:** AWS A5.17 F7A6-EH14, F7P6-EH14

**Type of flux:** Fused

**Redrying of flux:** 150~350°Cx1h

**Polarity:** AC

## Packaging data

Flux	Mesh	Can		
MF-38	12x65	25kg		
	20x200	25kg		
	20xD	25kg		
Volume mm		240W, 350H, 240L		
Wire	φ mm	Coil		
US-49A	2.4	25kg	-	-
	3.2	25kg	-	150kg
	4.0	25kg	75kg	150kg
	4.8	25kg	75kg	-
Volume mm		430W, 90H, 430L	740W, 110H, 740L	840W, 110H, 840L

## Composition (wire mass%)

	Typical	Guaranty <sup>a</sup>
<b>C</b>	0.12	0.10~0.20
<b>Si</b>	0.02	0.10
<b>Mn</b>	1.99	1.70~2.20
<b>P</b>	0.007	0.030
<b>S</b>	0.005	0.030
<b>Mo</b>	0.24	0.15~0.35

Note: <sup>a</sup>Single values are maximum.

## Weld mechanical properties

	Typical		Guaranty
<b>0.2%YS (MPa)</b>	540	490	400min.
<b>TS (MPa)</b>	620	590	483~655
<b>El on 4d (%)</b>	28	30	22min.
<b>IV -51°C (J)</b>	50	60	27min.
<b>PWHT (°C×h)</b>	AW	620x1	AW & 620±15x1

## Composition (weld metal mass%)

	Typical
<b>C</b>	0.09
<b>Si</b>	0.40
<b>Mn</b>	1.63
<b>P</b>	0.019
<b>S</b>	0.013
<b>Mo</b>	0.21



# TRUSTARC™ PF-H55LT/ FAMILIARC™ US-36

## Flux and wire combination

- Features:**
- Suitable for welding of structures for low temperature service
  - Excellent impact value down to -60°C and CTOD down to -50°C

**Classification:** AWS A5.17 F7A8-EH14, F7P8-EH14

**Type of flux:** Bonded

**Redrying of flux:** 200~300°Cx1h

**Polarity:** AC

## Packaging data

Flux	Mesh	Can		
PF-H55LT	10x48	20kg		
Volume mm		240W, 350H, 240L		
Wire	φ mm	Coil		
US-36	3.2	25kg	76kg	-
	4.0	25kg	75kg	150kg
	4.8	25kg	75kg	150kg
Volume mm		430W, 90H, 430L	740W, 110H, 740L	840W, 110H, 840L

## Composition (wire mass%)

	Typical	Guaranty <sup>a</sup>
<b>C</b>	0.12	0.10~0.20
<b>Si</b>	0.03	0.10
<b>Mn</b>	1.95	1.70~2.20
<b>P</b>	0.013	0.030
<b>S</b>	0.008	0.030
<b>Cu</b>	0.12	0.35

Note: <sup>a</sup> Single values are maximum.

## Weld mechanical properties

	Typical		Guaranty
<b>0.2%YS (MPa)</b>	490	460	400min.
<b>TS (MPa)</b>	555	540	483~655
<b>El on 4d (%)</b>	34	34	22min.
<b>IV -62°C (J)</b>	180	160	27min.
<b>PWHT (°Cxh)</b>	AW	620x1	AW & 620±15x1

## Composition (weld metal mass%)

	Typical
<b>C</b>	0.08
<b>Si</b>	0.19
<b>Mn</b>	1.42
<b>P</b>	0.013
<b>S</b>	0.005
<b>Ti</b>	0.02
<b>B</b>	0.004

## Approvals

	Single	Tandem
<b>ABS</b>	3M, 3YM, MG	4YM, MG
<b>LR</b>	5Y40M, H5	-
<b>DNV</b>	V YM, VL2-4, VL4-4	V YM
<b>BV</b>	A4YM, UP	-
<b>NK</b>	KAWL3M	KAWL3M

## Flux and wire combination

- Features:**
- Suitable for welding of structures for low temperature service
  - Excellent impact value down to -60°C and CTOD at temperatures down to -20°C

**Classification:** AWS A5.17 F7A8-EH14, F7P8-EH14

**Type of flux:** Bonded

**Redrying of flux:** 200~300°Cx1h

**Polarity:** DCEP

## Packaging data

Flux	Mesh	Can	
PF-H55AS	10x48	20kg	
Volume mm		240W, 350H, 240L	
Wire	φ mm	Coil	
US-36J	3.2	25kg	76kg
	4.0	25kg	75kg
	4.8	25kg	75kg
Volume mm		430W, 90H, 430L	740W, 110H, 740L

## Composition (wire mass%)

	Typical	Guaranty <sup>a</sup>
<b>C</b>	0.13	0.10~0.20
<b>Si</b>	0.01	0.10
<b>Mn</b>	2.00	1.70~2.20
<b>P</b>	0.007	0.030
<b>S</b>	0.008	0.030
<b>Cu</b>	0.10	0.35

Note: <sup>a</sup>Single values are maximum.

## Weld mechanical properties

	Typical		Guaranty
<b>0.2%YS (MPa)</b>	485	430	400min.
<b>TS (MPa)</b>	555	530	483~655
<b>EI on 4d (%)</b>	33	31	22min.
<b>IV -62°C (J)</b>	170	180	27min.
<b>PWHT (°Cxh)</b>	AW	620x1	AW & 620±15x1

## Composition (weld metal mass%)

	Typical
<b>C</b>	0.07
<b>Si</b>	0.23
<b>Mn</b>	1.42
<b>P</b>	0.009
<b>S</b>	0.004
<b>Ti</b>	0.02
<b>B</b>	0.004

## Approvals

	Single	Tandem
<b>ABS</b>	5Y400 H5	5Y400 H5
<b>LR</b>	5Y40M, H5	5Y40M, H5
<b>DNV</b>	VY40M (H5), VL2-4L, VL4-4L	VY40M (H5), VL2-4L, VL4-4L
<b>BV</b>	A5Y40M, H5	A5Y40M, H5
<b>NK</b>	KAWL3MH5	KAWL3M H10

**Flux and wire combination**

**Features:**

- Suitable for multi-layer butt welding of 3.5% Ni steel
- Excellent impact value down to -100°C after PWHT

**Classification:** AWS A5.23 F7P15-ENi3-Ni3

**Type of flux:** Bonded

**Redrying of flux:** 200~300°Cx1h

**Polarity:** AC

**Packaging data**

Flux	Mesh	Can
PF-H203	10x48	20kg
Volume mm		240W, 350H, 240L
Wire	φ mm	Coil
US-203E	4.0	25kg
Volume mm		430W, 90H, 430L

**Composition (wire mass%)**

	Typical	Guaranty <sup>a</sup>
<b>C</b>	0.06	0.13
<b>Si</b>	0.18	0.05~0.30
<b>Mn</b>	0.98	0.60~1.20
<b>P</b>	0.005	0.020
<b>S</b>	0.002	0.020
<b>Ni</b>	3.48	3.10~3.80
<b>Cr</b>	0.03	0.15
<b>Cu</b>	0.11	0.35

Note: <sup>a</sup>Single values are maximum.

**Weld mechanical properties**

	Typical	Guaranty
<b>0.2%YS (MPa)</b>	440	400min.
<b>TS (MPa)</b>	530	483~655
<b>EI on 4d (%)</b>	34	22min.
<b>IV -101°C (J)</b>	130	27min.
<b>PWHT (°C×h)</b>	610x1	620±15x1

**Composition (weld metal mass%)**

	Typical	Guaranty <sup>a</sup>
<b>C</b>	0.04	0.12
<b>Si</b>	0.21	0.80
<b>Mn</b>	0.73	1.60
<b>P</b>	0.008	0.030
<b>S</b>	0.004	0.025
<b>Ni</b>	3.35	2.80~3.80
<b>Cr</b>	0.02	0.15
<b>Cu</b>	0.10	0.35

Note: <sup>a</sup>Single values are maximum.

# FAMILIARC™ MF-38/ TRUSTARC™ US-A4

## Flux and wire combination

- Features:**
- Suitable for butt and fillet welding
  - Applicable for 0.5%Mo steel

**Classification:** AWS A5.23 F8A4-EA4-A4, F8P6-EA4-A4

**Type of flux:** Fused

**Redrying of flux:** 150~350°Cx1h

**Polarity:** AC

## Packaging data

Flux	Mesh	Can	Wire	φ mm	Coil
MF-38	12x65	25kg	US-A4	3.2	25kg
	20x200	25kg		4.0	25kg
	20xD	25kg		4.8	25kg
Volume mm		240W, 350H, 240L	Volume mm		430W, 90H, 430L

## Composition (wire mass%)

	Typical	Guaranty <sup>a</sup>
<b>C</b>	0.09	0.07~0.12
<b>Si</b>	0.04	0.05
<b>Mn</b>	1.59	1.25~1.70
<b>P</b>	0.01	0.025
<b>S</b>	0.014	0.025
<b>Ni</b>	0.02	0.25
<b>Cr</b>	0.04	0.15
<b>Mo</b>	0.52	0.45~0.60
<b>Cu</b>	0.10	0.35

Note: <sup>a</sup> Single values are maximum.

## Composition (weld metal mass%)

	Typical	Guaranty <sup>a</sup>
<b>C</b>	0.10	0.15
<b>Si</b>	0.39	0.80
<b>Mn</b>	1.35	1.60
<b>P</b>	0.013	0.030
<b>S</b>	0.013	0.030
<b>Mo</b>	0.52	0.40~0.65
<b>Cu</b>	0.11	0.35

Note: <sup>a</sup> Single values are maximum.

## Weld mechanical properties

	Typical		Guaranty	
<b>0.2%YS (MPa)</b>	520	510	469min.	
<b>TS (MPa)</b>	640	600	552~689	
<b>EI on 4d (%)</b>	28	29	20min.	
<b>IV (J)</b>	-40°C: 37	-51°C: 40	-40°C: 27min.	-51°C: 27min.
<b>PWHT (°Cxh)</b>	AW		AW	620±15x1

# FAMILIARC™ MF-38 / TRUSTARC™ US-40

## Flux and wire combination

- Features:**
- Suitable for butt and fillet welding
  - Applicable for 0.5%Mo steel

**Classification:** AWS A5.23 F9A6-EA3-A3, F8P6-EA3-A3

**Type of flux:** Fused

**Redrying of flux:** 150~350°Cx1h

**Polarity:** AC

## Packaging data

Flux	Mesh	Can	Wire	φ mm	Coil	
MF-38	12x65	25kg	US-40	2.4	25kg	-
	20x200	25kg		3.2	25kg	-
	20xD	25kg		4.0	25kg	75kg
	-	-		4.8	25kg	75kg
<b>Volume mm</b>		240W, 350H, 240L	<b>Volume mm</b>		430W, 90H, 430L	740W, 110H, 740L

## Composition (wire mass%)

	Typical	Guaranty <sup>a</sup>
<b>C</b>	0.13	0.10~0.17
<b>Si</b>	0.02	0.05
<b>Mn</b>	1.80	1.70~2.10
<b>P</b>	0.009	0.025
<b>S</b>	0.014	0.025
<b>Ni</b>	0.02	0.25
<b>Cr</b>	0.06	0.15
<b>Mo</b>	0.52	0.45~0.65
<b>Cu</b>	0.11	0.35

Note: <sup>a</sup> Single values are maximum.

## Weld mechanical properties

	Typical		Guaranty	
<b>0.2%YS (MPa)</b>	580	560	538min.	469min.
<b>TS (MPa)</b>	670	630	621~758	552~689
<b>El on 4d (%)</b>	28	29	17min.	20min.
<b>IV -51°C (J)</b>	51	58	27min.	27min.
<b>PWHT (°Cxh)</b>	AW	620x1	AW	620±15x1

## Composition (weld metal mass%)

	Typical	Guaranty <sup>a</sup>
<b>C</b>	0.08	0.15
<b>Si</b>	0.34	0.80
<b>Mn</b>	1.58	2.10
<b>P</b>	0.017	0.030
<b>S</b>	0.009	0.030
<b>Mo</b>	0.45	0.40~0.65
<b>Cu</b>	0.12	0.35

Note: <sup>a</sup> Single values are maximum.

## Approvals

NK	KAW3Y50M H10
----	--------------

Note: Single electrode

# FAMILIARC™ MF-38/ TRUSTARC™ US-49

## Flux and wire combination

- Features:**
- Suitable for butt and fillet welding
  - Applicable for 0.5%Mo steel

**Classification:** AWS A5.23 F8A4-EG-A4, F8P6-EG-A4

**Type of flux:** Fused

**Redrying of flux:** 150~350°Cx1h

**Polarity:** AC

## Packaging data & Type of flux

Flux	Mesh	Can			
MF-38	12x65	25kg			
	20x200	25kg			
	20xD	25kg			
Volume mm		240W, 350H, 240L			
Wire	φ mm	Spool		Coil	
US-49	1.6	-	20kg	-	-
	2.4	10kg	-	25kg	-
	3.2	-	-	25kg	76kg
	4.0	-	-	25kg	75kg
	4.8	-	-	25kg	75kg
	6.4	-	-	25kg	-
Volume mm		240W, 110H, 240L	300W, 110H, 300L	430W, 90H, 430L	740W, 110H, 740L

## Composition (wire mass%)

	Typical	Guaranty <sup>a</sup>
<b>C</b>	0.10	0.07~0.12
<b>Si</b>	0.03	0.05
<b>Mn</b>	1.58	1.25~1.80
<b>P</b>	0.009	0.025
<b>S</b>	0.011	0.025
<b>Ni</b>	0.02	0.25
<b>Cr</b>	0.05	0.15
<b>Mo</b>	0.52	0.45~0.60
<b>Cu</b>	0.12	0.35

Note: <sup>a</sup>Single values are maximum.

## Composition (weld metal mass%)

	Typical	Guaranty <sup>a</sup>
<b>C</b>	0.10	0.15
<b>Si</b>	0.37	0.80
<b>Mn</b>	1.35	1.60
<b>P</b>	0.014	0.030
<b>S</b>	0.014	0.030
<b>Mo</b>	0.53	0.40~0.65
<b>Cu</b>	0.09	0.35

Note: <sup>a</sup>Single values are maximum.

## Weld mechanical properties

	Typical		Guaranty	
	<b>0.2%YS (MPa)</b>	520	510	470min.
<b>TS (MPa)</b>	640	600	550~690	
<b>EI on 4d (%)</b>	28	29	20min.	
<b>IV (J)</b>	-40°C: 37	-51°C: 40	-40°C: 27min.	-51°C: 27min.
<b>PWHT (°Cxh)</b>	AW	600x3	AW	620±15x1

## Approvals

<b>ABS</b>	3YM
<b>LR</b>	3YM
<b>DNV</b>	IIIYM
<b>BV</b>	A3YM
<b>NK</b>	KAW3Y46M H10
<b>CCS</b>	3YM

**Flux and wire combination**

- Features:**
- Suitable for welding of structures for low temperature service
  - Excellent impact value down to -60°C and CTOD at temperatures down to -20°C

**Classification:** AWS A5.23 F9A10-EG-Ni2, F9P8-EG-Ni2

**Type of flux:** Bonded

**Redrying of flux:** 200~300°Cx1h

**Polarity:** AC

**Packaging data**

Flux	Mesh	Can	
PF-H55S	10x48	20kg	
Volume mm		240W, 350H, 240L	
Wire	φ mm	Coil	
US-2N	3.2	25kg	-
	4.0	25kg	75kg
	4.8	25kg	-
Volume mm		430W, 90H, 430L	740W, 110H, 740L

**Composition (wire mass%)**

	Typical	Guaranty <sup>a</sup>
<b>C</b>	0.12	0.15
<b>Si</b>	0.01	0.10
<b>Mn</b>	1.70	1.50~1.90
<b>P</b>	0.007	0.015
<b>S</b>	0.004	0.015
<b>Ni</b>	2.60	2.40~2.80
<b>Mo</b>	0.25	0.20~0.30
<b>Cu</b>	0.10	0.35

Note: <sup>a</sup>Single values are maximum.

**Weld mechanical properties**

	Typical		Guaranty
<b>0.2%YS (MPa)</b>	610	590	538min.
<b>TS (MPa)</b>	675	645	621~758
<b>El on 4d (%)</b>	30	30	17min.
<b>IV -62°C (J)</b>	140	120	27min.
<b>PWHT (°Cxh)</b>	AW	620x2	AW & 620±15x2

**Composition (weld metal mass%)**

	Typical
<b>C</b>	0.06
<b>Si</b>	0.22
<b>Mn</b>	1.22
<b>P</b>	0.006
<b>S</b>	0.004
<b>Ni</b>	2.39
<b>Mo</b>	0.21
<b>Cu</b>	0.11

**Approvals**

<b>LR</b>	5Y50M H5
<b>NK</b>	KAW5Y50M H5

Note: Single electrode

## Flux and wire combination

- Features:**
- Suitable for welding of structures for low temperature service
  - Excellent impact value down to -60°C and CTOD at temperature to -20°C

**Classification:** AWS A5.23 F9A8-EG-Ni2, F9P8-EG-Ni2

**Type of flux:** Bonded

**Redrying of flux:** 200~300°Cx1h

**Polarity:** DCEP

## Packaging data

Flux	Mesh	Can	
PF-H62AS	10x48	20kg	
Volume mm		240W, 350H, 240L	
Wire	φ mm	Coil	
US-2N	3.2	25kg	-
	4.0	25kg	75kg
	4.8	25kg	-
Volume mm		430W, 90H, 430L	740W, 110H, 740L

## Composition (wire mass%)

	Typical	Guaranty <sup>a</sup>
<b>C</b>	0.12	0.15
<b>Si</b>	0.01	0.10
<b>Mn</b>	1.70	1.50~1.90
<b>P</b>	0.007	0.015
<b>S</b>	0.004	0.015
<b>Ni</b>	2.60	2.40~2.80
<b>Mo</b>	0.25	0.20~0.30
<b>Cu</b>	0.10	0.35

Note: <sup>a</sup>Single values are maximum.

## Weld mechanical properties

	Typical		Guaranty
<b>0.2%YS (MPa)</b>	568	550	538min.
<b>TS (MPa)</b>	648	635	621~758
<b>EI on 4d (%)</b>	29	30	17min.
<b>IV -62°C (J)</b>	120	110	27min.
<b>PWHT (°C×h)</b>	AW	620x2	AW & 620±15x2

## Composition (weld metal mass%)

	Typical
<b>C</b>	0.05
<b>Si</b>	0.25
<b>Mn</b>	1.30
<b>P</b>	0.011
<b>S</b>	0.005
<b>Ni</b>	2.46
<b>Mo</b>	0.24
<b>Cu</b>	0.10

## Approvals

	Single	Tandem
<b>ABS</b>	5YQ500 H5	5YQ500 H5
<b>LR</b>	5Y50M H5	5Y50M H5
<b>DNV</b>	VY50M H5	VY50 H5
<b>BV</b>	A5Y50M H5	A5Y50M H5
<b>NK</b>	KAW5Y50M H5	KAW5Y50M H5
<b>CCS</b>	5Y50M H5	5Y50M H5



**Flux and wire combination**

- Features:**
- Suitable for welding of structures for low temperature service
  - Excellent impact value down to -60°C in the as-welded and PWHT conditions

**Classification:** AWS A5.23 F9A8-EG-Ni2, F9P8-EG-Ni2

**Type of flux:** Bonded

**Redrying of flux:** 200~300°Cx1h

**Polarity:** AC

**Packaging data**

Flux	Mesh	Can	
PF-H62AK	10x48	20kg	
Volume mm		240W, 350H, 240L	
Wire	φ mm	Coil	
US-2N	3.2	25kg	-
	4.0	25kg	75kg
	4.8	25kg	-
Volume mm		430W, 90H, 430L	740W, 110H, 740L

**Composition (wire mass%)**

	Typical	Guaranty <sup>a</sup>
<b>C</b>	0.12	0.15
<b>Si</b>	0.01	0.10
<b>Mn</b>	1.70	1.50~1.90
<b>P</b>	0.007	0.015
<b>S</b>	0.004	0.015
<b>Ni</b>	2.60	2.40~2.80
<b>Mo</b>	0.25	0.20~0.30
<b>Cu</b>	0.10	0.35

Note: <sup>a</sup> Single values are maximum.

**Weld mechanical properties**

	Typical		Guaranty
<b>0.2%YS (MPa)</b>	615	575	538min.
<b>TS (MPa)</b>	690	650	621~758
<b>El on 4d (%)</b>	26	30	17min.
<b>IV -62°C (J)</b>	170	160	27min.
<b>PWHT (°C×h)</b>	AW	620x2	AW & 620±15x2

**Composition (weld metal mass%)**

	Typical
<b>C</b>	0.08
<b>Si</b>	0.17
<b>Mn</b>	1.31
<b>P</b>	0.005
<b>S</b>	0.003
<b>Ni</b>	2.33
<b>Mo</b>	0.22
<b>Cu</b>	0.11

## Flux and wire combination

- Features:**
- Suitable for welding of heavy duty structures
  - Excellent impact value down to -80°C

**Classification:** AWS A5.23 F11A10-EG-G

**Type of flux:** Bonded

**Redrying of flux:** 250~350°Cx1h

**Polarity:** DCEP

## Packaging data

Flux	Mesh	Can	Wire	φ mm	Coil
PF-H80AS	10x48	20kg	US-80LT	3.2	25kg
				4.0	25kg
				4.8	25kg
Volume mm		240W, 350H, 240L	Volume mm		430W, 90H, 430L

## Composition (wire mass%)

	Typical	Guaranty <sup>a</sup>
<b>C</b>	0.10	0.15
<b>Si</b>	0.11	0.25
<b>Mn</b>	2.03	1.75~2.25
<b>P</b>	0.007	0.015
<b>S</b>	0.004	0.015
<b>Ni</b>	2.59	2.40~2.90
<b>Mo</b>	0.74	0.60~0.90
<b>Cu</b>	0.12	0.40

Note: <sup>a</sup>Single values are maximum.

## Weld mechanical properties

	Typical	Guaranty
<b>0.2%YS (MPa)</b>	740	676min.
<b>TS (MPa)</b>	860	759~896
<b>EI on 4d (%)</b>	23	15min.
<b>IV -73°C (J)</b>	83	27min.

## Composition (weld metal mass%)

	Typical	Guaranty <sup>a</sup>
<b>C</b>	0.06	0.12
<b>Si</b>	0.51	0.80
<b>Mn</b>	1.64	1.20~2.20
<b>P</b>	0.011	0.030
<b>S</b>	0.002	0.030
<b>Ni</b>	2.42	2.10~2.90
<b>Mo</b>	0.73	0.50~1.00
<b>Cu</b>	0.11	0.35

Note: <sup>a</sup>Single values are maximum.

## Approvals

<b>ABS</b>	4YQ690, MG
<b>LR</b>	4Y69M (H5)
<b>DNV</b>	IVY69M (H5), MG
<b>BV</b>	4Y69M H5, MG
<b>CCS</b>	4Y69M H5, MG
<b>NK</b>	KAW4Y69M, H5

Note: Single electrode

**Flux and wire combination**

**Features:**

- Suitable for welding of heavy duty structures
- Excellent impact value down to -80°C

**Classification:** AWS A5.23 F12A10-EG-G

**Type of flux:** Bonded

**Redrying of flux:** 250~350°Cx1h

**Polarity:** AC

**Packaging data**

Flux	Mesh	Can	Wire	φ mm	Coil
PF-H80AK	10x48	20kg	US-80LT	3.2	25kg
				4.0	25kg
				4.8	25kg
Volume mm		240W, 350H, 240L	Volume mm		430W, 90H, 430L

**Composition (wire mass%)**

	Typical	Guaranty <sup>a</sup>
<b>C</b>	0.10	0.15
<b>Si</b>	0.11	0.25
<b>Mn</b>	2.03	1.75~2.25
<b>P</b>	0.007	0.015
<b>S</b>	0.004	0.015
<b>Ni</b>	2.59	2.40~2.90
<b>Mo</b>	0.74	0.60~0.90
<b>Cu</b>	0.12	0.40

Note: <sup>a</sup>Single values are maximum.

**Weld mechanical properties**

	Typical	Guaranty
<b>0.2%YS (MPa)</b>	760	745min.
<b>TS (MPa)</b>	840	828~965
<b>EI on 4d (%)</b>	22	14min.
<b>IV -73°C (J)</b>	90	27min.

**Composition (weld metal mass%)**

	Typical	Guaranty <sup>a</sup>
<b>C</b>	0.08	0.12
<b>Si</b>	0.28	0.80
<b>Mn</b>	1.65	1.20~2.20
<b>P</b>	0.009	0.030
<b>S</b>	0.004	0.030
<b>Ni</b>	2.45	2.10~2.90
<b>Mo</b>	0.74	0.50~1.00
<b>Cu</b>	0.12	0.35

Note: <sup>a</sup>Single values are maximum.

**Approvals**

	Single	Tandem
<b>ABS</b>	5YQ690, H5	5YQ690 H5
<b>LR</b>	5Y69M, H5	-
<b>DNV</b>	VY69M	VY69M H5
<b>BV</b>	A5Y69M H5	A5Y69M H5
<b>NK</b>	KAW5Y69M, H5	KAW5Y69M H5



# **For Heat-Resistant Steel**

## **Welding Consumables for**

**SMAW**

**GMAW**

**GTAW**

**SAW**

# SMAW, GMAW, GTAW, SAW

## A guide for selecting welding consumables

Type of steel	ASTM steel grade		SMAW
	Plate	Pipe / Tube	
Mn-Mo Mn-Mo-Ni	A302Gr.B, C, D A533Type A, B, C, D	-	<b>BL-96</b> <b>BL-106</b>
0.5Mo	A204Gr.A, B, C	A209Gr.T1 A335Gr.P1	<b>CM-A76</b>
1Cr-0.5Mo 1.25Cr-0.5Mo	A387Gr.12 Cl.1, Cl.2 A387Gr.11 Cl.1, Cl.2	A213Gr.T11,T12 A335Gr.P11,P12	<b>CM-A96</b> <b>CM-A96MB</b> <b>CM-A96MBD</b> <b>CM-B95</b> <b>CM-B98</b>
2.25Cr-1Mo	A387Gr.22 Cl.1, Cl.2	A213Gr.T22 A335Gr.P22	<b>CM-A106</b> <b>CM-A106N</b> <b>CM-A106ND</b> <b>CM-B105</b> <b>CM-B108</b>
2.25Cr-1Mo-V	A542Type D Cl.4a A832Gr.22V	-	<b>CM-A106H</b> <b>CM-A106HD</b>
Low C 2.25Cr-W-V-Nb	-	SA213Gr.T23 SA335Gr.P23	<b>CM-2CW</b>
9Cr-1Mo-V-Nb	A387Gr.91 Cl.2	A213Gr.T91 A335Gr.P91	<b>CM-95B91</b> <b>CM-96B91</b> <b>CM-9Cb</b>
9Cr-W-V-Nb 12Cr-W-V-Nb	-	A213Gr.T92 A335Gr.P92 A213Gr.T122 A335Gr.P122	<b>CR-12S</b>

	<b>GMAW</b>	<b>GTAW</b>	<b>SAW</b>
	<b>MG-S56 MG-S63S</b>	<b>TG-S56 TG-S63S</b>	<b>PF-200/US-56B PF-200/US-63S</b>
	<b>MG-SM MG-S70SA1</b>	<b>TG-SM TG-S70SA1</b>	<b>MF-38/US-40 MF-38/US-49 MF-38/US-A4</b>
	<b>MG-S1CM MG-S80B2F</b>	<b>TG-S80B2 TG-S1CM TG-S1CML</b>	<b>G-80/US-B2 PF-200/US-511N PF-200D/US-511ND PF-200D/US-B2R</b>
	<b>MG-S2CM</b>	<b>TG-S90B3 TG-S2CM TG-S2CML</b>	<b>PF-200/US-521S PF-200D/US-521S</b>
	<b>-</b>	<b>TG-S2CMH</b>	<b>PF-500/US-521H</b>
	<b>MG-S2CW</b>	<b>TG-S2CW</b>	<b>MF-29A/US-2CW</b>
	<b>MG-S90B91 MG-S9Cb</b>	<b>TG-S90B91 TG-S9Cb</b>	<b>PF-200S/US-90B91 PF-90B91/US-90B91 PF-200S/US-9Cb</b>
	<b>MG-S12CRS</b>	<b>TG-S12CRS</b>	<b>PF-200S/US-12CRSD</b>

# SMAW, GMAW, GTAW, SAW

## Tips for better welding results

### SMAW

- (1) Remove scale, rust, oil, grease, water, and other dirt from welding grooves beforehand to prevent defects such as porosity and cracking in the weld metal.
- (2) Use welding currents in the recommended range because the use of excessively high currents can cause imperfections such as poor X-ray soundness, much undercuts, much spatter, and hot cracking.
- (3) Keep the arc length as short as possible to prevent porosity caused by nitrogen in the atmosphere. Limit the weaving width within two and a half times the diameter of the electrode. When striking an arc in the welding groove directly, use the backstep technique or strike an arc on a scrap plate before welding the groove to prevent blowholes in the arc starting bead.
- (4) Use preheating and interpass temperatures in the recommended range as shown in Table 1 in order to prevent the occurrence of cold cracks.
- (5) Use proper postweld heat treatment (PWHT) temperatures to ensure good mechanical properties of the weld. The use of an excessively high temperature can damage the weld causing inadequate tensile strength and impact value of the weld. In contrast, the use of an excessively low temperature can cause poor ductility and impact toughness of the weld in addition to inadequate stress relieving. The recommended ranges of PWHT temperatures are shown in Table 1. Hold weldments at PWHT temperatures for appropriate time according to the thickness of the base metal to ensure the quality of the weld.
- (6) Control heat input in predetermined ranges because heat input can remarkably affect the crack resistibility and mechanical properties of the weld.

Table 1 Recommended temperatures

Type of steel	Preheating and interpass temperature (°C)	PWHT temperature (°C)
Mn-Mo-Ni	150-250	590-650
0.5Mo and 0.5Cr-0.5Mo	100-250	620-680
1Cr-0.5Mo and 1.25Cr-0.5Mo	150-300	650-700
2.25Cr-1Mo	200-350	680-730
5Cr-0.5Mo and 9Cr-1Mo	250-350	710-780
9Cr-1Mo-V-Nb	250-350	710-760*1 750-800*2
9~12Cr-W-V-Nb	250-350	720-760

\*1: For CM-9Cb, MG-S9Cb, TG-S9Cb, and PF-200S/US-9Cb

\*2: For CM-95B91, CM-96B91, TG-S90B91, and PF-90B91/US-90B91



## GMAW

- (1) Use DCEP polarity.
- (2) Use an appropriate shielded gas flow rate as shown in Table 2 for recommendation.
- (3) In spray arc welding with a shielding gas of Ar/O<sub>2</sub> or Ar/5-20%CO<sub>2</sub> admixture, short circuiting noise may occur when the arc voltage is excessively low. In such a case, keep the arc length about 4-5 mm in order to prevent blowholes in the weld metal.
- (4) Refer to (1), (4), (5), (6) of the tips for SMAW.

Table 2 Recommended shielding gas flow rate

Flow rate (liter/min)	Nozzle standoff (mm)	Max wind velocity (m/sec)
20-25	20	2

## GTAW

- (1) Use DCEN polarity.
- (2) Use an appropriate shield gas flow rates as shown in Table 3.
- (3) Use back-shielding to ensure good reverse bead appearance and prevent the occurrence of porosity in the weld metal for low-alloy steels containing Cr over 1.25%.
- (4) Refer to (1), (4), (5), (6) of the tips for SMAW.

Table 3 Recommended shielding gas flow rate

Flow rate (liter/min)	Max. wind velocity (m/sec)
10-15	1

## SAW

- (1) Control flux supply at an appropriate flux-burden height. The flux-burden height can affect the appearance of beads and X-ray soundness. The most appropriate height varies depending on flux mesh size, shape of welding groove and other welding conditions; however, single electrode welding commonly use 25-35 mm while tandem welding generally use 30-45 mm.
- (2) Use lower currents and slower speeds for root pass welding of thick plates to prevent cracking.
- (3) Refer to (1), (4), (5), (6) of the tips for SMAW.

# SMAW, GMAW, GTAW, SAW

## How to select the proper welding consumable for dissimilar metal joints

The structural components of high temperature service equipment such as power generation boiler use several types of steels; therefore, joining dissimilar steels is unavoidable at the interface of different service condition areas. When joining carbon steels and Cr-Mo steels, or when joining dissimilar Cr-Mo steels, a filler metal with a composition similar to the lower-alloy steel or with an intermediate composition is commonly used for butt joints.

For instance, carbon steel can readily be joined to 2.25Cr-1Mo steel by using either a carbon steel or a 1.25Cr-0.5Mo steel filler metal; however, carbon steel filler metals are usually selected except where carbon migration (the diffusion of carbon from lower-Cr metal to higher-Cr metal during PWHT and high temperature service) must be decreased. Likewise, 2.25Cr-1Mo steel can be joined to 9Cr-1Mo-V-Nb steel by using a 2.25Cr-1Mo filler metal.

In contrast, Cr-Mo steel and austenitic stainless steel are joined with a high Cr-Ni stainless (e.g. E309) or, where carbon migration and thermal stress are important factors, nickel alloy (e.g. ENiCrFe-1) filler metal. For a quick guide to recommended welding consumables for joining dissimilar metals, refer to Table 1.

Table 1 A quick guide for joining dissimilar metals <sup>(1) (2)</sup>

Base metal	Mild steel	0.5Mo	1.25Cr-0.5Mo	2.25Cr-1Mo	9Cr-1Mo-V-Nb
<b>Type 304 stainless steel</b>	<ul style="list-style-type: none"> <li>NC-39 (E309), NC-39L (E309L), TG-S309 (ER309), TG-S309L (ER309L)</li> <li>NI-C703D (ENiCrFe-3), NI-C70A (ENiCrFe-1), TG-S70NCb (ERNiCr-3)</li> </ul>				
<b>9Cr-1Mo-V-Nb</b>	LB-52 (E7016) TG-S50 (ER70S-G)	CM-A76 (E7016-A1) TG-SM (ER80S-G)	CM-A96 (E8016-B2) TG-S1CM (ER80S-B2Mn)	CM-A106 (E9016-B3) TG-S2CM (ER90S-B3Mn)	
<b>2.25Cr-1Mo</b>	LB-52 (E7016) TG-S50 (ER70S-G)	CM-A76 (E7016-A1) TG-SM (ER80S-G)	CM-A96 (E8016-B2) TG-S1CM (ER80S-B2Mn)		
<b>1.25Cr-0.5Mo</b>	LB-52 (E7016) TG-S50 (ER70S-G)	CM-A76 (E7016-A1) TG-SM (ER80S-G)			
<b>0.5Mo</b>	LB-52 (E7016) TG-S50 (ER70S-G)				

Note: (1) This table guides to recommended filler metals matching the lower-alloy steels in various dissimilar metal joints, excepting for Type 304 steel. Other types of filler metals may be needed where a specific requirement is imposed.

Note: (2) Preheating and postweld heat treatment for dissimilar Cr-Mo steels should be sufficient to the higher-alloy steel; however, the PWHT temperature should be lower to avoid damage to the lower-alloy steel and minimize the carbon migration. Type 304 stainless steel should not be preheated or postweld heat-treated to avoid sensitization.

**Stick electrode for Mn-Mo and Mn-Mo-Ni steel**

**Features:** Applied for ASTM A533 Type A, B, C, D and equivalents

**Classification:** AWS A5.5 E9016-G

**Redrying Conditions:** 325~375°Cx1h

**Identification color:** 1st Red, 2nd Green

**Polarity:** AC, DCEP

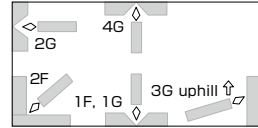
**Welding Positions:****Packaging data**

φ mm	Length mm	kg/pack	kg/carton	g/piece	carton mm
2.6	300	2	20	17	270W, 85H, 330L
3.2	350	5	20	31	170W, 120H, 380L
4.0	400	5	20	55	170W, 120H, 430L
5.0	400	5	20	86	170W, 120H, 430L
6.0	450	5	20	137	170W, 120H, 480L

**Composition (all-weld metal mass%)**

	Typical (AC)	Guaranty <sup>a</sup>
<b>C</b>	0.06	0.12
<b>Si</b>	0.50	0.60
<b>Mn</b>	1.23	0.90~1.70
<b>P</b>	0.01	0.03
<b>S</b>	<0.01	0.03
<b>Ni</b>	0.40	0.20~1.00
<b>Mo</b>	0.58	0.35~0.65

Note: <sup>a</sup> Single values are maximum.

**Welding parameters (A)**

φ mm	1F, 1G, 2F, 2G	3G uphill, 4G
2.6	55~85	50~80
3.2	90~130	80~120
4.0	130~180	110~170
5.0	180~240	-
6.0	240~300	-

**All-weld mechanical properties**

	Typical (AC)	Guaranty
<b>0.2%YS (MPa)</b>	590	531min.
<b>TS (MPa)</b>	670	621min.
<b>EI on 4d (%)</b>	29	17min.
<b>IV -20°C (J)</b>	80	-
<b>PWHT (°Cxh)</b>	630x1	620±15x1

**Stick electrode for Mn-Mo and Mn-Mo-Ni steel**

**Features:** Applied for ASTM A533 Type A, B, C, D class 2 and equivalents

**Classification:** AWS A5.5 E10016-G

**Redrying Conditions:** 325~375°Cx1h

**Identification color:** 1st White, 2nd Red

**Polarity:** AC, DCEP

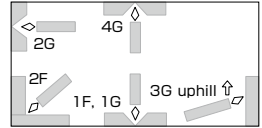
**Welding Positions:****Packaging data**

$\phi$ mm	Length mm	kg/pack	kg/carton	g/piece	carton mm
2.6	300	2	20	17	270W, 85H, 330L
3.2	350	5	20	30	170W, 120H, 380L
4.0	400	5	20	54	170W, 120H, 430L
5.0	400	5	20	84	170W, 120H, 430L

**Composition (all-weld metal mass%)**

	Typical (AC)	Guaranty <sup>a</sup>
<b>C</b>	0.10	0.12
<b>Si</b>	0.53	0.60
<b>Mn</b>	1.41	1.00~1.60
<b>P</b>	0.009	0.020
<b>S</b>	0.005	0.020
<b>Ni</b>	0.76	0.60~1.00
<b>Mo</b>	0.50	0.40~0.65

Note: <sup>a</sup> Single values are maximum.

**Welding parameters (A)**

$\phi$ mm	1F, 1G, 2F, 2G	3G uphill, 4G
2.6	55~85	50~80
3.2	90~130	80~120
4.0	130~180	110~170
5.0	180~240	-

**All-weld mechanical properties**

	Typical (AC)	Guaranty
<b>0.2%YS (MPa)</b>	650	600min.
<b>TS (MPa)</b>	730	689min.
<b>EI on 4d (%)</b>	24	16min.
<b>IV -20°C (J)</b>	80	-
<b>PWHT (°Cxh)</b>	620x2	620±15x1

## Stick electrode for 0.5%Mo steel

**Features:** ▪ Applied for ASTM A204 Gr. A, B, C and equivalents

**Classification:** AWS A5.5 E7016-A1

**Redrying Conditions:** 325~375°Cx1h

**Identification color:** 1st Brown

**Polarity:** AC, DCEP

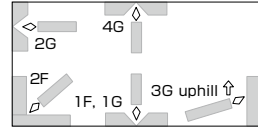
**Welding Positions:****Packaging data**

φ mm	Length mm	kg/pack	kg/carton	g/piece	carton mm
2.6	300	2	20	17	170W, 120H, 330L
3.2	350	5	20	30	170W, 120H, 380L
4.0	400	5	20	55	170W, 120H, 430L
5.0	400	5	20	86	170W, 120H, 430L

**Composition (all-weld metal mass%)**

	Typical (AC)	Guaranty <sup>a</sup>
<b>C</b>	0.08	0.12
<b>Si</b>	0.53	0.60
<b>Mn</b>	0.79	0.90
<b>P</b>	0.01	0.03
<b>S</b>	<0.01	0.03
<b>Mo</b>	0.49	0.40~0.65

Note: <sup>a</sup>Single values are maximum.

**Welding parameters (A)**

φ mm	1F, 1G, 2F, 2G	3G uphill, 4G
2.6	55~85	50~80
3.2	90~130	80~120
4.0	140~190	110~170
5.0	190~240	-

**All-weld mechanical properties**

	Typical (AC)	Guaranty
<b>0.2%YS (MPa)</b>	550	393min.
<b>TS (MPa)</b>	630	483min.
<b>El on 4d (%)</b>	29	22min.
<b>IV 0°C (J)</b>	210	-
<b>PWHT (°C/h)</b>	620x1	620±15x1

## Stick electrode for 1-1.25%Cr-0.5%Mo steel

**Features:** Applied for ASTM A387 Gr.11, Gr.12 and equivalents

**Welding Positions:**

**Classification:** AWS A5.5 E8016-B2

**Redrying Conditions:** 325~375°Cx1h

**Identification color:** 1st Silver, 2nd Black

**Polarity:** AC, DCEP

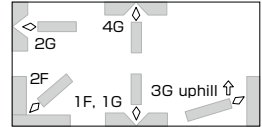
**Packaging data**

φ mm	Length mm	kg/pack	kg/carton	g/piece	carton mm
2.6	300	2	20	17	270W, 85H, 330L
3.2	350	5	20	29	170W, 110H, 380L
4.0	400	5	20	53	170W, 115H, 430L
5.0	400	5	20	82	170W, 120H, 430L
6.0	400	5	20	122	170W, 120H, 430L

**Composition (all-weld metal mass%)**

	Typical (AC)	Guaranty <sup>a</sup>
<b>C</b>	0.06	0.05~0.12
<b>Si</b>	0.48	0.60
<b>Mn</b>	0.81	0.90
<b>P</b>	0.01	0.03
<b>S</b>	<0.01	0.03
<b>Cr</b>	1.31	1.00~1.50
<b>Mo</b>	0.55	0.40~0.65

Note: <sup>a</sup> Single values are maximum.

**Welding parameters (A)**

φ mm	1F, 1G, 2F, 2G	3G uphill, 4G
2.6	55~85	50~80
3.2	80~120	75~110
4.0	125~175	100~160
5.0	185~235	-
6.0	240~300	-

**All-weld mechanical properties**

	Typical (AC)		Guaranty
<b>Temp. (°C)</b>	RT	450	RT
<b>0.2%YS (MPa)</b>	570	460	462min.
<b>TS (MPa)</b>	650	520	552min.
<b>El on 4d (%)</b>	26	21	19min.
<b>IV 0°C (J)</b>	210	-	-
<b>PWHT (°Cxh)</b>	690x1	690x1	690±15x1

**Approvals**

<b>ABS</b>	MG (AWS A5.5 E8016-B2)
<b>LR</b>	MG
<b>DNV</b>	MG (VL1Cr0.5Mo), H10
<b>BV</b>	UP (E8016-B2)
<b>NK</b>	MG (AWS A5.5 E8016-B2)

## Stick electrode for 1-1.25%Cr-0.5%Mo steel

- Features:**
- Applied for ASTM A387 Gr.11, Gr.12 and equivalents
  - Lower TS, higher IV and less sensitive to temper embrittlement

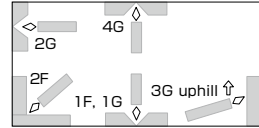
**Welding Positions:**

**Classification:** AWS A5.5 E8016-B2

**Redrying Conditions:** 325~375°Cx1h

**Identification color:** 1st Silver, 2nd Silver grey

**Polarity:** AC

**Packaging data**

φ mm	Length mm	kg/pack	kg/carton	g/piece	carton mm
2.6	300	2	20	17	270W, 85H, 330L
3.2	350	5	20	30	170W, 110H, 380L
4.0	400	5	20	54	170W, 115H, 430L
5.0	400	5	20	84	170W, 110H, 430L
6.0	400	5	20	120	170W, 120H, 430L

**Composition (all-weld metal mass%)**

	Typical	Guaranty <sup>a</sup>
<b>C</b>	0.06	0.05~0.12
<b>Si</b>	0.48	0.60
<b>Mn</b>	0.78	0.90
<b>P</b>	0.01	0.03
<b>S</b>	<0.01	0.03
<b>Cr</b>	1.35	1.00~1.50
<b>Mo</b>	0.57	0.40~0.65

Note: <sup>a</sup> Single values are maximum.

**Welding parameters (A)**

φ mm	1F, 1G, 2F, 2G	3G uphill, 4G
2.6	55~85	50~80
3.2	80~120	75~110
4.0	125~175	100~160
5.0	185~235	-
6.0	240~300	-

**All-weld mechanical properties**

	Typical		Guaranty
	RT	450	RT
<b>Temp. (°C)</b>	RT	450	RT
<b>0.2%YS (MPa)</b>	490	360	462min.
<b>TS (MPa)</b>	590	450	552min.
<b>EI on 4d (%)</b>	30	24	19min.
<b>IV -18°C (J)</b>	200	-	-
<b>PWHT (°Cxh)</b>	690x1	690x1	690±15x1

**Approvals**

<b>LR</b>	MG
<b>BV</b>	UP (E8016-B2)



**Stick electrode for 1-1.25%Cr-0.5%Mo steel**

- Features:**
- Applied for ASTM A387 Gr.11, Gr.12 and equivalents
  - Lower TS, higher IV and less sensitive to temper embrittlement

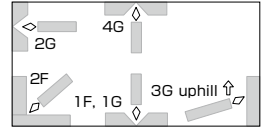
**Welding Positions:**

**Classification:** AWS A5.5 E8016-B2

**Redrying Conditions:** 325~375°Cx1h

**Identification color:** 1st Black, 2nd Silver grey

**Polarity:** DCEP

**Packaging data**

φ mm	Length mm	kg/pack	kg/carton	g/piece	carton mm
2.6	300	2	20	17	270W, 85H, 330L
3.2	350	5	20	30	170W, 110H, 380L
4.0	400	5	20	54	170W, 115H, 430L
5.0	400	5	20	84	170W, 110H, 430L
6.0	400	5	20	120	170W, 120H, 430L

**Composition (all-weld metal mass%)**

	Typical	Guaranty <sup>a</sup>
<b>C</b>	0.06	0.05~0.12
<b>Si</b>	0.47	0.60
<b>Mn</b>	0.79	0.90
<b>P</b>	0.01	0.03
<b>S</b>	<0.01	0.03
<b>Cr</b>	1.31	1.00~1.50
<b>Mo</b>	0.57	0.40~0.65

**Welding parameters (A)**

φ mm	1F, 1G, 2F, 2G	3G uphill, 4G
2.6	55~85	50~80
3.2	70~110	70~105
4.0	115~165	95~155
5.0	175~225	-
6.0	230~290	-

Note: <sup>a</sup> Single values are maximum.

**All-weld mechanical properties**

	Typical		Guaranty
	RT	450	RT
<b>0.2%YS (MPa)</b>	520	390	462min.
<b>TS (MPa)</b>	620	480	552min.
<b>El on 4d (%)</b>	27	19	19min.
<b>IV -20°C (J)</b>	170	-	-
<b>PWHT (°C×h)</b>	690x1	690x1	690±15x1

## Stick electrode for 1-1.25%Cr-0.5%Mo steel

**Features:** Applied for ASTM A387 Gr.11, Gr.12 and equivalents

**Classification:** AWS A5.5 E7015-B2L

**Redrying Conditions:** 325~375°Cx1h

**Identification color:** 1st Black, 2nd Yellow

**Polarity:** DCEP

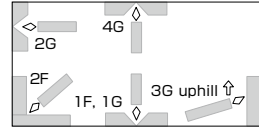
**Welding Positions:****Packaging data**

$\phi$ mm	Length mm	kg/pack	kg/carton	g/piece	carton mm
2.6	300	2	20	18	170W, 120H, 330L
3.2	350, 400	5	20	31, 36	170W, 120H, 380L or 430L
4.0	400	5	20	55	170W, 120H, 430L

**Composition (all-weld metal mass%)**

	Typical	Guaranty <sup>a</sup>
<b>C</b>	0.02	0.05
<b>Si</b>	0.93	1.00
<b>Mn</b>	0.74	0.90
<b>P</b>	0.01	0.03
<b>S</b>	<0.01	0.03
<b>Cr</b>	1.20	1.00~1.50
<b>Mo</b>	0.52	0.40~0.65

Note: <sup>a</sup>Single values are maximum.

**Welding parameters (A)**

$\phi$ mm	1F, 1G, 2F, 2G	3G uphill, 4G
2.6	70~100	60~90
3.2	110~140	100~130
4.0	150~180	120~160

**All-weld mechanical properties**

	Typical	Guaranty
<b>0.2%YS (MPa)</b>	470	393min.
<b>TS (MPa)</b>	580	518min.
<b>El on 4d (%)</b>	29	19min.
<b>IV 0°C (J)</b>	80	-
<b>PWHT (°Cxh)</b>	690x1	690±15x1

**Approvals**

LR	MG

## Stick electrode for 1-1.25%Cr-0.5%Mo steel

**Features:** Applied for ASTM A387 Gr.11, Gr.12 and equivalents

**Welding Positions:**

**Classification:** AWS A5.5 E8018-B2

**Redrying Conditions:** 325~375°Cx1h

**Identification color:** 1st Black, 2nd Yellowish green

**Polarity:** AC, DCEP

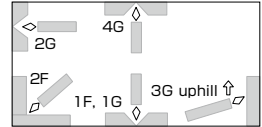
**Packaging data**

φ mm	Length mm	kg/pack	kg/carton	g/piece	carton mm
2.6	300	2	20	19	170W, 120H, 330L
3.2	400	5	20	38	170W, 120H, 430L
4.0	450	5	20	69	170W, 120H, 480L
5.0	450	5	20	106	170W, 120H, 480L
6.0	450	5	20	154	170W, 120H, 480L

**Composition (all-weld metal mass%)**

	Typical (AC)	Guaranty <sup>a</sup>
<b>C</b>	0.07	0.05~0.12
<b>Si</b>	0.73	0.80
<b>Mn</b>	0.78	0.90
<b>P</b>	0.01	0.03
<b>S</b>	<0.01	0.03
<b>Cr</b>	1.31	1.00~1.50
<b>Mo</b>	0.54	0.40~0.65

Note: <sup>a</sup> Single values are maximum.

**Welding parameters (A)**

φ mm	1F, 1G, 2F, 2G	3G uphill, 4G
2.6	65~95	60~90
3.2	90~130	80~120
4.0	135~185	110~170
5.0	190~250	-
6.0	250~320	-

**All-weld mechanical properties**

	Typical (AC)	Guaranty
<b>0.2%YS (MPa)</b>	590	462min.
<b>TS (MPa)</b>	690	552min.
<b>EI on 4d (%)</b>	26	19min.
<b>IV 0°C (J)</b>	70	-
<b>PWHT (°C×h)</b>	690x1	690±15x1

**Approvals**

LR	MG
----	----

## Stick electrode for 2.25%Cr-1%Mo steel

**Features:** Applied for ASTM A387 Gr.22 and equivalents

**Classification:** AWS A5.5 E9016-B3

**Redrying Conditions:** 325~375°Cx1h

**Identification color:** 1st Silver, 2nd Brown

**Polarity:** AC, DCEP

## Welding Positions:

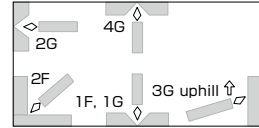

## Packaging data

φ mm	Length mm	kg/pack	kg/carton	g/piece	carton mm
2.6	300	2	20	17	270W, 85H, 330L
3.2	350	5	20	30	170W, 110H, 380L
4.0	400	5	20	55	170W, 105H, 430L
5.0	400	5	20	85	170W, 120H, 430L
6.0	400	5	20	121	170W, 120H, 430L

## Composition (all-weld metal mass%)

	Typical (AC)	Guaranty <sup>a</sup>
<b>C</b>	0.07	0.05~0.12
<b>Si</b>	0.44	0.60
<b>Mn</b>	0.63	0.90
<b>P</b>	0.01	0.03
<b>S</b>	<0.01	0.03
<b>Cr</b>	2.10	2.00~2.50
<b>Mo</b>	1.02	0.90~1.20

Note: <sup>a</sup> Single values are maximum.

## Welding parameters (A)

φ mm	1F, 1G, 2F, 2G	3G uphill, 4G
2.6	55~85	50~80
3.2	90~130	75~115
4.0	140~190	100~160
5.0	190~240	-
6.0	240~300	-

## All-weld mechanical properties

	Typical (AC)		Guaranty
<b>Temp. (°C)</b>	RT	450	RT
<b>0.2%YS (MPa)</b>	630	520	531min.
<b>TS (MPa)</b>	730	580	621min.
<b>El on 4d (%)</b>	22	17	17min.
<b>IV 0°C (J)</b>	120	-	-
<b>PWHT (°Cxh)</b>	690x1	690x1	690±15x1

## Approvals

<b>ABS</b>	MG (AWS A5.5 E9016-B3)
<b>LR</b>	MG
<b>DNV</b>	MG (VL2Cr1Mo), H10
<b>BV</b>	UP (E9016-B3)
<b>NK</b>	MG (AWS A5.5 E9016-B3)

**Stick electrode for 2.25%Cr-1%Mo steel**

- Features:**
- Applied for ASTM A387 Gr.22 and equivalents
  - Lower tensile strength, higher impact value and less sensitive to temper embrittlement

**Classification:** AWS A5.5 E9016-B3

**Redrying Conditions:** 325~375°Cx1h

**Identification color:** 1st Silver, 2nd White

**Polarity:** AC

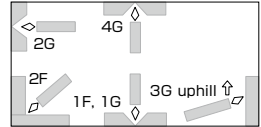
**Welding Positions:****Packaging data**

φ mm	Length mm	kg/pack	kg/carton	g/piece	carton mm
2.6	300	2	20	18	270W, 85H, 330L
3.2	350	5	20	31	170W, 115H, 380L
4.0	400	5	20	55	170W, 105H, 430L
5.0	400	5	20	86	170W, 115H, 430L
6.0	400	5	20	122	170W, 115H, 430L

**Composition (all-weld metal mass%)**

	Typical	Guaranty <sup>a</sup>
<b>C</b>	0.11	0.05~0.12
<b>Si</b>	0.38	0.60
<b>Mn</b>	0.76	0.90
<b>P</b>	<0.01	0.03
<b>S</b>	<0.01	0.03
<b>Cr</b>	2.25	2.00~2.50
<b>Mo</b>	1.02	0.90~1.20

Note: <sup>a</sup> Single values are maximum.

**Welding parameters (A)**

φ mm	1F, 1G, 2F, 2G	3G uphill, 4G
2.6	55~85	50~80
3.2	90~130	75~115
4.0	140~190	100~160
5.0	190~240	-
6.0	240~300	-

**All-weld mechanical properties**

	Typical		Guaranty
<b>Temp. (°C)</b>	RT	450	RT
<b>0.2%YS (MPa)</b>	510	430	531min.
<b>TS (MPa)</b>	650	510	631min.
<b>El on 4d (%)</b>	28	20	17min.
<b>IV -29°C (J)</b>	120	-	-
<b>PWHT (°Cxh)</b>	690x8	690x8	690±15x1

**Approvals**

BV	UP (E9016-B3)

## Stick electrode for 2.25%Cr-1%Mo steel

- Features:**
- Applied for ASTM A387 Gr.22 and equivalents
  - Lower tensile strength, higher impact value and less sensitive to temper embrittlement

**Classification:** AWS A5.5 E9016-B3

**Redrying Conditions:** 325~375°Cx1h

**Identification color:** 1st Black, 2nd White

**Polarity:** DCEP

## Welding Positions:

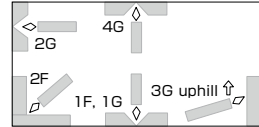

## Packaging data

φ mm	Length mm	kg/pack	kg/carton	g/piece	carton mm
3.2	350	5	20	31	170W, 120H, 380L
4.0	400	5	20	55	170W, 105H, 430L
5.0	400	5	20	86	170W, 115H, 430L

## Composition (all-weld metal mass%)

	Typical	Guaranty <sup>a</sup>
<b>C</b>	0.09	0.05~0.12
<b>Si</b>	0.24	0.60
<b>Mn</b>	0.67	0.90
<b>P</b>	<0.01	0.03
<b>S</b>	<0.01	0.03
<b>Cr</b>	2.21	2.00~2.50
<b>Mo</b>	1.02	0.90~1.20

## Welding parameters (A)

φ mm	1F, 1G, 2F, 2G	3G uphill, 4G
3.2	90~130	75~115
4.0	140~190	100~160
5.0	190~240	-

Note: <sup>a</sup> Single values are maximum.

## All-weld mechanical properties

	Typical		Guaranty
<b>Temp. (°C)</b>	RT	450	RT
<b>0.2%YS (MPa)</b>	500	400	531min.
<b>TS (MPa)</b>	640	480	621min.
<b>EI on 4d (%)</b>	26	19	17min.
<b>IV -40°C (J)</b>	150	-	-
<b>PWHT (°Cxh)</b>	690x8	690x8	690±15x1

## Stick electrode for 2.25%Cr-1%Mo steel

**Features:** Applied for ASTM A387 Gr.22 and equivalents

**Classification:** AWS A5.5 E8015-B3L

**Redrying Conditions:** 325~375°Cx1h

**Identification color:** 1st Black, 2nd Blue

**Polarity:** DCEP

## Welding Positions:

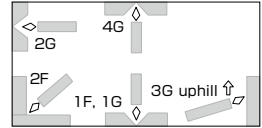

## Packaging data

$\phi$ mm	Length mm	kg/pack	kg/carton	g/piece	carton mm
3.2	350	5	20	32	170W, 120H, 380L
4.0	400	5	20	56	170W, 120H, 430L
5.0	400	5	20	87	170W, 120H, 430L

## Composition (all-weld metal mass%)

	Typical	Guaranty <sup>a</sup>
<b>C</b>	0.03	0.05
<b>Si</b>	0.90	1.00
<b>Mn</b>	0.79	0.90
<b>P</b>	0.01	0.03
<b>S</b>	<0.01	0.03
<b>Cr</b>	2.20	2.00~2.50
<b>Mo</b>	0.98	0.90~1.20

Note: <sup>a</sup>Single values are maximum.

## Welding parameters (A)

$\phi$ mm	1F, 1G, 2F, 2G	3G uphill, 4G
3.2	110~140	100~130
4.0	150~180	120~160
5.0	190~220	-

## All-weld mechanical properties

	Typical	Guaranty
<b>0.2%YS (MPa)</b>	550	462min.
<b>TS (MPa)</b>	650	552min.
<b>El on 4d (%)</b>	25	17min.
<b>IV 0°C (J)</b>	80	-
<b>PWHT (°Cxh)</b>	690x1	690±15x1

## Stick electrode for 2.25%Cr-1%Mo steel

**Features:** Applied for ASTM A387 Gr.22 and equivalents

**Classification:** AWS A5.5 E9018-B3

**Redrying Conditions:** 325~375°Cx1h

**Identification color:** 1st Black, 2nd Pink

**Polarity:** AC, DCEP

## Welding Positions:

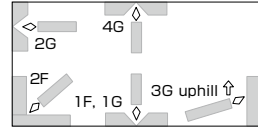

## Packaging data

φ mm	Length mm	kg/pack	kg/carton	g/piece	carton mm
2.6	300	2	20	19	170W, 120H, 330L
3.2	400	5	20	40	170W, 120H, 430L
4.0	450	5	20	69	170W, 120H, 480L
5.0	450	5	20	108	170W, 120H, 480L

## Composition (all-weld metal mass%)

	Typical (AC)	Guaranty <sup>a</sup>
<b>C</b>	0.07	0.05~0.12
<b>Si</b>	0.72	0.80
<b>Mn</b>	0.72	0.90
<b>P</b>	0.01	0.03
<b>S</b>	0.01	0.03
<b>Cr</b>	2.23	2.00~2.50
<b>Mo</b>	0.97	0.90~1.20

Note: <sup>a</sup> Single values are maximum.

## Welding parameters (A)

φ mm	1F, 1G, 2F, 2G	3G uphill, 4G
2.6	65~95	60~90
3.2	90~130	80~120
4.0	135~185	110~170
5.0	190~250	-

## All-weld mechanical properties

	Typical (AC)	Guaranty
<b>0.2%YS (MPa)</b>	610	531min.
<b>TS (MPa)</b>	720	621min.
<b>EI on 4d (%)</b>	23	17min.
<b>IV 0°C (J)</b>	110	-
<b>PWHT (°Cxh)</b>	690x1	690±15x1



## Stick electrode for 2.25%Cr-1%Mo-V steel

- Features:**
- Applied for ASTM A542 Type D Cl.4a and equivalents
  - Excellent tensile strength at high temperatures and less sensitive to temper embrittlement

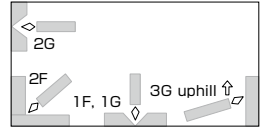
**Welding Positions:**

**Classification:** AWS A5.5 E9016-G

**Redrying Conditions:** 325~375°Cx1h

**Identification color:** 1st Silver, 2nd Green

**Polarity:** AC

**Packaging data**

φ mm	Length mm	kg/pack	kg/carton	g/piece	carton mm
3.2	350	5	20	32	170W, 115H, 380L
4.0	400	5	20	56	170W, 110H, 430L
5.0	400	5	20	87	170W, 120H, 430L

**Composition (all-weld metal mass%)**

	Typical	Guaranty <sup>a</sup>
<b>C</b>	0.09	0.05~0.12
<b>Si</b>	0.28	0.20~0.50
<b>Mn</b>	0.87	0.50~1.30
<b>P</b>	0.01	0.03
<b>S</b>	<0.01	0.03
<b>Cr</b>	2.13	2.00~2.60
<b>Mo</b>	1.03	0.90~1.20
<b>V</b>	0.39	0.20~0.40
<b>Nb</b>	0.018	0.010~0.040

Note: <sup>a</sup>Single values are maximum.

**Welding parameters (A)**

φ mm	1F, 1G, 2F, 2G	3G uphill
3.2	90~130	75~115
4.0	140~190	100~160
5.0	190~240	-

**All-weld mechanical properties**

	Typical	Guaranty
<b>0.2%YS (MPa)</b>	620	531min.
<b>TS (MPa)</b>	730	621min.
<b>EI on 4d (%)</b>	24	17min.
<b>IV -18°C (J)</b>	140	-
<b>PWHT (°Cxh)</b>	705°C×8h	705±15x8

## Stick electrode for 2.25%Cr-1%Mo-V steel

- Features:**
- Applied for ASTM A542 Type D Cl.4a and equivalents
  - Excellent tensile strength at high temperatures and less sensitive to temper embrittlement

**Classification:** AWS A5.5 E9016-G

**Redrying Conditions:** 325~375°Cx1h

**Identification color:** 1st Silver, 2nd Green

**Polarity:** DCEP

## Welding Positions:

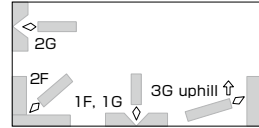

## Packaging data

φ mm	Length mm	kg/pack	kg/carton	g/piece	carton mm
3.2	350	5	20	32	170W, 120H, 380L
4.0	400	5	20	56	170W, 110H, 430L
5.0	400	5	20	87	170W, 120H, 430L

## Composition (all-weld metal mass%)

	Typical	Guaranty <sup>a</sup>
<b>C</b>	0.07	0.05~0.12
<b>Si</b>	0.24	0.20~0.50
<b>Mn</b>	0.87	0.50~1.30
<b>P</b>	<0.01	0.03
<b>S</b>	<0.01	0.03
<b>Cr</b>	2.34	2.00~2.60
<b>Mo</b>	1.01	0.90~1.20
<b>V</b>	0.30	0.20~0.40
<b>Nb</b>	0.018	0.010~0.040

## Welding parameters (A)

φ mm	1F, 1G, 2F, 2G	3G uphill
3.2	90~130	75~115
4.0	140~190	100~160
5.0	190~240	-

Note: <sup>a</sup> Single values are maximum.

## All-weld mechanical properties

	Typical	Guaranty
<b>0.2%YS (MPa)</b>	600	531min.
<b>TS (MPa)</b>	710	621min.
<b>EI on 4d (%)</b>	21	17min.
<b>IV -18°C (J)</b>	120	-
<b>PWHT (°C×h)</b>	705x8	705±15x8

**Stick electrode for low C-2.25%Cr-W-V-Nb steel**

**Features:**                      • Applied for ASTM A335 Gr. P23 and equivalents

**Classification:**            AWS A5.5 E9016-G

**Redrying Conditions:** 325~375°Cx1h

**Identification color:**    1st Orange, 2nd Green

**Polarity:**                      AC, DCEP

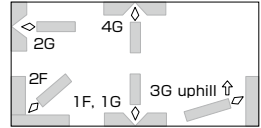
**Welding Positions:****Packaging data**

φ mm	Length mm	kg/pack	kg/carton	g/piece	carton mm
2.6	300	2	20	17	270W, 85H, 330L
3.2	350	5	20	31	170W, 120H, 380L
4.0	400	5	20	57	170W, 120H, 430L
5.0	400	5	20	86	170W, 120H, 430L

**Composition (all-weld metal mass%)**

	Typical (AC)	Guaranty <sup>a</sup>
<b>C</b>	0.05	0.15
<b>Si</b>	0.36	0.60
<b>Mn</b>	0.82	0.10~1.60
<b>P</b>	0.007	0.020
<b>S</b>	0.004	0.010
<b>Ni</b>	0.04	0.01~1.20
<b>Cr</b>	2.25	1.90~2.60
<b>Mo</b>	0.08	0.05~0.85
<b>Cu</b>	0.02	0.40
<b>W</b>	1.45	1.00~2.00
<b>V</b>	0.22	0.15~0.30
<b>Nb</b>	0.02	0.01~0.08

Note: <sup>a</sup> Single values are maximum.

**Welding parameters (A)**

φ mm	1F, 1G, 2F, 2G	3G uphill, 4G
2.6	55~85	50~80
3.2	75~115	70~110
4.0	120~160	90~150
5.0	190~240	-

**All-weld mechanical properties**

	Typical (AC)	Guaranty
<b>0.2%YS (MPa)</b>	570	295min.
<b>TS (MPa)</b>	650	510min.
<b>El on 4d (%)</b>	20	17min.
<b>IV 0°C (J)</b>	110	-
<b>PWHT (°Cxh)</b>	715x2	715±15x2

**Approvals**

<b>ABS</b>	MG
<b>LR</b>	MG
<b>NK</b>	MG

## Stick electrode for 9%Cr-1%Mo-V-Nb steel

- Features:**
- Applied for ASTM A387 Gr.91 and equivalents
  - Excellent creep rupture strength

**Classification:** AWS A5.5 E9015-B91

**Redrying Conditions:** 325~375°Cx1h

**Identification color:** -

**Polarity:** DCEP

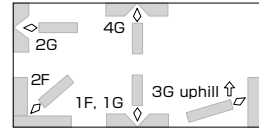
**Welding Positions:****Packaging data**

φ mm	Length mm	kg/pack	kg/carton	g/piece	carton mm
2.5/2.6	300	2	20	18	270W, 85H, 330L
3.2	350	5	20	31	170W, 120H, 380L
4.0	350, 400	5	20	48, 55	170W, 115H, 430L

**Composition (all-weld metal mass%)**

	Typical	Guaranty <sup>a</sup>
<b>C</b>	0.09	0.08~0.13
<b>Si</b>	0.23	0.30
<b>Mn</b>	0.71	1.20
<b>P</b>	0.01	0.01
<b>S</b>	<0.01	0.01
<b>Ni</b>	0.10	0.80
<b>Co</b>	0.42	-
<b>Cr</b>	8.4	8.0~10.5
<b>Mo</b>	0.99	0.85~1.20
<b>Nb</b>	0.06	0.02~0.10
<b>V</b>	0.21	0.15~0.30
<b>Cu</b>	0.03	-
<b>Al</b>	<0.01	0.04
<b>N</b>	0.03	0.02~0.07
<b>Mn+Ni</b>	0.81	1.40

Note: <sup>a</sup> Single values are maximum.

**Welding parameters (A)**

φ mm	1F, 1G, 2F, 2G	3G uphill, 4G
2.5/2.6	55~90	50~80
3.2	75~115	70~110
4.0	120~160	90~150

**All-weld mechanical properties**

	Typical	Guaranty
<b>0.2%YS (MPa)</b>	590	531min.
<b>TS (MPa)</b>	730	621min.
<b>El on 4d (%)</b>	21	17min.
<b>IV 20°C (J)</b>	70	-
<b>PWHT (°C×h)</b>	760x2	760±15x2

**CM-96B91****Stick electrode for 9%Cr-1%Mo-V-Nb steel**

**Features:**

- Applied for ASTM A387 Gr.91 and equivalents
- Excellent creep rupture strength

**Classification:** AWS A5.5 E9016-B91

**Redrying Conditions:** 325~375°Cx1h

**Identification color:** -

**Polarity:** AC

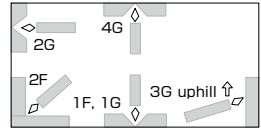
**Welding Positions:****Packaging data**

φ mm	Length mm	kg/pack	kg/carton	g/piece	carton mm
2.6	300	2	20	18	270W, 85H, 330L
3.2	350	5	20	31	170W, 120H, 380L
4.0	400	5	20	55	170W, 115H, 430L

**Composition (all-weld metal mass%)**

	Typical	Guaranty <sup>a</sup>
<b>C</b>	0.11	0.08~0.13
<b>Si</b>	0.25	0.30
<b>Mn</b>	0.78	1.20
<b>P</b>	0.01	0.01
<b>S</b>	<0.01	0.01
<b>Ni</b>	0.15	0.80
<b>Co</b>	0.41	-
<b>Cr</b>	8.5	8.0~10.5
<b>Mo</b>	0.97	0.85~1.20
<b>Nb</b>	0.04	0.02~0.10
<b>V</b>	0.23	0.15~0.30
<b>Cu</b>	0.02	0.25
<b>Al</b>	<0.01	0.04
<b>N</b>	0.04	0.02~0.07
<b>Mn+Ni</b>	0.93	1.40

**Welding parameters (A)**

φ mm	1F, 1G, 2F, 2G	3G uphill, 4G
2.6	55~85	50~80
3.2	75~115	70~110
4.0	120~160	90~150

Note: <sup>a</sup> Single values are maximum.

**All-weld mechanical properties**

	Typical	Guaranty
<b>0.2%YS (MPa)</b>	620	531min.
<b>TS (MPa)</b>	760	621min.
<b>El on 4d (%)</b>	23	17min.
<b>IV 20°C (J)</b>	40	-
<b>PWHT (°Cxh)</b>	760x2	760±15x2

## Stick electrode for 9%Cr-1%Mo-V-Nb steel

- Features:**
- Applied for ASTM A387 Gr.91 and equivalents
  - Excellent creep rupture strength
  - Good performance by AC current

**Classification:** AWS A5.5 E9016-G

**Redrying Conditions:** 325~375°Cx1h

**Identification color:** 1st Yellow, 2nd Purple

**Polarity:** AC, DCEP

## Welding Positions:

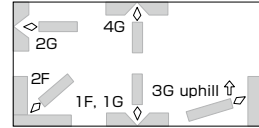

## Packaging data

φ mm	Length mm	kg/pack	kg/carton	g/piece	carton mm
2.6	300	2	20	18	270W, 85H, 330L
3.2	350	5	20	31	170W, 115H, 380L
4.0	400	5	20	55	170W, 105H, 430L
5.0	400	5	20	85	170W, 110H, 430L

## Composition (all-weld metal mass%)

	Typical (AC)	Guaranty <sup>a</sup>
<b>C</b>	0.07	0.12
<b>Si</b>	0.39	0.60
<b>Mn</b>	1.51	2.00
<b>P</b>	0.01	0.03
<b>S</b>	<0.01	0.03
<b>Ni</b>	0.94	1.00
<b>Cr</b>	8.98	8.00~10.50
<b>Mo</b>	1.06	0.80~1.20
<b>Nb</b>	0.03	0.15
<b>V</b>	0.19	0.50

Note: <sup>a</sup>Single values are maximum.

## Welding parameters (A)

φ mm	1F, 1G, 2F, 2G	3G uphill, 4G
2.6	55~85	50~80
3.2	75~115	70~110
4.0	120~160	90~150
5.0	160~220	-

## All-weld mechanical properties

	Typical (AC)	Guaranty
<b>0.2%YS (MPa)</b>	600	531min.
<b>TS (MPa)</b>	750	621min.
<b>El on 4d (%)</b>	25	17min.
<b>IV 0°C (J)</b>	80	-
<b>PWHT (°C×h)</b>	750x5	740±15x1

## Approvals

<b>ABS</b>	MG (AWS A5.5 E9016-G)
<b>LR</b>	MG
<b>NK</b>	MG

**Stick electrode for 9-12%Cr-W-V-Nb steel**

**Features:**

- Applied for ASTM A335 Gr. P92 and equivalents
- Excellent creep rupture strength

**Classification:** AWS A5.5 E9016-G

**Redrying Conditions:** 325~375°Cx1h

**Identification color:** -

**Polarity:** DCEP, AC

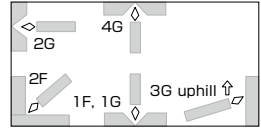
**Welding Positions:****Packaging data**

φ mm	Length mm	kg/pack	kg/carton	g/piece	carton mm
3.2	350	5	20	31	170W, 120H, 380L
4.0	400	5	20	55	170W, 110H, 430L
5.0	400	5	20	85	170W, 120H, 430L

**Composition (all-weld metal mass%)**

	Typical (DCEP)	Guaranty <sup>a</sup>
<b>C</b>	0.07	0.15
<b>Si</b>	0.38	0.60
<b>Mn</b>	0.94	0.50~1.50
<b>P</b>	0.01	0.03
<b>S</b>	<0.01	0.03
<b>Ni</b>	0.46	1.50
<b>Co</b>	1.57	0.50~1.80
<b>Cr</b>	9.52	8.60~13.00
<b>Mo</b>	0.21	0.50
<b>V</b>	0.30	0.50
<b>Nb</b>	0.030	0.080
<b>W</b>	1.56	1.30~2.50

Note: <sup>a</sup> Single values are maximum.

**Welding parameters (A)**

φ mm	1F, 1G, 2F, 2G	3G uphill, 4G
2.6	55~85	50~80
3.2	75~115	70~110
4.0	120~160	90~150
5.0	160~220	-

**All-weld mechanical properties**

	Typical (DCEP)	Guaranty
<b>0.2%YS (MPa)</b>	650	531min.
<b>TS (MPa)</b>	700	621min.
<b>El on 4d (%)</b>	22	17min.
<b>IV 0°C (J)</b>	40	-
<b>PWHT (°Cxh)</b>	740x8	750±15x8

**Solid wire for Mn-Mo & Mn-Mo-Ni steel**

**Features:**     - Applied for ASTM A533 Type A, B, C, D and equivalents

**Classification:** AWS A5.28 ER80S-G

**Shielding gas:** Ar-5~20%CO<sub>2</sub>

**Polarity:**       DCEP

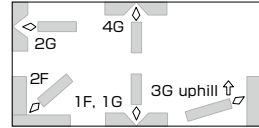
**Welding Positions:****Packaging data**

$\phi$ mm	Spool
1.2	20kg
<b>Volume mm</b>	280W, 110H, 270L

**Composition (wire mass%)**

	Typical	Guaranty <sup>a</sup>
<b>C</b>	0.06	0.10
<b>Si</b>	0.41	0.30~0.90
<b>Mn</b>	1.50	1.00~1.60
<b>P</b>	0.004	0.020
<b>S</b>	0.007	0.020
<b>Ni</b>	0.92	0.50~1.00
<b>Mo</b>	0.35	0.20~0.60
<b>Cu</b>	0.16	0.35

Note: <sup>a</sup> Single values are maximum.

**Welding parameters (A)**

$\phi$ mm	1F, 1G, 2F	2G, 3G uphill, 4G
1.2	240~300	130~190

**All-weld mechanical properties**

	Typical	Guaranty
<b>0.2%YS (MPa)</b>	540	469min.
<b>TS (MPa)</b>	620	552min.
<b>EI on 4d (%)</b>	29	19min.
<b>IV -20°C (J)</b>	190	-
<b>PWHT (°C<sub>x</sub>h)</b>	620x1	620±15x1
<b>SG</b>	Ar-20%CO <sub>2</sub>	Ar-20%CO <sub>2</sub>



**Solid wire for Mn-Mo & Mn-Mo-Ni steel**

**Features:** • Applied for ASTM A533 Type A, B, C, D class 2 and equivalents

**Classification:** AWS A5.28 ER90S-G

**Shielding gas:** Ar-5~20%CO<sub>2</sub>

**Polarity:** DCEP

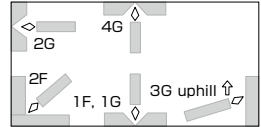
**Welding Positions:****Packaging data**

$\phi$ mm	Spool
1.2	20kg
<b>Volume mm</b>	280W, 110H, 270L

**Composition (wire mass%)**

	Typical	Guaranty <sup>a</sup>
<b>C</b>	0.08	0.15
<b>Si</b>	0.48	0.70
<b>Mn</b>	1.76	1.50~2.10
<b>P</b>	0.007	0.015
<b>S</b>	0.002	0.015
<b>Ni</b>	1.02	0.80~1.40
<b>Mo</b>	0.46	0.40~0.65
<b>Cu</b>	0.12	0.35

Note: <sup>a</sup> Single values are maximum.

**Welding parameters (A)**

$\phi$ mm	1F, 1G, 2F	2G, 3G uphill, 4G
1.2	240~300	130~190

**All-weld mechanical properties**

	Typical	Guaranty
<b>0.2%YS (MPa)</b>	570	-
<b>TS (MPa)</b>	650	621min.
<b>EI on 4d (%)</b>	27	-
<b>IV -12°C (J)</b>	150	-
<b>PWHT (°Cxh)</b>	630x27	620±15x1
<b>SG</b>	Ar-20%CO <sub>2</sub>	Ar-20%CO <sub>2</sub>

# MG-S70SA1

**Solid wire for 0.5%Mo steel**

**Features:** - Applied for ASTM A204 Gr. A, B, C and equivalents

**Classification:** AWS A5.28 ER70S-A1

**Shielding gas:** Ar-2~5%O<sub>2</sub>, Ar-5~20%CO<sub>2</sub>

**Polarity:** DCEP

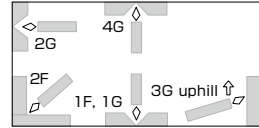
**Welding Positions:****Packaging data**

φ mm	Spool		Drum	
	Weight	Length	Weight	Length
0.9	10kg	-	-	-
1.0	-	20kg	250kg	-
1.2	-	20kg	250kg	400kg
<b>Volume mm</b>	240W, 110H, 230L	280W, 110H, 270L	530 φ, 820H	680 φ, 770H

**Composition (wire mass%)**

	Typical	Guaranty <sup>a</sup>
<b>C</b>	0.04	0.12
<b>Si</b>	0.51	0.30~0.70
<b>Mn</b>	0.99	1.30
<b>P</b>	0.009	0.025
<b>S</b>	0.012	0.025
<b>Ni</b>	0.03	0.20
<b>Mo</b>	0.49	0.40~0.65
<b>Cu</b>	0.16	0.35

**Welding parameters (A)**

φ mm	1F, 1G, 2F	2G, 3G uphill, 4G
1.2	240~300	130~190

Note: <sup>a</sup>Single values are maximum.

**All-weld mechanical properties**

	Typical	Guaranty
<b>0.2%YS (MPa)</b>	450	400min.
<b>TS (MPa)</b>	530	515min.
<b>EI on 4d (%)</b>	33	19min.
<b>IV 0°C (J)</b>	190	-
<b>PWHT (°C×h)</b>	620x1	620±15x1
<b>SG</b>	Ar-2%O <sub>2</sub>	Ar-2%O <sub>2</sub>

**Solid wire for 0.5%Mo steel**

**Features:**      • Applied for ASTM A204 Gr. A, B, C and equivalents

**Classification:** AWS A5.28 ER80S-G

**Shielding gas:** Ar-2~5%O<sub>2</sub>, Ar-5~20%CO<sub>2</sub>

**Polarity:**        DCEP

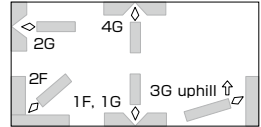
**Welding Positions:****Packaging data**

φ mm	Spool		Drum		
	10kg	20kg	-	-	-
0.9	10kg	20kg	-	-	-
1.0	10kg	20kg	-	-	-
1.2	10kg	20kg	100kg	250kg	400kg
<b>Volume mm</b>	240W, 110H, 230L	280W, 110H, 270L	530 φ, 820H		680 φ, 770H

**Composition (wire mass%)**

	Typical	Guaranty <sup>a</sup>
<b>C</b>	0.07	0.12
<b>Si</b>	0.53	0.30~0.70
<b>Mn</b>	1.03	0.60~1.30
<b>P</b>	0.006	0.025
<b>S</b>	0.008	0.025
<b>Ni</b>	0.02	0.20
<b>Mo</b>	0.54	0.40~0.65
<b>Cu</b>	0.17	0.35

**Welding parameters (A)**

φ mm	1F, 1G, 2F	2G, 3G uphill, 4G
1.2	240~300	130~190

Note: <sup>a</sup> Single values are maximum.

**All-weld mechanical properties**

	Typical		Guaranty
	<b>0.2%YS (MPa)</b>	520	480
<b>TS (MPa)</b>	610	580	552min.
<b>El on 4d (%)</b>	25	28	19min.
<b>IV 0°C (J)</b>	100	160	-
<b>PWHT (°C×h)</b>	AW	620x1	AW
<b>SG</b>	Ar-20%CO <sub>2</sub>	Ar-20%CO <sub>2</sub>	Ar-20%CO <sub>2</sub>

**Approvals**

<b>ABS</b>	MG (AWS A5.28 ER80S-G)
<b>LR</b>	MG

# MG-S1CM

**Solid wire for 1-1.25%Cr-0.5%Mo steel**

**Features:** - Applied for ASTM A387 Gr.11, Gr.12 and equivalents

**Classification:** AWS A5.28 ER80S-B2Mn

**Shielding gas:** Ar-2~5%O<sub>2</sub>, Ar-5~20%CO<sub>2</sub>

**Polarity:** DCEP

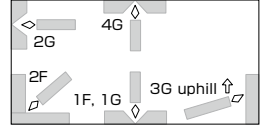
**Welding Positions:****Packaging data**

φ mm	Spool		Drum		
	kg	kg	kg	kg	kg
0.8	10kg	-	-	-	-
0.9	10kg	-	-	-	-
1.0	10kg	20kg	-	-	-
1.2	10kg	20kg	250kg	300kg	400kg
1.4	10kg	-	-	-	-
1.6	-	20kg	-	-	400kg
<b>Volume mm</b>	240W, 110H, 230L	280W, 110H, 270L	530 φ, 820H		680 φ, 770H

**Composition (wire mass%)**

	Typical	Guaranty <sup>a</sup>
<b>C</b>	0.07	0.12
<b>Si</b>	0.55	0.30~0.90
<b>Mn</b>	1.05	0.80~1.50
<b>P</b>	0.007	0.025
<b>S</b>	0.008	0.025
<b>Cr</b>	1.38	1.00~1.60
<b>Mo</b>	0.56	0.40~0.65
<b>Cu</b>	0.26	0.40

Note: <sup>a</sup>Single values are maximum.

**Welding parameters (A)**

φ mm	1F, 1G, 2F	2G, 3G uphill, 4G
1.2	240~300	130~190

**All-weld mechanical properties**

	Typical		Guaranty
	MPa	MPa	
<b>0.2%YS (MPa)</b>	550	570	469min.
<b>TS (MPa)</b>	640	680	552min.
<b>El on 4d (%)</b>	25	22	17min.
<b>IV 0°C (J)</b>	190	70	-
<b>PWHT (°C×h)</b>	650x1	620x1	620±15x1
<b>SG</b>	Ar-2%O <sub>2</sub>	Ar-20%CO <sub>2</sub>	Ar-2%O <sub>2</sub>

**Approvals**

<b>ABS</b>	MG
<b>LR</b>	MG
<b>BV</b>	UP
	(AWS A 5.28 ER80S-G)
<b>NK</b>	MG

**Solid wire for 1-1.25%Cr-0.5%Mo steel**

- Features:**
- Applied for ASTM A387 Gr.11 and equivalents
  - Suitable for 1 pass fillet welding in the panel fin tube fabrication
  - Do not use for multi-pass welding

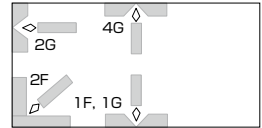
**Welding Positions:**

**Classification:** AWS A5.28 ER80S-B2

**Shielding gas:** Ar-2~5%O<sub>2</sub>, Ar-5~20%CO<sub>2</sub> mixture

**Polarity:** DCEP

**Packaging data**

φ mm	Spool		Drum	
	Weight	Length	Weight	Length
0.9	10kg	20kg	-	-
1.0	10kg	20kg	250kg	-
1.2	10kg	20kg	250kg	400kg
1.4	10kg	20kg	-	-
1.6	10kg	20kg	-	400kg
<b>Volume mm</b>	240W, 110H, 230L	280W, 110H, 270L	530 φ, 820H	680 φ, 770H

**Composition (wire mass%)**

	Typical	Guaranty <sup>a</sup>
<b>C</b>	0.11	0.07~0.12
<b>Si</b>	0.50	0.40~0.70
<b>Mn</b>	0.67	0.47~0.70
<b>P</b>	0.004	0.025
<b>S</b>	0.004	0.025
<b>Cr</b>	1.40	1.20~1.50
<b>Ni</b>	0.01	0.20
<b>Mo</b>	0.55	0.40~0.65
<b>Cu</b>	0.15	0.35

Note: <sup>a</sup>Single values are maximum.

**Welding parameters (A)**

φ mm	1F, 1G, 2F	2G, 4G
1.2	240~300	130~190

**All-weld mechanical properties**

	Typical	Guaranty
<b>0.2%YS (MPa)</b>	550	470min.
<b>TS (MPa)</b>	650	550min.
<b>EI on 4d (%)</b>	28	19min.
<b>IV -18°C (J)</b>	140	-
<b>PWHT (°Cxh)</b>	620x1	620±15x1
<b>SG</b>	Ar-2%O <sub>2</sub>	Ar-2%O <sub>2</sub>

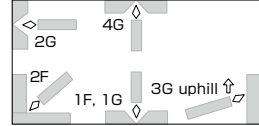
**Solid wire for 2.25%Cr-1%Mo steel****Features:** - Applied for ASTM A387 Gr.22 and equivalents**Classification:** AWS A5.28 ER90S-B3MnSi**Shielding gas:** Ar-2~5%O<sub>2</sub>, Ar-5~20%CO<sub>2</sub>**Polarity:** DCEP**Welding Positions:****Packaging data**

φ mm	Spool		Drum		
	kg	kg	kg	kg	kg
0.9	10kg	-	-	-	-
1.0	10kg	-	-	-	-
1.2	10kg	20kg	100kg	250kg	400kg
1.4	-	20kg	-	250kg	-
1.6	-	20kg	-	-	400kg
<b>Volume mm</b>	240W, 110H, 230L	280W, 110H, 270L	530 φ, 820H		680 φ, 770H

**Composition (wire mass%)**

	Typical	Guaranty <sup>a</sup>
<b>C</b>	0.07	0.12
<b>Si</b>	0.56	0.30~0.90
<b>Mn</b>	1.03	0.75~1.40
<b>P</b>	0.005	0.025
<b>S</b>	0.008	0.025
<b>Cr</b>	2.35	2.10~2.70
<b>Mo</b>	1.11	0.90~1.20
<b>Cu</b>	0.17	0.40

Note: <sup>a</sup>Single values are maximum.**Welding parameters (A)**

φ mm	1F, 1G, 2F	2G, 3G uphill, 4G
1.2	240~300	130~190

**All-weld mechanical properties**

	Typical		Guaranty
	MPa	MPa	
<b>0.2%YS (MPa)</b>	580	430	538min.
<b>TS (MPa)</b>	680	570	621min.
<b>EI on 4d (%)</b>	23	30	17min.
<b>IV 0°C (J)</b>	190	140	-
<b>PWHT (°C×h)</b>	690x1	690x15	690±15x1
<b>SG</b>	Ar-2%O <sub>2</sub>	Ar-20%CO <sub>2</sub>	Ar-2%O <sub>2</sub>

**Approvals**

<b>LR</b>	MG
<b>NK</b>	MG

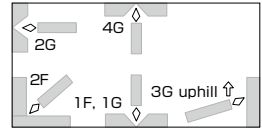
**Solid wire for low C-2.25%Cr-W-V-Nb steel****Features:** • Applied for ASTM A335 Gr. P23 and equivalents**Classification:** AWS A5.28 ER90S-G**Shielding gas:** Ar-5~20%CO<sub>2</sub>**Polarity:** DCEP**Welding Positions:****Packaging data**

φ mm	Spool	Drum
1.0	10kg	-
1.2	10kg	250kg
<b>Volume mm</b>	240W, 110H, 230L	530 φ, 820H

**Composition (wire mass%)**

	Typical	Guaranty <sup>a</sup>
<b>C</b>	0.04	0.12
<b>Si</b>	0.38	0.10~0.60
<b>Mn</b>	1.16	0.80~1.60
<b>P</b>	0.003	0.020
<b>S</b>	0.007	0.010
<b>Ni</b>	0.55	0.30~1.00
<b>Cr</b>	2.24	2.00~2.60
<b>Mo</b>	0.10	0.05~0.30
<b>Cu</b>	0.13	0.40
<b>Nb</b>	0.04	0.01~0.08
<b>V</b>	0.27	0.15~0.30
<b>W</b>	1.80	1.00~2.00

Note: <sup>a</sup>Single values are maximum.**Welding parameters (A)**

φ mm	1F, 1G, 2F	2G, 3G uphill, 4G
1.2	240~300	130~190

**All-weld mechanical properties**

	Typical	Guaranty
<b>0.2%YS (MPa)</b>	660	490min.
<b>TS (MPa)</b>	730	621min.
<b>El on 4d (%)</b>	19	15min.
<b>IV 0°C (J)</b>	40	-
<b>PWHT (°C×h)</b>	715x2	715x2
<b>SG</b>	Ar-20%CO <sub>2</sub>	Ar-20%CO <sub>2</sub>

**Approvals**

<b>LR</b>	MG
<b>NK</b>	MG

# MG-S90B91

**Solid wire for 9%Cr-1%Mo-V-Nb steel**

**Features:**

- Applied for ASTM A387 Gr.91 and equivalents
- Excellent creep rupture strength

**Classification:** AWS A5.28 ER90S-B91

**Shielding gas:** Ar-2~5%O<sub>2</sub>, Ar-5~20%CO<sub>2</sub>

**Polarity:** DCEP

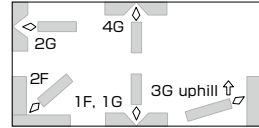
**Welding Positions:****Packaging data**

φ mm	Spool	
1.2	10kg	20kg
<b>Volume mm</b>	240W, 110H, 230L	280W, 110H, 270L

**Composition (wire mass%)**

	Typical	Guaranty <sup>a</sup>
<b>C</b>	0.12	0.07~0.13
<b>Si</b>	0.23	0.15~0.50
<b>Mn</b>	0.63	1.20
<b>P</b>	0.004	0.010
<b>S</b>	0.005	0.010
<b>Ni</b>	0.15	0.80
<b>Co</b>	0.41	-
<b>Cr</b>	8.38	8.00~10.50
<b>Mo</b>	0.98	0.85~1.20
<b>Cu</b>	0.01	0.20
<b>Nb</b>	0.06	0.02~0.10
<b>V</b>	0.18	0.15~0.30
<b>N</b>	0.04	0.03~0.07
<b>Al</b>	<0.01	0.04
<b>Mn+Ni</b>	0.78	1.50

Note: <sup>a</sup> Single values are maximum.

**Welding parameters (A)**

φ mm	1F, 1G, 2F	2G, 3G uphill, 4G
1.2	260~320	140~200

**All-weld mechanical properties**

	Typical	Guaranty
<b>0.2%YS (MPa)</b>	590	414min.
<b>TS (MPa)</b>	730	621min.
<b>EI on 4d (%)</b>	23	15min.
<b>IV 0°C (J)</b>	30	-
<b>PWHT (°C×h)</b>	760x2	760±15x2
<b>SG</b>	Ar-5%CO <sub>2</sub>	Ar-5%CO <sub>2</sub>

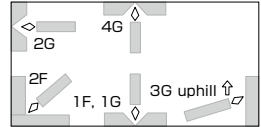

**Solid wire for 9%Cr-1%Mo-V-Nb steel****Features:** • Applied for ASTM A387 Gr.91 and equivalents**Classification:** AWS A5.28 ER90S-B91CMn**Shielding gas:** Ar-2~5%O<sub>2</sub>, Ar-5~20%CO<sub>2</sub>**Polarity:** DCEP**Welding Positions:****Packaging data**

φ mm	Spool	
1.0	10kg	-
1.2	10kg	20kg
<b>Volume mm</b>	240W, 110H, 230L	280W, 110H, 270L

**Composition (wire mass%)**

	Typical	Guaranty <sup>a</sup>
<b>C</b>	0.08	0.12
<b>Si</b>	0.32	0.10~0.60
<b>Mn</b>	1.54	1.20~1.90
<b>P</b>	0.005	0.020
<b>S</b>	0.007	0.020
<b>Ni</b>	0.45	0.20~1.00
<b>Cr</b>	8.79	8.00~10.50
<b>Mo</b>	0.86	0.80~1.20
<b>Cu</b>	0.09	0.35
<b>Nb</b>	0.02	0.01~0.10
<b>V</b>	0.17	0.15~0.50
<b>N</b>	0.02	0.01~0.05

Note: <sup>a</sup> Single values are maximum.**Welding parameters (A)**

φ mm	1F, 1G, 2F	2G, 3G uphill, 4G
1.2	260~320	140~200

**All-weld mechanical properties**

	Typical	Guaranty
<b>0.2%YS (MPa)</b>	570	414min.
<b>TS (MPa)</b>	700	621min.
<b>El on 4d (%)</b>	27	15min.
<b>IV 0°C (J)</b>	100	-
<b>PWHT (°C×h)</b>	740x8	745±15x1
<b>SG</b>	Ar-5%CO <sub>2</sub>	Ar-5%CO <sub>2</sub>

**Approvals**

<b>ABS</b>	MG (AWS A5.28 ER90S-G)
<b>LR</b>	MG
<b>NK</b>	MG

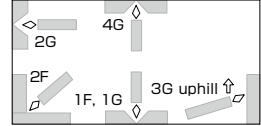
**Solid wire for 9-12%Cr-W-V-Nb steel****Features:** - Applied for ASTM A335 Gr. P92 and equivalents**Classification:** AWS A5.28 ER90S-G**Shielding gas:** Ar-2~5%O<sub>2</sub>, Ar-5~20%CO<sub>2</sub>**Polarity:** DCEP**Welding Positions:****Packaging data**

φ mm	Spool	
1.2	10kg	20kg
<b>Volume mm</b>	240W, 110H, 230L	280W, 110H, 270L

**Composition (wire mass%)**

	Typical	Guaranty <sup>a</sup>
<b>C</b>	0.04	0.12
<b>Si</b>	0.40	0.10~0.70
<b>Mn</b>	1.19	0.80~1.50
<b>P</b>	0.004	0.020
<b>S</b>	0.006	0.020
<b>Ni</b>	0.52	0.30~1.00
<b>Cr</b>	10.10	9.50~11.50
<b>Mo</b>	0.40	0.25~0.50
<b>Cu</b>	0.01	0.40
<b>Nb</b>	0.04	0.01~0.08
<b>V</b>	0.30	0.10~0.50
<b>W</b>	1.59	1.00~2.00
<b>N</b>	0.04	0.02~0.07
<b>Co</b>	1.59	1.00~1.70

Note: <sup>a</sup>Single values are maximum.**Welding parameters (A)**

φ mm	1F, 1G, 2F	2G, 3G uphill, 4G
1.2	260~320	140~200

**All-weld mechanical properties**

	Typical	Guaranty
<b>0.2%YS (MPa)</b>	590	531min.
<b>TS (MPa)</b>	720	621min.
<b>El on 4d (%)</b>	25	15min.
<b>IV 20°C (J)</b>	70	-
<b>PWHT (°C×h)</b>	750x8	750±15x1
<b>SG</b>	Ar-5%CO <sub>2</sub>	Ar-5%CO <sub>2</sub>

**TIG wire and rod for Mn-Mo and Mn-Mo-Ni steel**

<b>Features:</b>	• Applied for ASTM A533 Type A, B, C, D and equivalents
<b>Classification:</b>	AWS A5.28 ER80S-G
<b>Shielding Gas:</b>	Ar
<b>Identification color:</b>	1st Silver grey
<b>Polarity:</b>	DCEN

**Packaging data**

φ mm	kg	Tube	
		Length mm	g/piece
1.2	5	1,000	9
1.6	5	1,000	16
2.0	5	1,000	25
2.4	5	1,000	35
<b>Volume mm</b>	40W, 35H, 1015L		

**Composition (wire mass%)**

	Typical	Guaranty <sup>a</sup>
<b>C</b>	0.10	0.12
<b>Si</b>	0.39	0.20~0.60
<b>Mn</b>	1.52	1.20~1.80
<b>P</b>	0.003	0.025
<b>S</b>	0.007	0.025
<b>Ni</b>	0.62	0.40~0.80
<b>Mo</b>	0.49	0.40~0.60
<b>Cu</b>	0.16	0.35

Note: <sup>a</sup>Single values are maximum.**All-weld mechanical properties**

	Typical	Guaranty
<b>0.2%YS (MPa)</b>	520	469min.
<b>TS (MPa)</b>	590	552min.
<b>EI on 4d (%)</b>	31	19min.
<b>IV -12°C (J)</b>	290	-
<b>PWHT (°C×h)</b>	620x1	620±15x1

**TIG wire and rod for Mn-Mo and Mn-Mo-Ni steel**

<b>Features:</b>	• Applied for ASTM A533 Type A, B, C, D and equivalents
<b>Classification:</b>	AWS A5.28 ER90S-G
<b>Shielding Gas:</b>	Ar
<b>Identification color:</b>	1st Light green
<b>Polarity:</b>	DCEN

**Packaging data**

ø mm	Tube		
	kg	Length mm	g/piece
1.6	5	1,000	16
2.0	5	1,000	25
2.4	5	1,000	35
3.2	5	1,000	63
<b>Volume mm</b>	40W, 35H, 1015L		

**Composition (wire mass%)**

	Typical	Guaranty <sup>a</sup>
<b>C</b>	0.12	0.15
<b>Si</b>	0.34	0.20~0.50
<b>Mn</b>	1.27	1.05~1.45
<b>P</b>	0.003	0.025
<b>S</b>	0.007	0.025
<b>Ni</b>	1.58	1.45~1.75
<b>Cr</b>	0.02	0.30
<b>Mo</b>	0.41	0.25~0.55
<b>Cu</b>	0.11	0.35
<b>V</b>	<0.01	0.05

Note: <sup>a</sup> Single values are maximum.**All-weld mechanical properties**

	Typical	Guaranty
<b>0.2%YS (MPa)</b>	570	530min.
<b>TS (MPa)</b>	660	621min.
<b>EI on 4d (%)</b>	27	15min.
<b>IV -12°C (J)</b>	260	-
<b>PWHT (°C/h)</b>	625x15	620x1

**TIG wire and rod for 0.5%Mo steel**

<b>Features:</b>	• Applied for ASTM A204 Gr. A, B, C and equivalents
<b>Classification:</b>	AWS A5.28 ER70S-A1
<b>Shielding Gas:</b>	Ar
<b>Identification color:</b>	1st Green
<b>Polarity:</b>	DCEN

**Packaging data**

ϕ mm	Tube		
	kg	Length mm	g/piece
1.6	5	1,000	16
2.0	5	1,000	25
2.4	5	1,000	35
3.2	5	1,000	63
<b>Volume mm</b>	40W, 35H, 1015L		

**Composition (wire mass%)**

	Typical	Guaranty <sup>a</sup>
<b>C</b>	0.06	0.12
<b>Si</b>	0.53	0.30~0.70
<b>Mn</b>	1.03	1.30
<b>P</b>	0.006	0.025
<b>S</b>	0.008	0.025
<b>Ni</b>	0.02	0.20
<b>Mo</b>	0.54	0.40~0.65
<b>Cu</b>	0.15	0.35

Note: <sup>a</sup>Single values are maximum.

**All-weld mechanical properties**

	Typical	Guaranty
<b>0.2%YS (MPa)</b>	530	400min.
<b>TS (MPa)</b>	610	518min.
<b>EI on 4d (%)</b>	32	19min.
<b>IV 0°C (J)</b>	270	-
<b>PWHT (°C×h)</b>	620x1	620±15x1

## TIG wire and rod for 0.5%Mo steel

<b>Features:</b>	• Applied for ASTM A204 Gr. A, B, C and equivalents
<b>Classification:</b>	AWS A5.28 ER80S-G
<b>Shielding Gas:</b>	Ar
<b>Identification color:</b>	1st Green
<b>Polarity:</b>	DCEN

## Packaging data

ø mm	Spool		Tube	
	kg	kg	Length mm	g/piece
1.0	10	-	-	-
1.2	10	5	1,000	9
1.6	10	5	1,000	16
2.0	-	5	1,000	25
2.4	-	5	1,000	35
3.2	-	5	1,000	63
<b>Volume mm</b>	240W, 110H, 230L		40W, 35H, 1015L	

## Composition (wire mass%)

	Typical	Guaranty <sup>a</sup>
<b>C</b>	0.06	0.05~0.12
<b>Si</b>	0.53	0.30~0.70
<b>Mn</b>	1.03	1.30
<b>P</b>	0.006	0.025
<b>S</b>	0.008	0.025
<b>Ni</b>	0.02	0.20
<b>Mo</b>	0.54	0.40~0.65
<b>Cu</b>	0.15	0.35

Note: <sup>a</sup> Single values are maximum.

## All-weld mechanical properties

	Typical	Guaranty
<b>0.2%YS (MPa)</b>	500	469min.
<b>TS (MPa)</b>	580	552min.
<b>El on 4d (%)</b>	32	19min.
<b>IV 0°C (J)</b>	280	-
<b>PWHT (°C×h)</b>	620x1	AW

## Approvals

<b>ABS</b>	MG
------------	----

**TIG wire and rod for 1.25%Cr-0.5%Mo steel**

<b>Features:</b>	• Applied for ASTM A213 Gr.11 and equivalents
<b>Classification:</b>	AWS A5.28 ER80S-B2
<b>Shielding Gas:</b>	Ar
<b>Identification color:</b>	1st Silver
<b>Polarity:</b>	DCEN

**Packaging data**

φ mm	Spool	Tube		
	kg	kg	Length mm	g/piece
1.0	10	-	-	-
1.2	10	5	1,000	9
1.6	-	5	1,000	16
2.0	-	5	1,000	25
2.4	-	5	1,000	35
3.2	-	5	1,000	63
<b>Volume mm</b>	240W, 110H, 230L	40W, 35H, 1015L		

**Composition (wire mass%)**

	Typical	Guaranty <sup>a</sup>
<b>C</b>	0.10	0.07~0.12
<b>Si</b>	0.52	0.40~0.70
<b>Mn</b>	0.60	0.40~0.70
<b>P</b>	0.004	0.025
<b>S</b>	0.007	0.025
<b>Ni</b>	0.03	0.20
<b>Cr</b>	1.35	1.20~1.50
<b>Mo</b>	0.52	0.40~0.65
<b>Cu</b>	0.15	0.35

Note: <sup>a</sup> Single values are maximum.

**All-weld mechanical properties**

	Typical	Guaranty
<b>0.2%YS (MPa)</b>	490	469min.
<b>TS (MPa)</b>	630	552min.
<b>EI on 4d (%)</b>	32	19min.
<b>IV -20°C (J)</b>	250	-
<b>PWHT (°C×h)</b>	620x1	620±15x1

**TIG wire and rod for 1.25%Cr-0.5%Mo steel**

**Features:** • Applied for ASTM A387 Gr.11, Gr.12 and equivalents  
**Classification:** AWS A5.28 ER80S-B2Mn  
**Shielding Gas:** Ar  
**Identification color:** 1st Silver  
**Polarity:** DCEN

**Packaging data**

φ mm	Spool			Coil	Tube		
	kg			kg	kg	Length mm	g/piece
0.8	1	5	10	-	-	-	-
1.0	-	5	10	-	-	-	-
1.2	-	-	10	-	5	1,000	9
1.6	-	-	10	-	5	1,000	16
2.0	-	-	-	-	5	1,000	25
2.4	-	-	-	-	5	1,000	35
3.2	-	-	-	25	5	1,000	63
<b>Volume mm</b>	280W, 110H, 280L/10pcs	240W, 110H, 230L	430W, 90H, 430L	40W, 35H, 1015L			

**Composition (wire mass%)**

	Typical	Guaranty <sup>a</sup>
<b>C</b>	0.08	0.05~0.12
<b>Si</b>	0.52	0.30~0.70
<b>Mn</b>	1.06	0.80~1.20
<b>P</b>	0.006	0.025
<b>S</b>	0.007	0.025
<b>Ni</b>	0.02	0.20
<b>Cr</b>	1.40	1.00~1.50
<b>Mo</b>	0.55	0.40~0.65
<b>Cu</b>	0.20	0.35

Note: <sup>a</sup>Single values are maximum.

**All-weld mechanical properties**

	Typical	Guaranty
<b>0.2%YS (MPa)</b>	630	469min.
<b>TS (MPa)</b>	740	552min.
<b>El on 4d (%)</b>	28	19min.
<b>IV -20°C (J)</b>	210	-
<b>PWHT (°Cx h)</b>	620x1	620±15x1

**Approvals**

<b>ABS</b>	MG (AWS A5.28 ER80S-G)
<b>LR</b>	MG
<b>DNV</b>	VL1Cr0.5Mo, MG
<b>BV</b>	UP (AWS A5.28 ER80S-G)
<b>NK</b>	MG (AWS A5.28 ER80S-G)
<b>KR</b>	MG (AWS A5.28 ER80S-G)



## TIG wire and rod for 1.25%Cr-0.5%Mo steel

**Features:**

- Applied for ASTM A387 Gr.11, Gr.12 and equivalents
- Lower carbon content than TG-S1CM

**Classification:** AWS A5.28 ER80S-G

**Shielding Gas:** Ar

**Identification color:** 1st Blue

**Polarity:** DCEN

## Packaging data

φ mm	Spool		Tube		
	kg		kg	Length mm	g/piece
0.8	10	-	-	-	-
1.0	10	20	-	-	-
1.2	10	20	-	-	-
1.6	-	-	5	1,000	16
2.0	-	-	5	1,000	25
2.4	-	-	5	1,000	35
3.2	-	-	5	1,000	63
<b>Volume mm</b>	240W, 110H, 230L	280W, 110H, 270L	40W, 35H, 1015L		

## Composition (wire mass%)

	Typical	Guaranty <sup>a</sup>
<b>C</b>	0.03	0.05
<b>Si</b>	0.47	0.20~0.70
<b>Mn</b>	1.07	0.80~1.30
<b>P</b>	0.004	0.025
<b>S</b>	0.010	0.025
<b>Ni</b>	0.02	0.20
<b>Cr</b>	1.40	1.00~1.50
<b>Mo</b>	0.51	0.40~0.65
<b>Cu</b>	0.12	0.35

## All-weld mechanical properties

	Typical	Guaranty
<b>0.2%YS (MPa)</b>	480	469min.
<b>TS (MPa)</b>	580	552min.
<b>El on 4d (%)</b>	31	19min.
<b>IV 0°C (J)</b>	300	-
<b>PWHT (°Cx h)</b>	620x1	AW

Note: <sup>a</sup> Single values are maximum.

**TIG wire and rod for 2.25%Cr-1%Mo steel**

<b>Features:</b>	• Applied for ASTM A387 Gr.22 and equivalents
<b>Classification:</b>	AWS A5.28 ER90S-B3
<b>Shielding Gas:</b>	Ar
<b>Identification color:</b>	1st Brown
<b>Polarity:</b>	DCEN

**Packaging data**

Ø mm	Spool		Tube	
	kg	kg	Length mm	g/piece
1.0	10	-	-	-
1.2	10	-	-	-
1.6	-	5	1,000	16
2.0	-	5	1,000	25
2.4	-	5	1,000	35
3.2	-	5	1,000	63
<b>Volume mm</b>	240W, 110H, 230L		40W, 35H, 1015L	

**Composition (wire mass%)**

	Typical	Guaranty <sup>a</sup>
<b>C</b>	0.09	0.07~0.12
<b>Si</b>	0.64	0.40~0.70
<b>Mn</b>	0.60	0.40~0.70
<b>P</b>	0.004	0.025
<b>S</b>	0.006	0.025
<b>Cr</b>	2.39	2.30~2.70
<b>Mo</b>	1.08	0.90~1.20
<b>Ni</b>	0.06	0.20
<b>Cu</b>	0.15	0.35

**All-weld mechanical properties**

	Typical	Guaranty
<b>0.2%YS (MPa)</b>	600	538min.
<b>TS (MPa)</b>	730	621min.
<b>EI on 4d (%)</b>	27	17min.
<b>IV -20°C (J)</b>	240	-
<b>PWHT (°C×h)</b>	690x1	690±15x1

Note: <sup>a</sup>Single values are maximum.

**TIG wire and rod for 2.25%Cr-1%Mo steel**

**Features:** • Applied for ASTM A387 Gr.22 and equivalents  
**Classification:** AWS A5.28 ER90S-B3Mn  
**Shielding Gas:** Ar  
**Identification color:** 1st Brown  
**Polarity:** DCEN

**Packaging data**

φ mm	Spool				Tube		
	kg				kg	Length mm	g/piece
0.8	1	5	10	-	-	-	-
1.0	-	-	10	-	-	-	-
1.2	-	-	10	20	5	1,000	9
1.6	-	-	10	-	5	1,000	16
2.0	-	-	-	-	5	1,000	25
2.4	-	-	-	-	5	1,000	35
3.2	-	-	-	-	5	1,000	63
<b>Volume mm</b>	280W, 110H, 280L/10pcs	240W, 110H, 230L	280W, 110H, 270L		40W, 35H, 1015L		

**Composition (wire mass%)**

	Typical	Guaranty <sup>a</sup>
<b>C</b>	0.11	0.05~0.15
<b>Si</b>	0.36	0.60
<b>Mn</b>	0.70	0.50~1.20
<b>P</b>	0.005	0.025
<b>S</b>	0.008	0.025
<b>Ni</b>	0.04	0.20
<b>Cr</b>	2.29	2.10~2.50
<b>Mo</b>	1.07	0.90~1.20
<b>Cu</b>	0.15	0.35

Note: <sup>a</sup>Single values are maximum.

**All-weld mechanical properties**

	Typical	Guaranty
<b>0.2%YS (MPa)</b>	610	538min.
<b>TS (MPa)</b>	720	621min.
<b>El on 4d (%)</b>	28	17min.
<b>IV 0°C (J)</b>	250	-
<b>PWHT (°C×h)</b>	690x1	690±15x1

**Approvals**

<b>ABS</b>	MG
<b>LR</b>	MG
<b>DNV</b>	VL2.25Cr1Mo, MG
<b>BV</b>	UP(AWS A5.28 ER90S-G)
<b>NK</b>	MG
<b>KR</b>	MG(AWS A5.28 ER90S-G)

**TIG wire and rod for 2.25%Cr-1%Mo steel**

**Features:**

- Applied for ASTM A387 Gr.22 and equivalents
- Lower carbon content than TG-S2CM

**Classification:** AWS A5.28 ER80S-G

**Shielding Gas:** Ar

**Identification color:** 1st Red

**Polarity:** DCEN

**Packaging data**

φ mm	Spool		Tube		
	kg		kg	Length mm	g/piece
1.0	10	20	-	-	-
1.2	10	20	5	1,000	-
1.6	10	-	5	1,000	16
2.0	-	-	5	1,000	25
2.4	-	-	5	1,000	35
<b>Volume mm</b>	240W, 110H, 230L	280W, 110H, 270L	40W, 35H, 1015L		

**Composition (wire mass%)**

	Typical	Guaranty <sup>a</sup>
<b>C</b>	0.04	0.05
<b>Si</b>	0.50	0.30~0.80
<b>Mn</b>	1.09	0.80~1.40
<b>P</b>	0.005	0.025
<b>S</b>	0.010	0.025
<b>Ni</b>	0.02	0.20
<b>Cr</b>	2.34	2.10~2.70
<b>Mo</b>	1.10	0.90~1.20
<b>Cu</b>	0.16	0.40

Note: <sup>a</sup> Single values are maximum.

**All-weld mechanical properties**

	Typical	Guaranty
<b>0.2%YS (MPa)</b>	520	469min.
<b>TS (MPa)</b>	630	552min.
<b>El on 4d (%)</b>	28	19min.
<b>IV 0°C (J)</b>	250	-
<b>PWHT (°C×h)</b>	690x1	690±15x1

**TIG wire and rod for 2.25%Cr-1%Mo-V steel**

**Features:**

- Applied for ASTM A542 Type D Cl.4a and equivalents
- Excellent tensile strength at high temperatures and less sensitive to temper embrittlement

**Classification:** AWS A5.28 ER90S-G

**Shielding Gas:** Ar

**Identification color:** 1st Silver

**Polarity:** DCEN

**Packaging data**

ϕ mm	Spool		Tube		
	kg		kg	Length mm	g/piece
1.0	10	-	-	-	-
1.2	10	20	5	1,000	9
1.6	-	-	5	1,000	16
2.0	-	-	5	1,000	25
2.4	-	-	5	1,000	35
<b>Volume mm</b>	240W, 110H, 230L	280W, 110H, 270L	40W, 35H, 1015L		

**Composition (wire mass%)**

	Typical	Guaranty <sup>a</sup>
<b>C</b>	0.12	0.05~0.15
<b>Si</b>	0.16	0.50
<b>Mn</b>	0.41	0.20~1.10
<b>P</b>	0.004	0.010
<b>S</b>	0.007	0.010
<b>Ni</b>	0.02	0.20
<b>Cr</b>	2.31	2.00~2.60
<b>Mo</b>	1.06	0.90~1.20
<b>V</b>	0.28	0.20~0.40
<b>Nb</b>	0.033	0.010~0.040
<b>Cu</b>	0.14	0.35

Note: <sup>a</sup> Single values are maximum.

**All-weld Mechanical properties**

	Typical	Guaranty
<b>0.2%YS (MPa)</b>	620	-
<b>TS (MPa)</b>	730	621min.
<b>El on 4d (%)</b>	22	-
<b>IV -18°C (J)</b>	300	-
<b>PWHT (°C×h)</b>	705×7	705±15×8

**TIG wire and rod for low C-2.25%Cr-W-V-Nb steel**

**Features:**                   ▪ Applied for ASTM A335 Gr. P23 and equivalents  
**Classification:**        AWS A5.28 ER80S-G  
**Shielding Gas:**         Ar  
**Identification color:** 1st Blue white  
**Polarity:**                 DCEN

**Packaging data**

ø mm	Spool		Tube	
	kg	kg	Length mm	g/piece
0.8	10	-	-	-
1.0	10	-	-	-
1.2	10	-	-	-
2.0	-	5	1,000	25
2.4	-	5	1,000	35
<b>Volume mm</b>	240W, 110H, 230L		40W, 35H, 1015L	

**Composition (wire mass%)**

	Typical	Guaranty <sup>a</sup>
<b>C</b>	0.05	0.12
<b>Si</b>	0.42	0.10~0.60
<b>Mn</b>	0.46	0.20~1.00
<b>P</b>	0.006	0.020
<b>S</b>	0.008	0.010
<b>Cr</b>	2.30	2.00~2.60
<b>Mo</b>	0.47	0.40~0.65
<b>Cu</b>	0.17	0.40
<b>Nb</b>	0.03	0.01~0.08
<b>V</b>	0.32	0.15~0.40
<b>W</b>	1.19	1.00~2.00
<b>Al</b>	<0.01	0.03

Note: <sup>a</sup>Single values are maximum.

**All-weld mechanical properties**

	Typical	Guaranty
<b>0.2%YS (MPa)</b>	470	400min.
<b>TS (MPa)</b>	580	520min.
<b>EI on 4d (%)</b>	31	17min.
<b>IV 0°C (J)</b>	210	-
<b>PWHT (°C×h)</b>	715x2	715±15x2

**Approvals**

<b>ABS</b>	MG
<b>LR</b>	MG
<b>NK</b>	MG

**TIG wire and rod for 9%Cr-1%Mo-V-Nb steel**

**Features:**

- Applied for ASTM A387 Gr.91 and equivalents
- Excellent creep rupture strength

**Classification:** AWS A5.28 ER90S-B91

**Shielding Gas:** Ar

**Identification color:** 1st Purple Blue

**Polarity:** DCEN

**Packaging data**

φ mm	Spool		Tube	
	kg	kg	Length mm	g/piece
1.0	10	-	-	-
1.2	10	-	-	-
1.6	10	5	1,000	16
2.0	-	5	1,000	25
2.4	-	5	1,000	35
3.2	-	5	1,000	63
<b>Volume mm</b>	240W, 110H, 230L		40W, 35H, 1015L	

**Composition (wire mass%)**

	Typical	Guaranty <sup>a</sup>
<b>C</b>	0.10	0.07~0.13
<b>Si</b>	0.29	0.15~0.50
<b>Mn</b>	0.72	1.20
<b>P</b>	0.004	0.010
<b>S</b>	0.005	0.010
<b>Cu</b>	0.01	0.20
<b>Cr</b>	8.36	8.00~10.50
<b>Mo</b>	0.97	0.85~1.20
<b>Ni</b>	0.15	0.80
<b>Co</b>	0.41	-
<b>V</b>	0.18	0.15~0.30
<b>Al</b>	<0.01	0.04
<b>Nb</b>	0.06	0.02~0.10
<b>N</b>	0.04	0.03~0.07
<b>Mn+Ni</b>	0.87	1.50

Note: <sup>a</sup> Single values are maximum.

**All-weld mechanical properties**

	Typical	Guaranty
<b>0.2%YS (MPa)</b>	620	414min.
<b>TS (MPa)</b>	750	621min.
<b>El on 4d (%)</b>	25	16min.
<b>IV 0°C (J)</b>	150	-
<b>PWHT (°C×h)</b>	760x2	760±15x2

**TIG wire and rod for 9%Cr-1%Mo-V-Nb steel**

**Features:**

- Applied for ASTM A387 Gr.91 and equivalents
- Excellent creep rupture strength

**Classification:** AWS A5.28 ER90S-B91C

**Shielding Gas:** Ar

**Identification color:** 1st Grey

**Polarity:** DCEN

**Packaging data**

φ mm	Spool		Tube		
	kg		kg	Length mm	g/piece
0.8	5	10	-	-	-
1.0	-	10	-	-	-
1.2	-	10	-	-	-
1.6	-	10	5	1,000	16
2.0	-	-	5	1,000	25
2.4	-	-	5	1,000	35
3.2	-	-	5	1,000	63
<b>Volume mm</b>	240W, 110H, 230L		40W, 35H, 1015L		

**Composition (wire mass%)**

	Typical	Guaranty <sup>a</sup>
<b>C</b>	0.07	0.12
<b>Si</b>	0.16	0.50
<b>Mn</b>	1.00	0.50~1.20
<b>P</b>	0.006	0.020
<b>S</b>	0.004	0.010
<b>Ni</b>	0.67	0.10~0.80
<b>Cr</b>	8.98	8.00~10.00
<b>Mo</b>	0.88	0.85~1.20
<b>Nb</b>	0.04	0.02~0.12
<b>V</b>	0.18	0.10~0.35
<b>Cu</b>	0.03	0.35
<b>N</b>	0.02	0.01~0.05

Note: <sup>a</sup>Single values are maximum.

**All-weld mechanical properties**

	Typical	Guaranty
<b>0.2%YS (MPa)</b>	700	414min.
<b>TS (MPa)</b>	780	621min.
<b>EI on 4d (%)</b>	24	16min.
<b>IV 0°C (J)</b>	240	-
<b>PWHT (°C×h)</b>	740x8	745±15x1

**Approvals**

<b>ABS</b>	MG
<b>LR</b>	MG
<b>NK</b>	MG



**TIG wire and rod for 9-12%Cr-W-V-Nb steel**

**Features:**

- Applied for ASTM A335 Gr. P92 and equivalents
- Excellent creep rupture strength

**Classification:** AWS A5.28 ER90S-G

**Shielding Gas:** Ar

**Polarity:** DCEN

**Packaging data**

ϕ mm	Spool	Tube		
	kg	kg	Length mm	g/piece
1.0	10	-	-	-
2.0	-	5	1,000	25
2.4	-	5	1,000	35
<b>Volume mm</b>	240W, 110H, 230L		40W, 35H, 1015L	

**Composition (wire mass%)**

	Typical	Guaranty <sup>a</sup>
<b>C</b>	0.07	0.12
<b>Si</b>	0.36	0.10~0.50
<b>Mn</b>	0.74	0.20~1.00
<b>P</b>	0.004	0.020
<b>S</b>	0.003	0.010
<b>Ni</b>	0.51	0.30~0.80
<b>Cr</b>	9.92	9.50~11.50
<b>Mo</b>	0.35	0.20~0.55
<b>Cu</b>	0.01	0.40
<b>Nb</b>	0.04	0.01~0.08
<b>V</b>	0.21	0.10~0.35
<b>W</b>	1.45	1.00~2.00
<b>Co</b>	1.01	0.80~1.20
<b>N</b>	0.04	0.02~0.07

Note: <sup>a</sup> Single values are maximum.

**All-weld mechanical properties**

	Typical	Guaranty
<b>0.2%YS (MPa)</b>	670	531min.
<b>TS (MPa)</b>	790	621min.
<b>El on 4d (%)</b>	23	17min.
<b>IV 0°C (J)</b>	40	-
<b>PWHT (°C×h)</b>	740x8	750±15

## Flux and wire combination for Mn-Mo and Mn-Mo-Ni steel

**Features:** - Applied for ASTM A533 Type A, B, C, D and equivalents

**Classification:** AWS A5.23 F9P4-EG-G

**Type of flux:** Bonded

**Redrying of flux:** 200~300°C×1h

**Polarity:** AC

## Packaging data

Flux	Mesh	Can	
PF-200	48xD	20kg	
Volume mm		240W, 350H, 240L	
Wire	φ mm	Coil	
US-56B	3.2	25kg	-
	4.0	25kg	75kg
	4.8	25kg	75kg
Volume mm		430W, 90H, 430L	740W, 110H, 740L

## Composition (wire mass%)

	Typical	Guaranty <sup>a</sup>
<b>C</b>	0.11	0.15
<b>Si</b>	0.17	0.35
<b>Mn</b>	1.59	1.40~2.20
<b>P</b>	0.003	0.018
<b>S</b>	0.001	0.018
<b>Ni</b>	0.86	0.70~1.20
<b>Cr</b>	0.03	0.20
<b>Mo</b>	0.48	0.40~0.70
<b>Cu</b>	0.06	0.30

## Composition (weld metal mass%)

	Typical	Guaranty <sup>a</sup>
<b>C</b>	0.08	0.12
<b>Si</b>	0.11	0.50
<b>Mn</b>	1.33	0.90~1.80
<b>P</b>	0.007	0.020
<b>S</b>	0.003	0.020
<b>Ni</b>	0.83	0.70~1.20
<b>Mo</b>	0.43	0.40~0.70
<b>Cu</b>	0.08	0.30

Note: <sup>a</sup> Single values are maximum.

Note: <sup>a</sup> Single values are maximum.

## Weld mechanical properties

	Typical	Guaranty
<b>0.2%YS (MPa)</b>	580	538min.
<b>TS (MPa)</b>	660	621~758
<b>EI on 4d (%)</b>	31	17min.
<b>IV -40°C (J)</b>	160	27min.
<b>PWHT (°Cxh)</b>	620x1	620±15x1

**PF-200/US-63S****Flux and wire combination for Mn-Mo and Mn-Mo-Ni steel**

**Features:** ▪ Applied for ASTM A533 Type A, B, C, D Class 2 and equivalents

**Classification:** AWS A5.23 F10P2-EG-G

**Type of flux:** Bonded

**Redrying of flux:** 200~300°Cx1h

**Polarity:** AC

**Packaging data**

Flux	Mesh	Can	
PF-200	48xD	20kg	
Volume mm		240W, 350H, 240L	
Wire	φ mm	Coil	
US-63S	3.2	25kg	-
	4.0	25kg	75kg
	4.8	25kg	75kg
Volume mm		430W, 90H, 430L	740W, 110H, 740L

**Composition (wire mass%)**

	Typical	Guaranty <sup>a</sup>
<b>C</b>	0.11	0.15
<b>Si</b>	0.14	0.40
<b>Mn</b>	1.70	1.30~2.20
<b>P</b>	0.006	0.020
<b>S</b>	0.004	0.020
<b>Ni</b>	1.47	1.00~1.75
<b>Cr</b>	0.16	0.40
<b>Mo</b>	0.47	0.30~0.80
<b>Cu</b>	0.08	0.30

Note: <sup>a</sup> Single values are maximum.

**Composition (weld metal mass%)**

	Typical	Guaranty <sup>a</sup>
<b>C</b>	0.08	0.16
<b>Si</b>	0.10	0.60
<b>Mn</b>	1.51	1.00~2.00
<b>P</b>	0.007	0.020
<b>S</b>	0.004	0.020
<b>Ni</b>	1.31	1.00~1.75
<b>Mo</b>	0.47	0.30~0.80
<b>Cr</b>	0.14	0.40

Note: <sup>a</sup> Single values are maximum.

**Weld mechanical properties**

	Typical	Guaranty
<b>0.2%YS (MPa)</b>	630	607min.
<b>TS (MPa)</b>	710	689~827
<b>El on 4d (%)</b>	24	16min.
<b>IV (J)</b>	-20°C:120	-29°C:27min.
<b>PWHT (°Cxh)</b>	610x2	620±15x1

# FAMILIARC™ MF-38/ TRUSTARC™ US-A4

## Flux and wire combination for 0.5%Mo steel

**Features:** • Applied for ASTM A204 Gr. A, B, C and equivalents

**Classification:** AWS A5.23 F8P6-EA4-A4, F8A4-EA4-A4

**Type of flux:** Fused

**Redrying of flux:** 150~350°Cx1h

**Polarity:** AC

### Packaging data

Flux	Mesh	Can	Wire	φ mm	Coil
MF-38	12x65	25kg	US-A4	3.2	25kg
	20x200	25kg		4.0	25kg
	20xD	25kg		4.8	25kg
Volume mm		240W, 350H, 240L	Volume mm		430W, 90H, 430L

### Composition (wire mass%)

	Typical	Guaranty <sup>a</sup>
<b>C</b>	0.09	0.05~0.15
<b>Si</b>	0.04	0.20
<b>Mn</b>	1.59	1.20~1.70
<b>P</b>	0.01	0.025
<b>S</b>	0.014	0.025
<b>Ni</b>	0.02	0.25
<b>Cr</b>	0.04	0.15
<b>Mo</b>	0.52	0.45~0.65
<b>Cu</b>	0.10	0.35

Note: <sup>a</sup> Single values are maximum.

### Composition (weld metal mass%)

	Typical	Guaranty <sup>a</sup>
<b>C</b>	0.10	0.15
<b>Si</b>	0.39	0.80
<b>Mn</b>	1.35	1.60
<b>P</b>	0.013	0.030
<b>S</b>	0.013	0.030
<b>Mo</b>	0.52	0.40~0.65
<b>Cu</b>	0.11	0.35

Note: <sup>a</sup> Single values are maximum.

### Weld mechanical properties

	Typical	Guaranty
<b>0.2%YS (MPa)</b>	510	469min.
<b>TS (MPa)</b>	600	552~689
<b>EI on 4d (%)</b>	29	20min.
<b>IV -51°C (J)</b>	40	27min.
<b>PWHT (°Cxh)</b>	620x1	620±15x1

# FAMILIARC™ MF-38/ TRUSTARC™ US-49

## Flux and wire combination for 0.5%Mo steel

**Features:** ▪ Applied for ASTM A204 Gr. A, B, C and equivalents

**Classification:** AWS A5.23 F8P6-EG-A4, F8A4-EG-A4

**Type of flux:** Fused

**Redrying of flux:** 150~350°Cx1h

**Polarity:** AC

### Packaging data

Flux		Can				
MF-38	12x65	25kg				
	20x200	25kg				
	20xD	25kg				
<b>Volume mm</b>		240W, 350H, 240L				
Wire	φ mm	Spool		Coil		
US-49	1.6	-	20kg	-	-	-
	2.0	10kg	-	-	-	-
	2.4	10kg	-	25kg	-	-
	3.2	-	-	25kg	76kg	-
	4.0	-	-	25kg	75kg	-
	4.8	-	-	25kg	75kg	150kg
	6.4	-	-	25kg	-	159kg
<b>Volume mm</b>		240W, 110H, 230L	280W, 110H, 270L	430W, 90H, 430L	740W, 110H, 740L	840W, 110H, 840L

### Composition (wire mass%)

	Typical	Guaranty <sup>a</sup>
<b>C</b>	0.10	0.07~0.12
<b>Si</b>	0.02	0.05
<b>Mn</b>	1.58	1.25~1.80
<b>P</b>	0.009	0.025
<b>S</b>	0.011	0.025
<b>Mo</b>	0.53	0.45~0.60
<b>Cu</b>	0.11	0.35

Note: <sup>a</sup> Single values are maximum.

### Composition (weld metal mass%)

	Typical	Guaranty <sup>a</sup>
<b>C</b>	0.10	0.15
<b>Si</b>	0.37	0.80
<b>Mn</b>	1.35	1.60
<b>P</b>	0.014	0.030
<b>S</b>	0.014	0.030
<b>Mo</b>	0.53	0.40~0.65
<b>Cu</b>	0.09	0.35

Note: <sup>a</sup> Single values are maximum.

### Weld mechanical properties

	Typical	Guaranty
<b>0.2%YS (MPa)</b>	510	469min.
<b>TS (MPa)</b>	590	552~689
<b>EI on 4d (%)</b>	30	20min.
<b>IV -51°C (J)</b>	50	27min.
<b>PWHT (°Cxh)</b>	620x1	620±15x1

### Approvals

<b>ABS</b>	3YM
<b>LR</b>	3YM
<b>DNV</b>	IIIYM
<b>BV</b>	A3YM
<b>NK</b>	KAW3Y46M H10
<b>CCS</b>	3YM

Note: Single electrode

# FAMILIARC™ MF-38/ TRUSTARC™ US-40

## Flux and wire combination for 0.5%Mo steel

**Features:** • Applied for ASTM A204 Gr. A, B, C and equivalents

**Classification:** AWS A5.23 F8P6-EA3-A3, F9A6-EA3-A3

**Type of flux:** Fused

**Redrying of flux:** 150~350°Cx1h

**Polarity:** AC

### Packaging data

Flux		Can	
MF-38	12x65	25kg	
	20x200	25kg	
	20xD	25kg	
Volume mm		240W, 350H, 240L	
Wire	φ mm	Spool	Coil
US-40	2.4	20kg	25kg
	3.2	-	25kg
	4.0	-	25kg
	4.8	-	25kg
	6.4	-	25kg
Volume mm		300W, 110H, 300L	430W, 90H, 430L

### Composition (wire mass%)

	Typical	Guaranty <sup>a</sup>
<b>C</b>	0.14	0.05~0.17
<b>Si</b>	0.02	0.20
<b>Mn</b>	1.78	1.65~2.20
<b>P</b>	0.009	0.025
<b>S</b>	0.014	0.025
<b>Mo</b>	0.52	0.45~0.65
<b>Cu</b>	0.11	0.35

Note: <sup>a</sup>Single values are maximum.

### Composition (weld metal mass%)

	Typical	Guaranty <sup>a</sup>
<b>C</b>	0.08	0.15
<b>Si</b>	0.34	0.80
<b>Mn</b>	1.58	2.10
<b>P</b>	0.017	0.030
<b>S</b>	0.009	0.030
<b>Mo</b>	0.45	0.40~0.65
<b>Cu</b>	0.12	0.35

Note: <sup>a</sup>Single values are maximum.

### Weld mechanical properties

	Typical	Guaranty
<b>0.2%YS (MPa)</b>	560	469min.
<b>TS (MPa)</b>	630	552~689
<b>EI on 4d (%)</b>	29	20min.
<b>IV -51°C (J)</b>	58	27min.
<b>PWHT (°Cxh)</b>	620x1	620±15x1

### Approvals

NK	KAW3Y50M, H10
----	---------------

Note: Single electrode

**PF-200/US-511N****Flux and wire combination for 1-1.25%Cr-0.5%Mo steel**

**Features:**

- Applied for ASTM A387 Gr.11, Gr.12 and equivalents
- Excellent notch toughness

**Classification:** AWS A5.23 F8P2-EG-B2

**Type of flux:** Bonded

**Redrying of flux:** 200~300°Cx1h

**Polarity:** AC

**Packaging data**

Flux		Can	
PF-200	10x48	20kg	
Volume mm		240W, 350H, 240L	
Wire	φ mm	Coil	
US-511N	3.2	25kg	-
	4.0	25kg	75kg
Volume mm		430W, 90H, 430L	740W, 110H, 740L

**Composition (wire mass%)**

	Typical	Guaranty <sup>a</sup>
<b>C</b>	0.09	0.15
<b>Si</b>	0.30	0.40
<b>Mn</b>	0.90	0.50~1.00
<b>P</b>	0.004	0.015
<b>S</b>	0.002	0.015
<b>Ni</b>	0.17	0.25
<b>Cr</b>	1.48	1.25~1.80
<b>Mo</b>	0.52	0.40~0.65
<b>Cu</b>	0.11	0.25

Note: <sup>a</sup> Single values are maximum.

**Composition (weld metal mass %)**

	Typical	Guaranty <sup>a</sup>
<b>C</b>	0.08	0.05~0.15
<b>Si</b>	0.20	0.80
<b>Mn</b>	0.88	1.20
<b>P</b>	0.007	0.030
<b>S</b>	0.002	0.030
<b>Ni</b>	0.15	0.25
<b>Cr</b>	1.39	1.00~1.50
<b>Mo</b>	0.55	0.40~0.65
<b>Cu</b>	0.11	0.35

Note: <sup>a</sup> Single values are maximum.

**Weld mechanical properties**

	Typical	Guaranty
<b>0.2%YS (MPa)</b>	510	469min.
<b>TS (MPa)</b>	620	552~689
<b>EI on 4d (%)</b>	24	20min.
<b>IV (J)</b>	-20°C: 150	-29°C: 27min.
<b>PWHT (°Cxh)</b>	690x1	690±15x1

**Approvals**

<b>BV</b>	UP (AWS A.23 F8P2-EG-B2)
-----------	--------------------------

**PF-200D/US-511ND****TRUSTARC™****Flux and wire combination for 1-1.25%Cr-0.5%Mo steel****Features:** • Applied for ASTM A387 Gr.11, Gr.12 and equivalents**Classification:** AWS A5.23 F8P2-EG-B2**Type of flux:** Bonded**Redrying of flux:** 200~300°Cx1h**Polarity:** DCEP**Packaging data**

Flux	Mesh	Can	Wire	φ mm	Coil
PF-200D	10x48	20kg	US-511ND	2.4	25kg
				3.2	25kg
				4.0	25kg
Volume mm		240W, 350H, 240L	Volume mm		430W, 90H, 430L

**Composition (wire mass%)**

	Typical	Guaranty <sup>a</sup>
<b>C</b>	0.13	0.15
<b>Si</b>	0.11	0.40
<b>Mn</b>	0.88	0.50~1.00
<b>P</b>	0.005	0.015
<b>S</b>	0.001	0.015
<b>Ni</b>	0.15	0.25
<b>Cr</b>	1.49	1.25~1.80
<b>Mo</b>	0.56	0.40~0.65
<b>Cu</b>	0.12	0.25

Note: <sup>a</sup>Single values are maximum.**Composition (weld metal mass%)**

	Typical	Guaranty <sup>a</sup>
<b>C</b>	0.08	0.05~0.15
<b>Si</b>	0.21	0.80
<b>Mn</b>	0.82	1.20
<b>P</b>	0.007	0.030
<b>S</b>	0.003	0.030
<b>Ni</b>	0.15	0.25
<b>Cr</b>	1.39	1.00~1.50
<b>Mo</b>	0.56	0.40~0.65
<b>Cu</b>	0.09	0.35

Note: <sup>a</sup>Single values are maximum.**Weld Mechanical properties**

	Typical	Guaranty
<b>0.2%YS (MPa)</b>	490	469min.
<b>TS (MPa)</b>	610	552~689
<b>El on 4d (%)</b>	27	20min.
<b>IV (J)</b>	-20°C: 150	-29°C: 27min.
<b>PWHT (°Cxh)</b>	690x1	690±15x1



# FAMILIARC™ G-80/ TRUSTARC™ US-B2

## Flux and wire combination for 1-1.25%Cr-0.5%Mo steel

**Features:**

- Applied for ASTM A387 Gr.11, Gr.12 and equivalents
- Suitable for 1 pass fillet welding in the panel fin tube fabrication

**Classification:** AWS A5.23 F7PZ-EB2-B2

**Type of flux:** Fused

**Redrying of flux:** 150~350°Cx1h

**Polarity:** DCEP

### Packaging data

Flux	Mesh	Can					
G-80	12x65	25kg					
	12x200	25kg					
	20x200	25kg					
	32x200	25kg					
	20xD	25kg					
<b>Volume mm</b>		240W, 350H, 240L					
Wire	φ mm	Spool		Coil			Drum
US-B2	1.6	10kg	20kg	-	-	-	400kg
	2.0	10kg	-	25kg	-	-	-
	2.4	10kg	-	25kg	-	150kg	-
	3.2	-	-	25kg	75kg	150kg	-
	4.0	-	-	25kg	75kg	150kg	-
	4.8	-	-	25kg	75kg	150kg	-
<b>Volume mm</b>		240W, 110H, 230L	280W, 110H, 270L	430W, 90H, 430L	740W, 110H, 740L	840W, 110H, 840L	600φ, 770H

### Composition (wire mass%)

	Typical	Guaranty <sup>a</sup>
<b>C</b>	0.11	0.07~0.15
<b>Si</b>	0.13	0.05~0.30
<b>Mn</b>	0.57	0.45~1.00
<b>P</b>	0.007	0.025
<b>S</b>	0.006	0.025
<b>Cr</b>	1.49	1.00~1.75
<b>Mo</b>	0.53	0.45~0.65
<b>Cu</b>	0.11	0.35

Note: <sup>a</sup> Single values are maximum.

### Composition (weld metal mass%)

	Typical	Guaranty <sup>a</sup>
<b>C</b>	0.06	0.05~0.15
<b>Si</b>	0.45	0.80
<b>Mn</b>	0.83	1.20
<b>P</b>	0.009	0.030
<b>S</b>	0.005	0.030
<b>Cr</b>	1.29	1.00~1.50
<b>Mo</b>	0.54	0.40~0.65
<b>Cu</b>	0.12	0.35

Note: <sup>a</sup> Single values are maximum.

### All-weld mechanical properties

	Typical	Guaranty
<b>0.2%YS (MPa)</b>	430	400min.
<b>TS (MPa)</b>	550	483~655
<b>El on 4d (%)</b>	27	22min.
<b>IV 20°C (J)</b>	40	-
<b>PWHT (°Cxh)</b>	690x1	690±15x1

**PF-200D/US-B2R****TRUSTARC™****Flux and wire combination for 1~1.25%Cr-0.5%Mo steel**

- Features:**
- Applied for ASTM A387 Gr.11 and equivalents
  - Satisfied the impurity elements index (X-factor $\leq$ 15) for Oil reactors

**Classification:** AWS A5.23 F8P2-EB2R-B2R

**Type of flux:** Bonded

**Redrying of flux:** 200~300°Cx1h

**Polarity:** DCEP

**Packaging data**

Flux	Mesh	Can	Wire	$\phi$ mm	Coil	
PF-200D	10x48	20kg	US-B2R	2.4	25kg	-
				3.2	25kg	-
				4.0	25kg	75kg
Volume mm		240W, 350H, 240L	Volume mm		430W, 90H, 430L	740W, 110H, 740L

**Composition (wire mass%)**

	Typical	Guaranty <sup>a</sup>
<b>C</b>	0.14	0.07~0.15
<b>Si</b>	0.10	0.05~0.30
<b>Mn</b>	0.86	0.45~1.00
<b>P</b>	0.004	0.010
<b>S</b>	0.004	0.010
<b>Cr</b>	1.47	1.00~1.75
<b>Mo</b>	0.56	0.45~0.65
<b>Cu</b>	0.12	0.15
<b>As</b>	0.003	0.005
<b>Sn</b>	0.001	0.005
<b>Sb</b>	0.001	0.005

Note: <sup>a</sup>Single values are maximum.

**Composition (weld metal mass%)**

	Typical	Guaranty <sup>a</sup>
<b>C</b>	0.10	0.05~0.15
<b>Si</b>	0.21	0.80
<b>Mn</b>	0.86	1.20
<b>P</b>	0.007	0.010
<b>S</b>	0.002	0.010
<b>Cr</b>	1.44	1.00~1.50
<b>Mo</b>	0.55	0.40~0.65
<b>Cu</b>	0.10	0.15
<b>As</b>	0.003	0.005
<b>Sn</b>	<0.001	0.005
<b>Sb</b>	<0.001	0.005

Note: <sup>a</sup>Single values are maximum.

**All-weld mechanical properties**

	Typical	Guaranty
<b>0.2%YS (MPa)</b>	500	469min.
<b>TS (MPa)</b>	610	552~689
<b>El on 4d (%)</b>	27	20min.
<b>IV -29°C (J)</b>	140	27min.
<b>PWHT (°Cxh)</b>	698x1	690 $\pm$ 15x1

# PF-200/US-521S

**Flux and wire combination for 2.25%Cr-1%Mo steel**

**Features:**

- Applied for ASTM A387 Gr.22 and equivalents
- Excellent notch toughness

**Classification:** AWS A5.23 F9P2-EG-B3

**Type of flux:** Bonded

**Redrying of flux:** 200~300°Cx1h

**Polarity:** AC

**Packaging data**

Flux		Can		
PF-200	10x48	20kg		
Volume mm		240W, 350H, 240L		
Wire		Coil		
US-521S	3.2	25kg	-	150kg
	4.0	25kg	75kg	150kg
Volume mm		430W, 90H, 430L	740W, 110H, 740L	840W, 110H, 840L

**Composition (wire mass%)**

	Typical	Guaranty <sup>a</sup>
<b>C</b>	0.16	0.08~0.18
<b>Si</b>	0.13	0.25
<b>Mn</b>	0.93	0.80~1.20
<b>P</b>	0.003	0.012
<b>S</b>	0.002	0.012
<b>Ni</b>	0.14	0.25
<b>Cr</b>	2.45	2.20~2.70
<b>Mo</b>	1.00	0.90~1.20
<b>Cu</b>	0.12	0.30

Note: <sup>a</sup> Single values are maximum.

**Composition (weld metal mass%)**

	Typical	Guaranty <sup>a</sup>
<b>C</b>	0.12	0.05~0.15
<b>Si</b>	0.10	0.80
<b>Mn</b>	0.82	1.20
<b>P</b>	0.008	0.030
<b>S</b>	0.001	0.030
<b>Ni</b>	0.13	0.25
<b>Cr</b>	2.34	2.00~2.50
<b>Mo</b>	1.04	0.90~1.20
<b>Cu</b>	0.12	0.35

Note: <sup>a</sup> Single values are maximum.

**Weld mechanical properties**

	Typical	Guaranty
<b>0.2%YS (MPa)</b>	470	538min.
<b>TS (MPa)</b>	610	621~758
<b>El on 4d (%)</b>	27	17min.
<b>IV -29°C (J)</b>	150	27min.
<b>PWHT (°C×h)</b>	690x8	690±15x1

**Approvals**

<b>BV</b>	UP (AWS A.23 F9P2-EG-B3)
-----------	--------------------------

**PF-200D/US-521S****TRUSTARC™****Flux and wire combination for 2.25%Cr-1%Mo steel**

**Features:**

- Applied for ASTM A387 Gr.22 and equivalents
- Excellent notch toughness

**Classification:** AWS A5.23 F9P2-EG-B3

**Type of flux:** Bonded

**Redrying of flux:** 200~300°Cx1h

**Polarity:** DCEP

**Packaging data**

Flux		Can			
PF-200D	10x48	20kg			
Volume mm		240W, 350H, 240L			
Wire	φ mm	Coil			
US-521S	3.2	25kg	-	150kg	
	4.0	25kg	75kg	150kg	
Volume mm		430W, 90H, 430L	740W, 110H, 740L	840W, 110H, 840L	

**Composition (wire mass%)**

	Typical	Guaranty <sup>a</sup>
<b>C</b>	0.16	0.08~0.18
<b>Si</b>	0.13	0.25
<b>Mn</b>	0.93	0.80~1.20
<b>P</b>	0.003	0.012
<b>S</b>	0.002	0.012
<b>Ni</b>	0.14	0.25
<b>Cr</b>	2.45	2.20~2.70
<b>Mo</b>	1.00	0.90~1.20
<b>Cu</b>	0.12	0.30

Note: <sup>a</sup>Single values are maximum.

**Composition (weld metal mass%)**

	Typical	Guaranty <sup>a</sup>
<b>C</b>	0.09	0.05~0.15
<b>Si</b>	0.16	0.80
<b>Mn</b>	0.81	1.20
<b>P</b>	0.006	0.030
<b>S</b>	0.003	0.030
<b>Ni</b>	0.13	0.25
<b>Cr</b>	2.41	2.00~2.50
<b>Mo</b>	1.07	0.90~1.20
<b>Cu</b>	0.13	0.35

Note: <sup>a</sup>Single values are maximum.

**Weld mechanical properties**

	Typical	Guaranty
<b>0.2%YS (MPa)</b>	510	538min.
<b>TS (MPa)</b>	620	621~758
<b>El on 4d (%)</b>	26	17min.
<b>IV -29°C (J)</b>	160	27min.
<b>PWHT (°C×h)</b>	690x6	690±15x1

**PF-500/US-521H****Flux and wire combination for 2.25%Cr-1%Mo-V steel**

**Features:**

- Applied for ASTM A542 Type D Cl.4a and equivalents
- Excellent tensile strength at high temperatures and good creep rupture strength

**Classification:** AWS A5.23 F9P2-EG-G

**Type of flux:** Bonded

**Redrying of flux:** 200~300°Cx1h

**Polarity:** AC

**Packaging data**

Flux		Can		
PF-500	10x48	20kg		
Volume mm		240W, 350H, 240L		
Wire	φ mm	Coil		
US-521H	2.4	25kg	-	-
	3.2	25kg	-	-
	4.0	25kg	75kg	150kg
Volume mm		430W, 90H, 430L	740W, 110H, 740L	840W, 110H, 840L

**Composition (wire mass%)**

	Typical	Guaranty <sup>a</sup>
<b>C</b>	0.16	0.18
<b>Si</b>	0.21	0.30
<b>Mn</b>	1.19	0.30~1.50
<b>P</b>	0.002	0.010
<b>S</b>	0.001	0.010
<b>Ni</b>	<0.01	0.20
<b>Cr</b>	2.13	2.00~2.65
<b>Mo</b>	0.99	0.90~1.20
<b>V</b>	0.36	0.25~0.45
<b>Nb</b>	0.019	0.010~0.040
<b>Cu</b>	0.10	0.30

Note: <sup>a</sup> Single values are maximum.

**Composition (weld metal mass%)**

	Typical	Guaranty <sup>a</sup>
<b>C</b>	0.12	0.05~0.15
<b>Si</b>	0.15	0.05~0.35
<b>Mn</b>	1.14	0.50~1.30
<b>P</b>	0.003	0.010
<b>S</b>	0.001	0.010
<b>Ni</b>	<0.01	0.20
<b>Cr</b>	2.04	2.00~2.60
<b>Mo</b>	0.99	0.90~1.20
<b>V</b>	0.33	0.20~0.40
<b>Nb</b>	0.015	0.010~0.040
<b>Cu</b>	0.09	-

Note: <sup>a</sup> Single values are maximum.

**Weld mechanical properties**

	Typical	Guaranty
<b>0.2%YS (MPa)</b>	620	530min.
<b>TS (MPa)</b>	720	620min.
<b>El on 4d (%)</b>	23	16min.
<b>IV -18°C (J)</b>	150	-
<b>PWHT (°C×h)</b>	705°C×8h	705±15×8

**MF-29A/US-2CW****TRUSTARC™****Flux and wire combination for low C-2.25%Cr-W-V-Nb steel****Features:** - Applied for ASTM A335 Gr.23 and equivalents**Classification:** AWS -**Type of flux:** Fused**Polarity:** DCEP**Packaging data**

Flux	Mesh	Can	
MF-29A	48xD	25kg	
Volume mm		240W, 350H, 240L	
Wire	φ mm	Spool	Coil
US-2CW	1.6	20kg	-
	2.4	-	25kg
	3.2	-	25kg
	4.0	-	25kg
Volume mm		300W, 110H, 300L	430W, 90H, 430L

**Composition (wire mass%)**

	Typical	Guaranty <sup>a</sup>
<b>C</b>	0.04	0.15
<b>Si</b>	0.13	0.60
<b>Mn</b>	1.15	0.10~1.60
<b>P</b>	0.004	0.020
<b>S</b>	0.004	0.010
<b>Cu</b>	0.11	0.40
<b>Cr</b>	2.26	1.90~2.60
<b>Mo</b>	0.12	0.05~0.85
<b>W</b>	1.75	1.00~2.00
<b>V</b>	0.24	0.15~0.30
<b>Nb</b>	0.026	0.040

Note: <sup>a</sup> Single values are maximum.**Composition (weld metal mass%)**

	Typical	Guaranty <sup>a</sup>
<b>C</b>	0.04	0.15
<b>Si</b>	0.25	0.60
<b>Mn</b>	1.15	0.10~1.60
<b>P</b>	0.006	0.020
<b>S</b>	0.002	0.010
<b>Cu</b>	0.13	0.40
<b>Cr</b>	2.12	1.90~2.60
<b>Mo</b>	0.12	0.05~0.85
<b>W</b>	1.69	1.00~2.00
<b>V</b>	0.22	0.15~0.30
<b>Nb</b>	0.016	0.040

Note: <sup>a</sup> Single values are maximum.**Weld mechanical properties**

	Typical	Guaranty
<b>0.2%YS (MPa)</b>	520	300min.
<b>TS (MPa)</b>	620	510min.
<b>El on 4d (%)</b>	27	17min.
<b>IV 20°C (J)</b>	100	-
<b>PWHT (°Cxh)</b>	715x2	715x2

**PF-200S/US-90B91****Flux and wire combination for 9%Cr-1%Mo-V-Nb steel**

**Features:**

- Applied for ASTM A387 Gr.91 and equivalents
- Excellent creep rupture strength

**Classification:** AWS A5.23 F9PZ-EB91-B91

**Type of flux:** Bonded

**Redrying of flux:** 200~300°Cx1h

**Polarity:** AC

**Packaging data**

Flux	Mesh	Can
PF-200S	10x48	20kg
Volume mm		240W, 350H, 240L
Wire	φ mm	Coil
US-90B91	2.4	25kg
	3.2	25kg
Volume mm		430W, 90H, 430L

**Composition (wire mass%)**

	Typical	Guaranty <sup>a</sup>
<b>C</b>	0.11	0.07~0.13
<b>Si</b>	0.29	0.50
<b>Mn</b>	0.51	1.00
<b>P</b>	0.005	0.015
<b>S</b>	0.004	0.015
<b>Cu</b>	<0.01	0.10
<b>Ni</b>	0.14	1.00
<b>Cr</b>	8.95	8.5~10.5
<b>Mo</b>	1.00	0.85~1.15
<b>V</b>	0.19	0.15~0.25
<b>Al</b>	<0.002	0.04
<b>Nb</b>	0.06	0.02~0.10
<b>N</b>	0.04	0.03~0.07
<b>Mn+Ni</b>	0.65	1.40
<b>Co</b>	0.39	-

Note: <sup>a</sup>Single values are maximum.

**Composition (weld metal mass%)**

	Typical	Guaranty <sup>a</sup>
<b>C</b>	0.09	0.08~0.13
<b>Si</b>	0.25	0.80
<b>Mn</b>	0.66	1.20
<b>P</b>	0.005	0.010
<b>S</b>	0.005	0.010
<b>Cu</b>	0.01	0.25
<b>Ni</b>	0.12	0.80
<b>Cr</b>	9.01	8.0~10.5
<b>Mo</b>	1.01	0.85~1.20
<b>V</b>	0.19	0.15~0.25
<b>Al</b>	<0.01	0.04
<b>Nb</b>	0.05	0.02~0.10
<b>N</b>	0.04	0.02~0.07
<b>Mn+Ni</b>	0.78	1.40
<b>Co</b>	0.36	-

Note: <sup>a</sup>Single values are maximum.

**All-weld mechanical properties**

	Typical	Guaranty
<b>0.2%YS (MPa)</b>	600	538min.
<b>TS (MPa)</b>	730	621~758
<b>El on 4d (%)</b>	23	17min.
<b>PWHT (°Cxh)</b>	760x2	760±15x2

# PF-90B91/US-90B91

**TRUSTARC™****Flux and wire combination for 9%Cr-1%Mo-V-Nb steel**

**Features:**

- Applied for ASTM A387 Gr.91 and equivalents
- Excellent creep rupture strength

**Classification:** AWS A5.23 F9PZ-EB91-B91

**Type of flux:** Bonded

**Redrying of flux:** 200~300°Cx1h

**Polarity:** DCEP

**Packaging data**

Flux	Mesh	Can
PF-90B91	10x48	20kg
Volume mm		240W, 350H, 240L
Wire	φ mm	Coil
US-90B91	2.4	25kg
	3.2	25kg
Volume mm		430W, 90H, 430L

**Composition (wire mass%)**

	Typical	Guaranty <sup>a</sup>
<b>C</b>	0.11	0.07~0.13
<b>Si</b>	0.29	0.50
<b>Mn</b>	0.51	1.00
<b>P</b>	0.005	0.015
<b>S</b>	0.004	0.015
<b>Cu</b>	<0.01	0.10
<b>Ni</b>	0.14	1.00
<b>Cr</b>	8.95	8.5~10.5
<b>Mo</b>	1.00	0.85~1.15
<b>V</b>	0.19	0.15~0.25
<b>Al</b>	<0.002	0.04
<b>Nb</b>	0.06	0.02~0.10
<b>N</b>	0.04	0.03~0.07
<b>Mn+Ni</b>	0.65	1.40
<b>Co</b>	0.39	-

Note: <sup>a</sup>Single values are maximum.

**Composition (weld metal mass%)**

	Typical	Guaranty <sup>a</sup>
<b>C</b>	0.08	0.08~0.13
<b>Si</b>	0.26	0.80
<b>Mn</b>	0.72	1.20
<b>P</b>	0.005	0.010
<b>S</b>	0.005	0.010
<b>Cu</b>	0.01	0.25
<b>Ni</b>	0.12	0.80
<b>Cr</b>	8.93	8.0~10.5
<b>Mo</b>	1.01	0.85~1.20
<b>V</b>	0.18	0.15~0.25
<b>Al</b>	0.01	0.04
<b>Nb</b>	0.05	0.02~0.10
<b>N</b>	0.04	0.02~0.07
<b>Mn+Ni</b>	0.84	1.40
<b>Co</b>	0.36	-

Note: <sup>a</sup>Single values are maximum.

**All-weld mechanical properties**

	Typical	Guaranty
<b>0.2%YS (MPa)</b>	590	538min.
<b>TS (MPa)</b>	730	621~758
<b>El on 4d (%)</b>	25	17min.
<b>PWHT (°Cxh)</b>	760x2	760±15x2



**PF-200S/US-9Cb****Flux and wire combination for 9%Cr-1%Mo-V-Nb steel**

**Features:**

- Suitable for multi-pass butt welding of 9%Cr-1%Mo-V-Nb steel
- Excellent creep rupture strength

**Classification:** AWS A5.23 F10PZ-EG-G

**Type of flux:** Bonded

**Redrying of flux:** 200~300°Cx1h

**Polarity:** AC

**Packaging data**

Flux	Mesh	Can	
PF-200S	10x48	20kg	
Volume mm		240W, 350H, 240L	
Wire	φ mm	Spool	Coil
US-9Cb	1.2	20kg	-
	1.6	20kg	-
	2.4	-	25kg
	3.2	-	25kg
	4.0	-	25kg
Volume mm		300W, 110H, 300L	430W, 90H, 430L

**Composition (wire mass%)**

	Typical	Guaranty <sup>a</sup>
<b>C</b>	0.08	0.14
<b>Si</b>	0.13	0.30
<b>Mn</b>	1.73	2.00
<b>P</b>	0.005	0.020
<b>S</b>	0.003	0.020
<b>Ni</b>	0.57	1.00
<b>Cr</b>	8.81	8.00~10.50
<b>Mo</b>	0.90	0.80~1.20
<b>Nb</b>	0.05	0.10
<b>V</b>	0.23	0.50
<b>Cu</b>	0.02	0.15

Note: <sup>a</sup>Single values are maximum.

**Composition (weld metal mass%)**

	Typical	Guaranty <sup>a</sup>
<b>C</b>	0.06	0.12
<b>Si</b>	0.12	0.60
<b>Mn</b>	1.58	2.00
<b>P</b>	0.008	0.025
<b>S</b>	0.004	0.025
<b>Ni</b>	0.55	1.00
<b>Cr</b>	8.31	8.00~10.50
<b>Mo</b>	0.88	0.80~1.20
<b>Nb</b>	0.03	0.15
<b>V</b>	0.21	0.50

Note: <sup>a</sup>Single values are maximum.

**Weld mechanical properties**

	Typical	Guaranty
<b>0.2%YS (MPa)</b>	580	607min.
<b>TS (MPa)</b>	710	690~827
<b>El on 4d (%)</b>	24	16min.
<b>IV 0°C (J)</b>	68	-
<b>PWHT (°Cxh)</b>	740x8	745±15x1

**PF-200S/US-12CRSD****TRUSTARC™**

Flux and wire combination for 9-12%Cr-W-V-Nb steel

**Features:** • Applied for ASTM A335 Gr. P92 and equivalents**Classification:** AWS -**Type of flux:** Bonded**Redrying of flux:** 200~300°Cx1h**Polarity:** DCEP**Packaging data**

Flux	Mesh	Can	
PF-200S	10x48	20kg	
Volume mm		240W, 350H, 240L	
Wire	φ mm	Spool	Coil
US-12CRSD	1.2	20kg	-
	1.6	20kg	-
	2.4	-	25kg
Volume mm		300W, 110H, 300L	430W, 90H, 430L

**Composition (wire mass%)**

	Typical	Guaranty <sup>a</sup>
<b>C</b>	0.07	0.15
<b>Si</b>	0.35	0.50
<b>Mn</b>	0.74	1.00
<b>P</b>	0.004	0.020
<b>S</b>	0.003	0.010
<b>Cu</b>	0.01	1.30
<b>Ni</b>	0.51	0.80
<b>Cr</b>	9.92	9.50~12.00
<b>Mo</b>	0.35	0.10~0.70
<b>W</b>	1.45	1.00~2.00
<b>V</b>	0.21	0.05~0.35
<b>Nb</b>	0.035	0.01~0.10
<b>Co</b>	1.01	0.80~1.20

Note: <sup>a</sup>Single values are maximum.**Composition (weld metal mass%)**

	Typical	Guaranty <sup>a</sup>
<b>C</b>	0.06	0.15
<b>Si</b>	0.24	0.60
<b>Mn</b>	0.88	1.50
<b>P</b>	0.008	0.010
<b>S</b>	0.004	0.010
<b>Cu</b>	0.02	0.80
<b>Ni</b>	0.52	1.50
<b>Cr</b>	9.48	8.60~13.00
<b>Mo</b>	0.32	0.10~0.70
<b>W</b>	1.36	1.00~2.00
<b>V</b>	0.20	0.35
<b>Nb</b>	0.030	0.080
<b>Co</b>	0.98	0.50~1.80
<b>N</b>	0.04	0.10

Note: <sup>a</sup>Single values are maximum.**Weld mechanical properties**

	Typical	Guaranty
<b>0.2%YS (MPa)</b>	650	440min.
<b>TS (MPa)</b>	780	621min.
<b>El on 4d (%)</b>	23	17min.
<b>IV 20°C (J)</b>	30	-
<b>PWHT (°Cxh)</b>	745x8	750±15x1

# **For Stainless Steel**

## **Welding Consumables for**

**SMAW**

**FCAW**

**GMAW**

**GTAW**

# SMAW, FCAW, GMAW, GTAW

## A guide for selecting welding consumables (Product names)

Steel type	Key note for application	SMAW
304	▪ General	<b>NC-38</b>
304L	▪ Cryogenic temperature	<b>NC-38LT</b>
	▪ Low carbon 0.04% max.	<b>NC-38L</b>
	▪ High temperature service and solution treatment	<b>NC-38L</b>
	▪ Low Cr (VI) in fume	-
304H	▪ High temperature	<b>NC-38H</b>
Dissimilar metals	▪ General	<b>NC-39, NC-39L NC-39MoL NC-32</b>
	▪ Solution treatment	-
	▪ Low Cr (VI) in fume	-
316	▪ General	<b>NC-36</b>
316L	▪ Cryogenic temperature	<b>NC-36LT</b>
	▪ Low carbon (0.04% max.)	<b>NC-36L</b>
	▪ Solution treatment	<b>NC-36L</b>
	▪ Low Cr (VI) in fume	-
316H	▪ High temperature	-
316L Mod.	▪ Urea (Low ferrite content)	<b>NC-316MF</b>
317L	▪ Low carbon (0.04% max.)	<b>NC-317L</b>
347	▪ General	<b>NC-37</b>
	▪ Low carbon	<b>NC-37L</b>
	▪ High temperature	<b>NC-37</b>
321	▪ General	<b>NC-37</b>
	▪ High temperature	<b>NC-37</b>
310S	▪ General	<b>NC-30</b>
Duplex	▪ Normal duplex	<b>NC-2209</b>
	▪ Super duplex	<b>NC-2594</b>
	▪ Lean duplex	-
410	▪ General	<b>CR-40</b>
405, 409	▪ Overlaying in cladding	<b>CR-40Cb</b>
-	▪ Low carbon martensite	-
409,430,436,410L	▪ Car exhaust system	-

	<b>FCAW</b>	<b>GMAW</b>	<b>GTAW</b>
	DW-308, DW-308LP	MG-S308	TG-S308
	DW-308LT	-	TG-S308L
	DW-308L DW-308LP	MG-S308LS	TG-S308L TG-X308L
	DW-308LH	-	-
	DW-308L-XR DW-308LP-XR	-	-
	DW-308H	-	-
	DW-309, DW-309L DW-309MoL, DW-309LP DW-309MoLP, DW-312	MG-S309 MG-S309LS	TG-S309, TG-S309L TG-S309MoL TG-X309L
	DW-309LH	-	-
	DW-309L-XR DW-309LP-XR	-	-
	DW-316LP	-	TG-S316
	DW-316LT	-	TG-S316L
	DW-316L, DW-316LP	MG-S316LS	TG-S316L, TG-X316L
	DW-316LH	-	-
	DW-316L-XR DW-316LP-XR	-	-
	DW-316H	-	-
	-	-	NO4051 TG-S310MF
	DW-317L, DW-317LP	-	TG-S317L
	DW-347	-	TG-S347, TG-X347
	-	-	TG-S347L
	-	-	TG-S347
	DW-347	-	TG-S347
	-	-	TG-S347
	DW-310	-	TG-S310
	DW-2209, DW-329AP	-	TG-S2209
	DW-2594	-	TG-S2594
	DW-2307	-	-
	-	MG-S410	TG-S410
	DW-410Cb	-	TG-S410Cb
	MX-A410NiMo	-	-
	MX-A430M	-	-

# SMAW, FCAW

## Tips for better welding results

### SMAW

- (1) Use proper welding currents because the use of an excessive current causes overheating electrodes and thereby welding usability and weld metal mechanical properties can be deteriorated.
- (2) Keep the arc as short as possible.
- (3) Control the weaving width of electrode within two and a half times the diameter of the electrode.

### FCAW

#### 1. Features:

- (1) DW stainless flux-cored wires are cost-effective wires because of high welding efficiency with the deposition rate 2-4 times as high as those of stick electrodes as shown in Fig. 1 and deposition efficiency of about 90%.
- (2) DW stainless wires offer a wider range of current and voltage in comparison with solid wire as shown in Fig. 2, which facilitates easier application for both semi-automatic and automatic welding.
- (3) DW stainless series has excellent usability and weldability with stable arc, low spatter, good slag removal, smooth bead appearance, and high X-ray soundness.

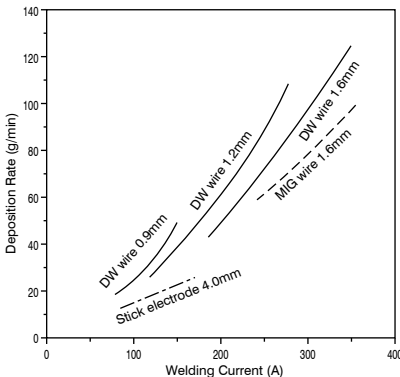

Fig. 1 Deposition rate as per welding current

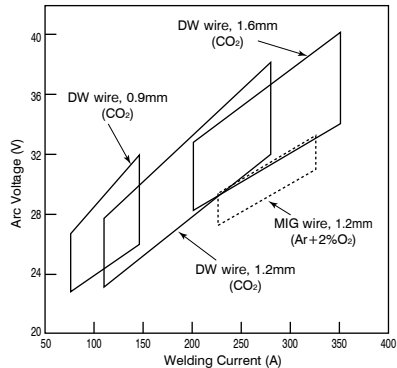

Fig. 2 Proper ranges of welding current and arc voltage

## 2. Notes on usage

(1) Welding power source:

Use a DC power source with constant voltage and the polarity DCEP. Inverter-type welding power sources can also be used. When the use of a certain pulsed arc power source causes much spatter, use the wire with ordinary currents, turning off the pulse switch.

(2) Shielding gas:

Use CO<sub>2</sub> for shielding gas for general applications. Ar-CO<sub>2</sub> mixtures with 20-50% CO<sub>2</sub> can also be used, but compared with CO<sub>2</sub>, porosity (pit and blowhole) is apt to occur. The proper flow rate of shielding gas is 20-25 liter/min.

(3) Wire extension:

Keep the wire extension at about 15 mm for 0.9-mm wire and 15-20 mm for 1.2- and 1.6-mm wire. The use of a shorter wire extension may cause pit and worm-tracking porosity. The wire extension in welding with an Ar-CO<sub>2</sub> mixture should be 5 mm longer than in use of CO<sub>2</sub>.

(4) Protection against wind:

When wind velocity at the vicinity of an arc is more than 1 m/sec., blowhole is apt to occur, and dissolution of nitrogen into the weld metal may deteriorate slag removal and decrease the ferrite content of the weld metal, thereby causing hot cracking. To prevent these problems, use an adequate shielding gas flow rate and a windscreen.

(5) Welding fumes:

Flux-cored wires generate much more welding fumes in terms of the amount of fumes at unit time in comparison with that of stick electrodes. To protect welders from harmful welding fumes, be sure to use a local ventilator and an appropriate respirator.

(6) Storage of wire:

Once a DW stainless wire picked up moisture, it cannot be dried at high temperatures, unlike stick electrodes. If a DW wire was left in a wire feeder in a high-temperature high-humidity atmosphere in summer season, a wet environment in rainy season or a dewfall environment at night in winter season, the use of it may cause pit and worm-tracking porosity due to moisture pick up. Once a wire was unpacked, the wire should be kept in an area of low humidity, taking appropriate preventive measures against dewfall water and dust.

### 3. Applications

(1) Butt welding:

Applicable plate thicknesses are 2 mm or larger with a 1.2mm wire and 5 mm or larger with a 1.6mm wire in flat position. P-series wires enable to weld thin plates with 3-4 mm thickness in vertical position. One-side welding can be applied for similar-shape grooves in flat, horizontal and vertical positions by using a backing material of FB-B3 (T size). In this case, the root opening should be about 3-4 mm to obtain good reverse beads.

(2) Horizontal fillet welding:

Proper welding speeds are approximately 30-70 cm/min in horizontal fillet welding. With a 309 type wire, dissimilar-metal welding of stainless steel to carbon steel can be done in the same welding condition as used for welding stainless steels. However to secure the ferrite content of weld metal, welding currents should be 200A or lower and welding speeds should be 40 cm/min or slower with a 1.2mm wire.

(3) Overlaying and joining of clad steels:

The 1st layer of overlaying onto carbon steel should be welded with a 309 (or 309MoL) type wire by the half lapping method. In case where the dilution by the base metal is excessive, the ferrite content of the weld metal decreases and thereby hot cracking may occur. Therefore, it is important to use appropriate welding conditions to control the dilution particularly for the first layer. In order to obtain the proper dilution ratio, welding currents should be 200A or lower and welding speeds should be 20-40 cm/min with a 1.2mm wire. With a 1.6mm wire, use welding currents in the 200-250 range and welding speeds in the 20-30 cm/min range. Refer to Fig. 3.

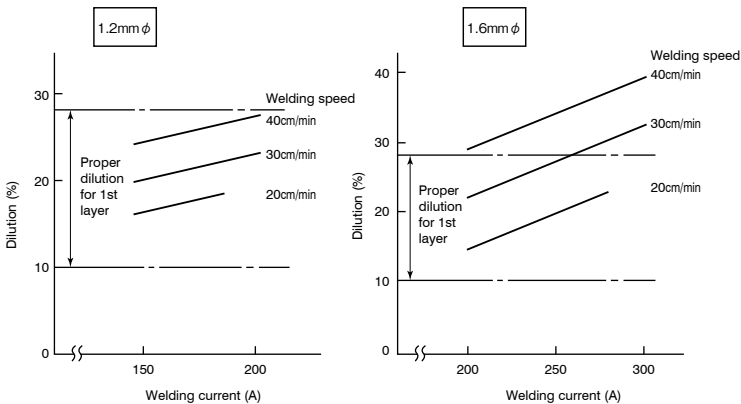

Fig. 3 Dilution ratios as per welding currents



## **GMAW**

- (1) Polarity:  
DCEP is suitable.
- (2) Shielding gas:  
98% Ar-2%O<sub>2</sub> mixture is recommended for general applications. Proper gas flow rates range in 20-25 l/min. Ar-CO<sub>2</sub> mixture is not suitable for low carbon stainless steel (Type 304L) because the carbon content of deposited metal increases.
- (3) Arc length:  
GMAW of stainless steel generally uses the spray arc transfer mode due to lower spatter generation. Adjust arc voltage so that arc length becomes 4-6 mm. When arc length is excessively short, blowholes are apt to occur. Inversely, when arc length is excessively long, the wetting of deposited metal on the base metal becomes poor.
- (4) Protection against wind:  
GMAW is likely to be influenced by wind and thereby blowholes may occur. Use a windscreen to protect the arcing area against wind when the wind velocity near the arc is 0.5m/sec or more.
- (5) Pulsed arc welding:  
In pulsed arc welding, a stable spray arc can be obtained even with low welding currents. Pulsed arc is suitable for overlaying, welding of thin plates and vertical welding.

## **GTAW**

- (1) Polarity:  
DCEN is suitable.
- (2) Shielding gas:  
Argon gas is mainly used for shielding. Suitable flow rates of shielding gas are in the range of 7-15 l/min. at 100-200A of welding current and 12-20 l/min. at 200-300A in manual GTAW.
- (3) Torch:  
Two types of GTAW torches are available. One has a gas lens, another has no gas lens. A torch with a gas lens provides better shielding effect preventing the weld bead from oxidation since the gas lens can provide a regular gas flow.
- (4) Tungsten electrode extension:  
Proper tungsten electrode extensions are generally in the range of 4-5 mm. In the case where shielding effect tends to be lower as in welding corner joint, tungsten extension is recommended to be 2-3 mm. In welding of deep groove joints, tungsten extension should be longer as 5-6 mm.
- (5) Arc length:  
Proper arc lengths are in the range of 1-3 mm. When it is excessively long, the shielding effect becomes poor.
- (6) One-side welding without backing materials:  
In the case of one-side welding without backing materials, adopt back shielding in order to prevent oxidization of the penetration bead. However, with a flux-cored filler rod for GTAW, sound penetration bead can be obtained without back shielding.
- (7) Fully austenitic type filler wires:  
With a fully austenitic type filler wire (e.g., TG-S310, 310MF), use lower welding currents and welding speeds to prevent hot cracking.

## Ferrite content measuring methods for austenitic stainless steel weld metal

Method	Principles of measuring ferrite content
Structure Diagram:	Calculating Ni equivalent and Cr equivalent of the chemical composition of a test specimen and reading the crossing point of the two equivalents in a structure diagram. Three structure diagrams are available: Schaeffler diagram, DeLong diagram and WRC diagram. See Figs. 1, 2 and 3.
Ferrite Indicator:	Comparing the magnetic attraction between a standard ferrite percent insert and a test specimen
Ferrite Scope:	Measuring a change of magnetic induction affected by the ferrite content of a test specimen
Magne Gage:	Measuring the pull off force necessary to detach a standard permanent magnet from a test specimen
Point Counting:	Calculating the area percentage of ferrite in the microstructure of a test specimen, by using an optical microscope

Fig. 1 Schaeffler Diagram

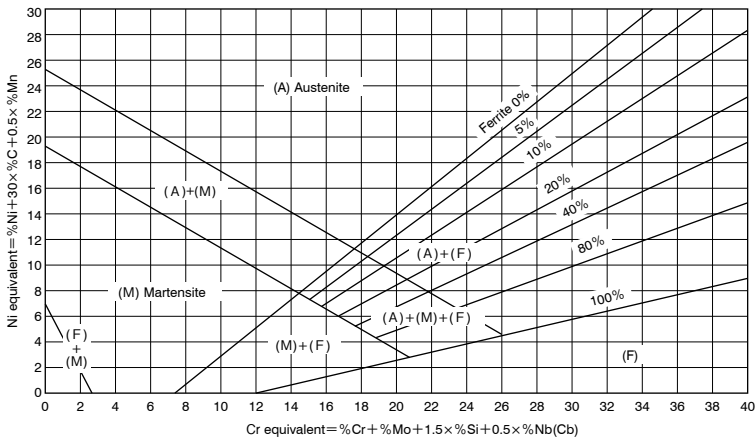

**Fig. 2 DeLong Diagram**

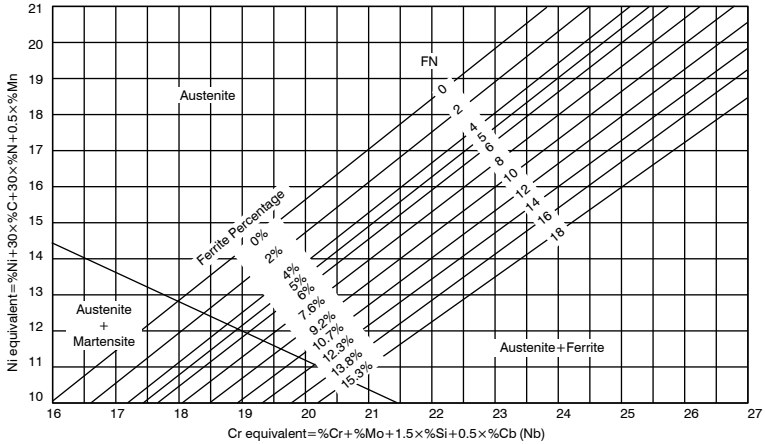

**Fig. 3 WRC Diagram**

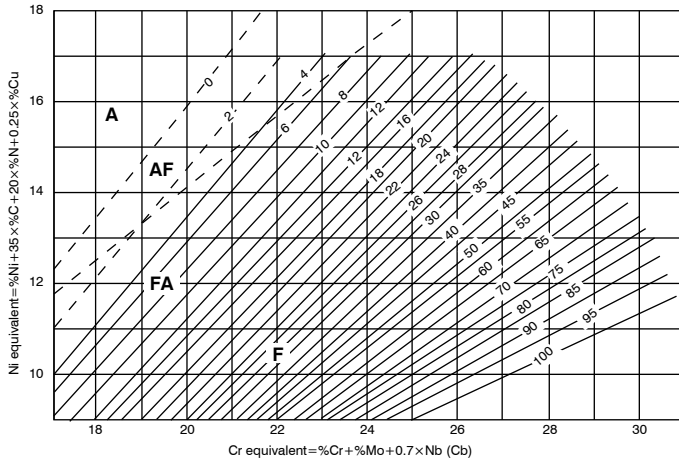

A, AF, FA, F stand for solidification modes  
 A : Austenitic single phase (  $\gamma$  )  
 AF : Primary phase (  $\gamma$  ) + Eutectic Ferrite (  $\delta$  )  
 FA : Primary phase (  $\delta$  ) + Peritectic / Eutectic phase (  $\gamma$  )  
 F :  $\delta$  Single phase Solidification

## Stick electrode

**Features:** ▪ Applicable for 304 type steel

**Classification:** AWS A5.4 E308-16

**Redrying Conditions:** 150~200°Cx0.5~1h

**Identification color:** 1st Yellow

**Polarity:** AC, DCEP

## Welding Positions:

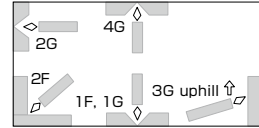

## Packaging data

φ mm	Length mm	kg/pack	kg/carton	g/piece	carton mm
2.0	250	2	20	11	300W, 125H, 280L
2.6	300	2	20	20	300W, 95H, 330L
3.2	350	5	20	36	175W, 115H, 380L
4.0	350	5	20	55	175W, 115H, 380L
5.0	350	5	20	82	175W, 115H, 380L

## Composition (all-weld metal mass%)

	Typical (AC)	Guaranty <sup>a</sup>
<b>C</b>	0.06	0.08
<b>Si</b>	0.37	1.00
<b>Mn</b>	1.5	0.5~2.5
<b>P</b>	0.03	0.04
<b>S</b>	<0.01	0.03
<b>Ni</b>	9.4	9.0~11.0
<b>Cr</b>	20.0	18.0~21.0
<b>Mo</b>	0.16	0.75
<b>Cu</b>	0.08	0.75

Note: <sup>a</sup>Single values are maximum.

## Welding parameters (A)

φ mm	1F, 1G, 2F, 2G	3G uphill, 4G
2.0	50~75	45~65
2.6	75~95	70~90
3.2	85~120	80~115
4.0	110~160	90~140
5.0	150~200	-

## All-weld mechanical properties

	Typical (AC)	Guaranty
<b>0.2%YS (MPa)</b>	410	-
<b>TS (MPa)</b>	600	552min.
<b>El on 4d (%)</b>	46	30min.
<b>IV 0°C (J)</b>	74	-

## Approvals

<b>ABS</b>	MG (AWS A5.4 E308-16)
<b>DNV</b>	VL308
<b>NK<sup>a)</sup></b>	KD308

Note: <sup>a)</sup> AC

## Stick electrode

- Features:**
- Applicable for 304 type steel for high temperature
  - Excellent mechanical properties at high temperatures

**Classification:** AWS A5.4 E308H-16

**Redrying Conditions:** 150~200°Cx0.5~1h

**Identification color:** 1st Yellow

**Polarity:** AC, DCEP

## Welding Positions:

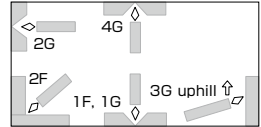

## Packaging data

$\phi$ mm	Length mm	kg/pack	kg/carton	g/piece	carton mm
2.6	300	2	20	20	300W, 100H, 330L
3.2	350	5	20	36	175W, 125H, 380L
4.0	350	5	20	54	175W, 125H, 380L
5.0	350	5	20	80	175W, 130H, 380L

## Composition (all-weld metal mass%)

	Typical (AC)	Guaranty <sup>a</sup>
<b>C</b>	0.06	0.04~0.08
<b>Si</b>	0.45	1.00
<b>Mn</b>	1.95	0.5~2.5
<b>P</b>	0.02	0.04
<b>S</b>	<0.01	0.03
<b>Ni</b>	9.5	9.0~11.0
<b>Cr</b>	19.5	18.0~21.0
<b>Mo</b>	0.05	0.75
<b>Cu</b>	0.07	0.75

## Welding parameters (A)

$\phi$ mm	1F, 1G, 2F, 2G	3G uphill, 4G
2.6	50~85	45~80
3.2	70~115	65~110
4.0	95~145	85~135
5.0	135~180	-

Note: <sup>a</sup> Single values are maximum.

## All-weld mechanical properties

	Typical (AC)	Guaranty
<b>0.2%YS (MPa)</b>	403	-
<b>TS (MPa)</b>	572	552min.
<b>El on 4d (%)</b>	48	30min.
<b>IV 0°C (J)</b>	79	-

## Stick electrode

**Features:** • Applicable for 304L type steel

**Classification:** AWS A5.4 E308L-16

**Redrying Conditions:** 150~200°Cx0.5~1h

**Identification color:** 1st Red

**Polarity:** AC, DCEP

## Welding Positions:

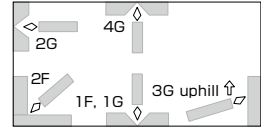

## Packaging data

φ mm	Length mm	kg/pack	kg/carton	g/piece	carton mm
2.0	250	2	20	11	300W, 125H, 280L
2.6	300	2	20	20	300W, 100H, 330L
3.2	350	5	20	36	175W, 115H, 380L
4.0	350	5	20	55	175W, 130H, 380L
5.0	350	5	20	82	175W, 130H, 380L

## Composition (all-weld metal mass%)

	Typical (AC)	Guaranty <sup>a</sup>
<b>C</b>	0.03	0.04
<b>Si</b>	0.38	1.00
<b>Mn</b>	1.5	0.5~2.5
<b>P</b>	0.02	0.04
<b>S</b>	<0.01	0.03
<b>Ni</b>	9.6	9.0~11.0
<b>Cr</b>	20.3	18.0~21.0
<b>Mo</b>	0.14	0.75
<b>Cu</b>	0.05	0.75

Note: <sup>a</sup>Single values are maximum.

## Welding parameters (A)

φ mm	1F, 1G, 2F, 2G	3G uphill, 4G
2.0	50~75	45~65
2.6	75~95	70~90
3.2	85~120	80~115
4.0	110~160	90~140
5.0	150~200	-

## All-weld mechanical properties

	Typical (AC)	Guaranty
<b>0.2%YS (MPa)</b>	410	-
<b>TS (MPa)</b>	580	518min.
<b>El on 4d (%)</b>	48	30min.
<b>IV 0°C (J)</b>	78	-

## Approvals

<b>LR</b>	304L m (CHEM)
<b>BV</b>	UP (E308L-16)
<b>DNV</b>	VL308L
<b>NK</b>	KD308L

## Stick electrode

**Features:** • Suitable for 18%Cr-8%Ni steel for cryogenic temperature service

**Classification:** AWS A5.4 E308L-16

**Redrying Conditions:** 150~200°Cx0.5~1h

**Identification color:** 1st Red, 2nd Yellow

**Polarity:** AC, DCEP

## Welding Positions:

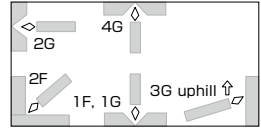

## Packaging data

φ mm	Length mm	kg/pack	kg/carton	g/piece	carton mm
2.6	300	2	20	18	300W, 100H, 330L
3.2	350	5	20	33	175W, 115H, 380L
4.0	350	5	20	51	175W, 130H, 380L
5.0	350	5	20	79	175W, 130H, 380L

## Composition (all-weld metal mass%)

	Typical (AC)	Guaranty <sup>a</sup>
<b>C</b>	0.03	0.04
<b>Si</b>	0.46	1.00
<b>Mn</b>	2.2	0.5~2.5
<b>P</b>	0.02	0.04
<b>S</b>	<0.01	0.03
<b>Ni</b>	10.3	9.0~11.0
<b>Cr</b>	18.8	18.0~21.0
<b>Mo</b>	0.05	0.75
<b>Cu</b>	0.05	0.75

Note: <sup>a</sup> Single values are maximum.

## Welding parameters (A)

φ mm	1F, 1G, 2F, 2G	3G uphill, 4G
2.6	50~85	45~80
3.2	70~115	65~110
4.0	95~145	85~130
5.0	135~180	-

## All-weld mechanical properties

	Typical (AC)	Guaranty
<b>0.2%YS (MPa)</b>	370	-
<b>TS (MPa)</b>	540	518min.
<b>EI on 4d (%)</b>	51	35min.
<b>IV -196°C (J)</b>	52	34min.

## Approvals

<b>ABS</b>	MG (AWS 5.4 E308L-16)
<b>LR</b>	304L m (CRYO)
<b>DNV</b>	VL308L, MG
<b>BV</b>	308L BT
<b>NK<sup>a)</sup></b>	KD308

Note: <sup>a)</sup> AC

## Stick electrode

**Features:** ▪ Suitable for dissimilar-metal joint and underlaying on ferritic steels

**Classification:** AWS A5.4 E309-16

**Redrying Conditions:** 150~200°Cx0.5~1h

**Identification color:** 1st Black, 2nd White

**Polarity:** AC, DCEP

## Welding Positions:

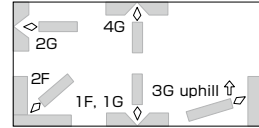

## Packaging data

φ mm	Length mm	kg/pack	kg/carton	g/piece	carton mm
2.0	250	2	20	11	300W, 125H, 280L
2.6	300	2	20	20	300W, 100H, 330L
3.2	350	5	20	36	175W, 115H, 380L
4.0	350	5	20	55	175W, 115H, 380L
5.0	350	5	20	82	175W, 115H, 380L

## Composition (all-weld metal mass%)

	Typical (AC)	Guaranty <sup>a</sup>
<b>C</b>	0.07	0.15
<b>Si</b>	0.40	1.00
<b>Mn</b>	1.0	0.5~2.5
<b>P</b>	0.03	0.04
<b>S</b>	<0.01	0.03
<b>Ni</b>	13.4	12.0~14.0
<b>Cr</b>	23.9	22.0~25.0
<b>Mo</b>	0.21	0.75
<b>Cu</b>	0.12	0.75

Note: <sup>a</sup> Single values are maximum.

## Welding parameters (A)

φ mm	1F, 1G, 2F, 2G	3G uphill, 4G
2.0	50~75	45~65
2.6	75~95	70~90
3.2	85~120	80~115
4.0	110~160	90~140
5.0	150~200	-

## All-weld mechanical properties

	Typical (AC)	Guaranty
<b>0.2%YS (MPa)</b>	410	-
<b>TS (MPa)</b>	590	552min.
<b>EI on 4d (%)</b>	39	30min.
<b>IV 0°C (J)</b>	62	-

## Approvals

<b>ABS</b>	MG (AWS 5.4 E309-16)
<b>LR</b>	SS/CMn m (CHEM)
<b>DNV</b>	VL309, MG
<b>BV</b>	UP (E309-16)
<b>NK<sup>a)</sup></b>	KD309
<b>CCS</b>	AS2-B

Note: <sup>a)</sup> AC



## Stick electrode

**Features:** • Suitable for dissimilar-metal joint and underlaying on ferritic steels

**Classification:** AWS A5.4 E309L-16

**Redrying Conditions:** 150~200°Cx0.5~1h

**Identification color:** 1st Yellow green, 2nd Blue white

**Polarity:** AC, DCEP

## Welding Positions:

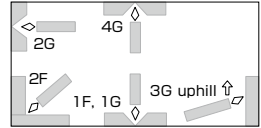

## Packaging data

φ mm	Length mm	kg/pack	kg/carton	g/piece	carton mm
2.0	250	2	20	11	300W, 125H, 280L
2.6	300	2	20	20	300W, 95H, 330L
3.2	350	5	20	36	175W, 125H, 380L
4.0	350	5	20	55	175W, 115H, 380L
5.0	350	5	20	82	175W, 115H, 380L

## Composition (all-weld metal mass%)

	Typical (AC)	Guaranty <sup>a</sup>
<b>C</b>	0.04	0.04
<b>Si</b>	0.42	1.00
<b>Mn</b>	1.6	0.5~2.5
<b>P</b>	0.03	0.04
<b>S</b>	<0.01	0.03
<b>Ni</b>	13.3	12.0~14.0
<b>Cr</b>	23.8	22.0~25.0
<b>Mo</b>	0.18	0.75
<b>Cu</b>	0.09	0.75

Note: <sup>a</sup>Single values are maximum.

## Welding parameters (A)

φ mm	1F, 1G, 2F, 2G	3G uphill, 4G
2.0	50~75	45~65
2.6	75~95	70~90
3.2	85~120	80~115
4.0	110~160	90~140
5.0	150~200	-

## All-weld mechanical properties

	Typical (AC)	Guaranty
<b>0.2%YS (MPa)</b>	410	-
<b>TS (MPa)</b>	560	518min.
<b>El on 4d (%)</b>	42	30min.
<b>IV 0°C (J)</b>	67	-

## Approvals

<b>ABS</b>	MG (AWS 5.4 E309L-16)
<b>LR</b>	SS/CMn m (CHEM)
<b>DNV</b>	VL309L, MG
<b>BV</b>	UP (E309L-16)
<b>NK</b>	KD309L

## Stick electrode

**Features:** ▪ Suitable for dissimilar-metal joint and underlaying on ferritic steels

**Classification:** AWS A5.4 E309LMO-16

**Redrying Conditions:** 150~200°Cx0.5~1h

**Identification color:** 1st Silver, 2nd Blue

**Polarity:** AC, DCEP

## Welding Positions:

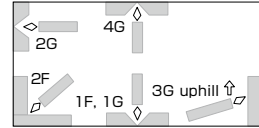

## Packaging data

φ mm	Length mm	kg/pack	kg/carton	g/piece	carton mm
2.6	300	2	20	19	300W, 95H, 330L
3.2	350	5	20	33	175W, 135H, 380L
4.0	350	5	20	54	175W, 130H, 380L
5.0	350	5	20	85	175W, 130H, 380L

## Composition (all-weld metal mass%)

	Typical (AC)	Guaranty <sup>a</sup>
<b>C</b>	0.03	0.04
<b>Si</b>	0.51	1.00
<b>Mn</b>	1.3	0.5~2.5
<b>P</b>	0.02	0.04
<b>S</b>	<0.01	0.03
<b>Ni</b>	12.9	12.0~14.0
<b>Cr</b>	23.5	22.0~25.0
<b>Mo</b>	2.1	2.0~3.0
<b>Cu</b>	0.07	0.75

Note: <sup>a</sup> Single values are maximum.

## Welding parameters (A)

φ mm	1F, 1G, 2F, 2G	3G uphill, 4G
2.6	50~85	45~80
3.2	70~115	65~110
4.0	95~145	85~135
5.0	135~180	-

## All-weld mechanical properties

	Typical (AC)	Guaranty
<b>0.2%YS (MPa)</b>	450	-
<b>TS (MPa)</b>	630	518min.
<b>EI on 4d (%)</b>	41	30min.
<b>IV 0°C (J)</b>	65	-

## Approvals

<b>ABS</b>	MG KD309Mo
<b>NK</b>	

## Stick electrode

**Features:** • Suitable for dissimilar joint between carbon steel and stainless steel rich in carbon or nickel.

**Classification:** AWS A5.4 E312-16

**Redrying Conditions:** 150~250°Cx0.5-1h

**Identification color:** 1st Green, 2nd Red

**Polarity:** AC, DCEP

## Welding Positions:

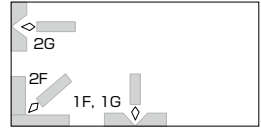

## Packaging data

φ mm	Length mm	kg/pack	kg/carton	g/piece	carton mm
3.2	300	2	20	27	300W, 110H, 330L
4.0	350	5	20	49	175W, 120H, 380L
5.0	350	5	20	76	175W, 120H, 380L

## Composition (all-weld metal mass%)

	Typical (AC)	Guaranty <sup>a</sup>
<b>C</b>	0.13	0.15
<b>Si</b>	0.62	1.00
<b>Mn</b>	1.2	0.5~2.5
<b>P</b>	0.01	0.04
<b>S</b>	<0.01	0.03
<b>Ni</b>	9.6	8.0~10.5
<b>Cr</b>	28.2	28.0~32.0
<b>Mo</b>	0.01	0.75
<b>Cu</b>	0.05	0.75

## Welding parameters (A)

φ mm	1F, 1G, 2F, 2G
3.2	70~115
4.0	95~145
5.0	135~180

Note: <sup>a</sup> Single values are maximum.

## All-weld mechanical properties

	Typical (AC)	Guaranty
<b>0.2%YS (MPa)</b>	624	-
<b>TS (MPa)</b>	785	655min.
<b>El on 4d (%)</b>	20	22min.

## Stick electrode

**Features:** • Applicable for 316 type steel

**Classification:** AWS A5.4 E316-16

**Redrying Conditions:** 150~200°Cx0.5~1h

**Identification color:** 1st White

**Polarity:** AC, DCEP

## Welding Positions:

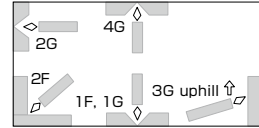

## Packaging data

φ mm	Length mm	kg/pack	kg/carton	g/piece	carton mm
2.0	250	2	20	11	300W, 130H, 280L
2.6	300	2	20	20	300W, 100H, 330L
3.2	350	5	20	36	175W, 115H, 380L
4.0	350	5	20	55	175W, 115H, 380L
5.0	350	5	20	82	175W, 115H, 380L

## Composition (all-weld metal mass%)

	Typical (AC)	Guaranty <sup>a</sup>
<b>C</b>	0.04	0.08
<b>Si</b>	0.35	1.00
<b>Mn</b>	1.5	0.5~2.5
<b>P</b>	0.03	0.04
<b>S</b>	<0.01	0.03
<b>Ni</b>	12.0	11.0~14.0
<b>Cr</b>	19.2	17.0~20.0
<b>Mo</b>	2.2	2.0~3.0
<b>Cu</b>	0.10	0.75

Note: <sup>a</sup>Single values are maximum.

## Welding parameters (A)

φ mm	1F, 1G, 2F, 2G	3G uphill, 4G
2.0	50~75	45~65
2.6	75~95	70~90
3.2	85~120	80~115
4.0	110~160	90~140
5.0	150~200	-

## All-weld mechanical properties

	Typical (AC)	Guaranty
<b>0.2%YS (MPa)</b>	410	-
<b>TS (MPa)</b>	570	518min.
<b>EI on 4d (%)</b>	46	30min.
<b>IV 0°C (J)</b>	80	-

## Approvals

NK	KD316

## Stick electrode

**Features:** - Applicable for 316L type steel  
**Classification:** AWS A5.4 E316L-16  
**Redrying Conditions:** 150~200°Cx0.5~1h  
**Identification color:** 1st Green  
**Polarity:** AC, DCEP

## Welding Positions:

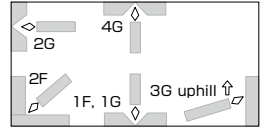

## Packaging data

φ mm	Length mm	kg/pack	kg/carton	g/piece	carton mm
2.0	250	2	20	11	300W, 130H, 280L
2.6	300	2	20	20	300W, 100H, 330L
3.2	350	5	20	36	175W, 110H, 380L
4.0	350	5	20	55	175W, 115H, 380L
5.0	350	5	20	82	175W, 115H, 380L

## Composition (all-weld metal mass%)

	Typical (AC)	Guaranty <sup>a</sup>
<b>C</b>	0.03	0.04
<b>Si</b>	0.36	1.00
<b>Mn</b>	1.5	0.5~2.5
<b>P</b>	0.03	0.04
<b>S</b>	<0.01	0.03
<b>Ni</b>	12.0	11.0~14.0
<b>Cr</b>	19.4	17.0~20.0
<b>Mo</b>	2.2	2.0~3.0
<b>Cu</b>	0.11	0.75

Note: <sup>a</sup>Single values are maximum.

## Welding parameters (A)

φ mm	1F, 1G, 2F, 2G	3G uphill, 4G
2.0	50~75	45~65
2.6	75~95	70~90
3.2	85~120	80~115
4.0	110~160	90~140
5.0	150~200	-

## All-weld mechanical properties

	Typical (AC)	Guaranty
<b>0.2%YS (MPa)</b>	420	-
<b>TS (MPa)</b>	580	483min.
<b>EI on 4d (%)</b>	45	30min.
<b>IV 0°C (J)</b>	83	-

## Approvals

<b>ABS</b>	MG (AWS 5.4 E316L-16)
<b>LR</b>	316L m (CHEM)
<b>DNV</b>	VL316L, MG
<b>BV</b>	UP (E316L-16)
<b>NK<sup>a</sup></b>	KD316L

Note: <sup>a</sup> AC

## Stick electrode

**Features:** ▪ Suitable for 18%Cr-12%Ni-2%Mo steel for cryogenic temperature service

**Welding Positions:**

**Classification:** AWS A5.4 E316L-16

**Redrying Conditions:** 150~200°Cx 0.5~1h

**Identification color:** 1st Green

**Polarity:** AC, DCEP

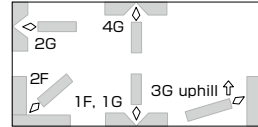
**Packaging data**

φ mm	Length mm	kg/pack	kg/carton	g/piece	carton mm
2.6	300	2	20	19	300W, 100H, 330L
3.2	350	5	20	34	175W, 110H, 380L
4.0	350	5	20	51	175W, 115H, 380L
5.0	350	5	20	78	175W, 115H, 380L

**Composition (all-weld metal mass%)**

	Typical (AC)	Guaranty <sup>a</sup>
<b>C</b>	0.03	0.04
<b>Si</b>	0.59	1.00
<b>Mn</b>	2.0	0.5~2.5
<b>P</b>	0.03	0.04
<b>S</b>	<0.01	0.03
<b>Ni</b>	13.1	11.0~14.0
<b>Cr</b>	18.0	17.0~20.0
<b>Mo</b>	2.2	2.0~3.0
<b>Cu</b>	0.05	0.75

**Welding parameters (A)**

φ mm	1F, 1G, 2F, 2G	3G uphill, 4G
2.6	50~85	45~80
3.2	70~115	65~110
4.0	95~145	85~130
5.0	135~180	-

Note: <sup>a</sup> Single values are maximum.

**All-weld mechanical properties**

	Typical (AC)	Guaranty
<b>0.2%YS (MPa)</b>	390	-
<b>TS (MPa)</b>	530	483min.
<b>EI on 4d (%)</b>	44	30min.
<b>IV -196°C (J)</b>	40	27min.

## Stick electrode

**Features:** • Suitable for low carbon 19%Cr-13%Ni-3%Mo steel

**Classification:** AWS A5.4 E317L-16

**Redrying Conditions:** 150~200°Cx 0.5~1h

**Identification color:** 1st Sorrel, 2nd Orange

**Polarity:** AC, DCEP

## Welding Positions:

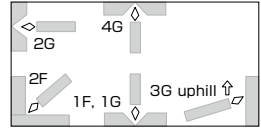

## Packaging data

φ mm	Length mm	kg/pack	kg/carton	g/piece	carton mm
2.6	300	2	20	19	300W, 100H, 330L
3.2	350	5	20	34	175W, 110H, 380L
4.0	350	5	20	51	175W, 115H, 380L
5.0	350	5	20	79	175W, 115H, 380L

## Composition (all-weld metal mass%)

	Typical (AC)	Guaranty <sup>a</sup>
<b>C</b>	0.03	0.04
<b>Si</b>	0.55	1.00
<b>Mn</b>	1.2	0.5~2.5
<b>P</b>	0.03	0.04
<b>S</b>	<0.01	0.03
<b>Ni</b>	13.3	12.0~14.0
<b>Cr</b>	19.7	18.0~21.0
<b>Mo</b>	3.7	3.0~4.0
<b>Cu</b>	0.05	0.75

Note: <sup>a</sup> Single values are maximum.

## Welding parameters (A)

φ mm	1F, 1G, 2F, 2G	3G uphill, 4G
2.6	50~85	45~80
3.2	70~115	65~110
4.0	95~145	85~135
5.0	135~180	-

## All-weld mechanical properties

	Typical (AC)	Guaranty
<b>0.2%YS (MPa)</b>	440	-
<b>TS (MPa)</b>	600	518min.
<b>El on 4d (%)</b>	39	30min.

## Stick electrode

**Features:** ▪ Suitable for 18%Cr-8%Ni-Nb steel

**Classification:** AWS A5.4 E347-16

**Redrying Conditions:** 150~200°Cx0.5~1h

**Identification color:** 1st Blue, 2nd Blue

**Polarity:** AC, DCEP

## Welding Positions:

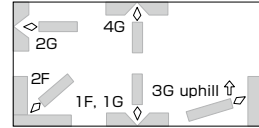

## Packaging data

φ mm	Length mm	kg/pack	kg/carton	g/piece	carton mm
2.6	250	2	20	15	300W, 100H, 280L
3.2	300	2	20	28	300W, 95H, 330L
4.0	350	5	20	50	175W, 120H, 380L
5.0	350	5	20	77	175W, 120H, 380L

## Composition (all-weld metal mass%)

	Typical (AC)	Guaranty <sup>a</sup>
<b>C</b>	0.06	0.08
<b>Si</b>	0.55	1.00
<b>Mn</b>	1.5	0.5~2.5
<b>P</b>	0.02	0.04
<b>S</b>	<0.01	0.03
<b>Ni</b>	10.1	9.0~11.0
<b>Cr</b>	19.6	18.0~21.0
<b>Mo</b>	0.04	0.75
<b>Cu</b>	0.04	0.75
<b>Nb+Ta</b>	0.67	8xC%~1.00

Note: <sup>a</sup>Single values are maximum.

## Welding parameters (A)

φ mm	1F, 1G, 2F, 2G	3G uphill, 4G
2.6	50~85	45~80
3.2	70~115	65~110
4.0	95~145	85~135
5.0	135~180	-

## All-weld mechanical properties

	Typical (AC)	Guaranty
<b>0.2%YS (MPa)</b>	470	-
<b>TS (MPa)</b>	670	518min.
<b>El on 4d (%)</b>	34	30min.



## Stick electrode

**Features:** • Suitable for 18%Cr-8%Ni-Nb steel

**Classification:** AWS A5.4 E347-16

**Redrying Conditions:** 150~200°Cx0.5~1h

**Identification color:** 1st Blue, 2nd Green

**Polarity:** AC, DCEP

## Welding Positions:

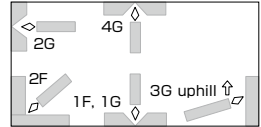

## Packaging data

φ mm	Length mm	kg/pack	kg/carton	g/piece	carton mm
2.6	300	2	20	18	300W, 100H, 330L
3.2	350	5	20	33	175W, 110H, 380L
4.0	350	5	20	51	175W, 115H, 380L
5.0	350	5	20	79	175W, 115H, 380L

## Composition (all-weld metal mass%)

	Typical (AC)	Guaranty <sup>a</sup>
<b>C</b>	0.04	0.08
<b>Si</b>	0.58	1.00
<b>Mn</b>	2.3	0.5~2.5
<b>P</b>	0.02	0.04
<b>S</b>	<0.01	0.03
<b>Ni</b>	9.7	9.0~11.0
<b>Cr</b>	19.1	18.0~21.0
<b>Nb</b>	0.59	8xC%~1.00

Note: <sup>a</sup> Single values are maximum.

## Welding parameters (A)

φ mm	1F, 1G, 2F, 2G	3G uphill, 4G
2.6	50~85	45~80
3.2	70~115	65~110
4.0	95~145	85~135
5.0	135~180	-

## All-weld mechanical properties

	Typical (AC)	Guaranty
<b>0.2%YS (MPa)</b>	420	-
<b>TS (MPa)</b>	600	518min.
<b>EI on 4d (%)</b>	45	30min.

## Stick electrode

- Features:**
- Suitable for 13%Cr stainless steels such as 403, 410 and 405 type.
  - Preheat: 100~250°C

## Welding Positions:

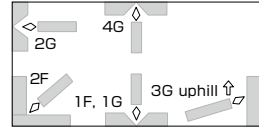

**Classification:** AWS A5.4 E409Nb-16

**Redrying Conditions:** 300~350°Cx0.5~1h

**Identification color:** 1st Purple, 2nd Orange

**Polarity:** AC, DCEP

## Packaging data

φ mm	Length mm	kg/pack	kg/carton	g/piece	carton mm
2.6	300	2	20	17	300W, 100H, 330L
3.2	350	5	20	31	175W, 120H, 380L
4.0	400	5	20	53	175W, 120H, 430L
5.0	400	5	20	82	175W, 120H, 430L

## Composition (all-weld metal mass%)

	Typical (AC)	Guaranty <sup>a</sup>
<b>C</b>	0.09	0.12
<b>Si</b>	0.40	1.00
<b>Mn</b>	0.3	1.0
<b>P</b>	0.02	0.04
<b>S</b>	<0.01	0.03
<b>Ni</b>	0.1	0.6
<b>Cr</b>	12.9	11.0~14.0
<b>Mo</b>	0.05	0.75
<b>Cu</b>	0.03	0.75
<b>Nb+Ta</b>	0.81	0.50~1.50

Note: <sup>a</sup>Single values are maximum.

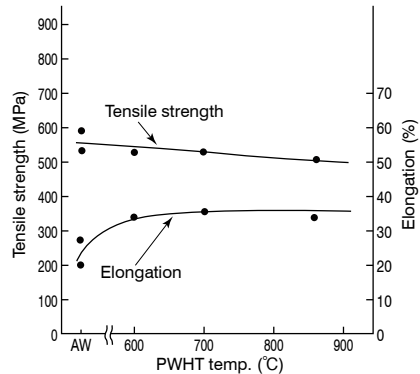

**Mechanical properties vs. PWHT temp.**

## All-weld mechanical properties

	Typical	Guaranty
<b>0.2%YS (MPa)</b>	270	-
<b>TS (MPa)</b>	500	450min.
<b>El on 4d (%)</b>	35	20min.
<b>PWHT (°Cxh)</b>	850x2	

## Welding parameters (A)

φ mm	1F, 1G, 2F, 2G	3G uphill, 4G
2.6	60~85	50~80
3.2	80~115	65~105
4.0	100~145	95~140
5.0	140~180	-

## Stick electrode

- Features:**
- Suitable for 13%Cr stainless steels such as 403 and 410 types.
  - Preheat: 200~400°C

**Classification:** AWS A5.4 E410-16

**Redrying Conditions:** 300~350°Cx0.5~1h

**Identification color:** 1st Purple

**Polarity:** AC, DCEP

## Welding Positions:

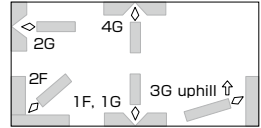

## Packaging data

φ mm	Length mm	kg/pack	kg/carton	g/piece	carton mm
2.6	300	2	20	18	300W, 100H, 330L
3.2	350	5	20	30	175W, 120H, 380L
4.0	400	5	20	54	175W, 120H, 430L
5.0	400	5	20	83	175W, 120H, 430L

## Composition (all-weld metal mass%)

	Typical (AC)	Guaranty <sup>a</sup>
<b>C</b>	0.06	0.12
<b>Si</b>	0.47	0.90
<b>Mn</b>	0.3	1.0
<b>P</b>	0.02	0.04
<b>S</b>	0.01	0.03
<b>Ni</b>	0.1	0.7
<b>Cr</b>	12.8	11.0~13.5
<b>Mo</b>	0.04	0.75
<b>Cu</b>	0.02	0.75

Note: <sup>a</sup> Single values are maximum.

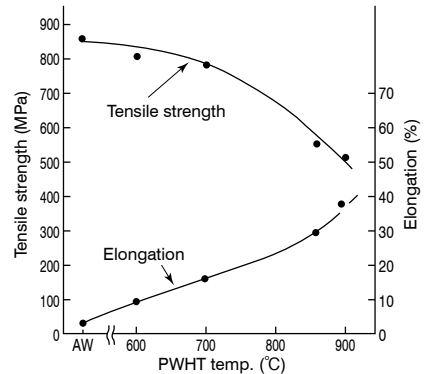

Mechanical properties vs. PWHT temp.

## All-weld mechanical properties

	Typical	Guaranty
<b>0.2%YS (MPa)</b>	290	-
<b>TS (MPa)</b>	510	450min.
<b>El on 4d (%)</b>	33	20min.
<b>PWHT (°Cxh)</b>	850x2	

## Welding parameters (A)

φ mm	1F, 1G, 2F, 2G	3G uphill, 4G
2.6	50~85	45~80
3.2	70~115	65~110
4.0	95~145	85~135
5.0	135~180	-

## Stick electrode

**Features:** ▪ Suitable for normal duplex stainless steel  
(S32205, S31803, etc.)

**Classification:** AWS A5.4 E2209-16

**Redrying Conditions:** 250~350°Cx1~2h

**Identification color:** -

**Polarity:** AC, DCEP

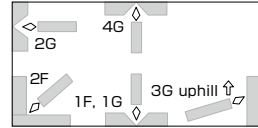
**Welding Positions:****Packaging data**

φ mm	Length mm	kg/pack	kg/carton	g/piece	carton mm
2.6	300	2	20	20	300W, 95H, 330L
3.2	350	5	20	35	175W, 135H, 380L
4.0	350	5	20	53	175W, 130H, 380L
5.0	350	5	20	79	175W, 130H, 380L

**Composition (all-weld metal mass%)**

	Typical (AC)	Guaranty <sup>a</sup>
<b>C</b>	0.03	0.04
<b>Si</b>	0.47	1.00
<b>Mn</b>	1.1	0.5~2.0
<b>P</b>	0.02	0.04
<b>S</b>	<0.01	0.03
<b>Ni</b>	9.0	8.5~10.5
<b>Cr</b>	23.2	21.5~23.5
<b>Mo</b>	3.2	2.5~3.5
<b>N</b>	0.17	0.08~0.20
<b>Cu</b>	0.05	0.75

Note: <sup>a</sup>Single values are maximum.

**Welding parameters (A)**

φ mm	1F, 1G, 2F, 2G	3G uphill, 4G
2.6	75~95	70~90
3.2	85~120	80~115
4.0	110~160	90~140
5.0	150~200	-

**All-weld mechanical properties**

	Typical (AC)	Guaranty
<b>0.2%YS (MPa)</b>	667	-
<b>TS (MPa)</b>	845	690min.
<b>El on 4d (%)</b>	30	20min.
<b>IV -50°C (J)</b>	72	-

## Stick electrode

**Features:** • Suitable for super duplex stainless steel (S32750, S32760, etc.)

## Welding Positions:

**Classification:** AWS A5.4 E2594-16

**Redrying Conditions:** 250~350°Cx1~2h

**Identification color:** -

**Polarity:** AC, DCEP

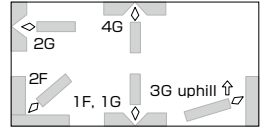

## Packaging data

φ mm	Length mm	kg/pack	kg/carton	g/piece	carton mm
2.6	300	2	20	20	300W, 95H, 330L
3.2	350	5	20	35	175W, 135H, 380L
4.0	350	5	20	53	175W, 130H, 380L
5.0	350	5	20	79	175W, 130H, 380L

## Composition (all-weld metal mass%)

	Typical (AC)	Guaranty <sup>a</sup>
<b>C</b>	0.03	0.04
<b>Si</b>	0.55	1.00
<b>Mn</b>	0.7	0.5~2.0
<b>P</b>	0.02	0.04
<b>S</b>	<0.01	0.03
<b>Ni</b>	9.3	8.0~10.5
<b>Cr</b>	25.4	24.0~27.0
<b>Mo</b>	3.9	3.5~4.5
<b>N</b>	0.24	0.20~0.30
<b>Cu</b>	0.05	0.75

Note: <sup>a</sup>Single values are maximum.

## Welding parameters (A)

φ mm	1F, 1G, 2F, 2G	3G uphill, 4G
2.6	75~95	70~90
3.2	85~120	80~115
4.0	110~160	90~140
5.0	150~200	-

## All-weld mechanical properties

	Typical (AC)	Guaranty
<b>0.2%YS (MPa)</b>	750	-
<b>TS (MPa)</b>	935	759min.
<b>El on 4d (%)</b>	28	15min.
<b>IV -50°C (J)</b>	40	-

## Approvals

DNV	MG
-----	----

## Stick electrode

- Features:**
- Suitable for urea plant in cryogenic temperature service
  - Lime titania type

## Welding Positions:

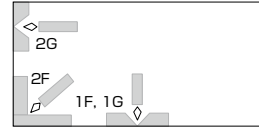

**Classification:** AWS -

**Redrying Conditions:** 150~200°Cx0.5~1h

**Identification color:** 1st Green, 2nd Pink

**Polarity:** AC, DCEP

## Packaging data

φ mm	Length mm	kg/pack	kg/carton	g/piece	carton mm
2.6	300	2	20	18	300W, 120H, 330L
3.2	300	5	20	29	300W, 110H, 330L
4.0	350	5	20	55	175W, 120H, 380L
5.0	350	5	20	83	175W, 120H, 380L

## Composition (all-weld metal mass%)

	Typical (AC)	Guaranty <sup>a</sup>
<b>C</b>	0.03	0.04
<b>Si</b>	0.31	0.90
<b>Mn</b>	5.09	4.00~7.00
<b>P</b>	0.013	0.030
<b>S</b>	0.002	0.020
<b>Ni</b>	17.06	15.00~18.00
<b>Cr</b>	17.97	17.00~19.50
<b>Mo</b>	2.80	2.20~3.00

## Welding parameters (A)

φ mm	1F, 1G, 2F, 2G
2.6	50~85
3.2	70~115
4.0	95~145
5.0	135~180

Note: <sup>a</sup> Single values are maximum.

## All-weld mechanical properties

	Typical (AC)	Guaranty
<b>0.2%YS (MPa)</b>	370	-
<b>TS (MPa)</b>	520	480min.
<b>EI on 4d (%)</b>	44	25min.
<b>IV -257°C (J)</b>	70	-

# DW-308H

## Flux cored wire

- Features:**
- Suitable for 18%Cr-8%Ni steel for high temperature service
  - Bi-free type

**Classification:** AWS A5.22 E308HT1-1/4

**Shielding gas:** CO<sub>2</sub> or Ar-CO<sub>2</sub>

**Polarity:** DCEP

## Welding Positions:

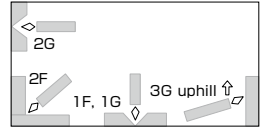

## Packaging data

φ mm	Spool
1.2	12.5kg
Volume mm	295W, 110H, 295L

## Composition (all-weld metal mass%)

	Typical (CO <sub>2</sub> )	Guaranty <sup>a</sup>
<b>C</b>	0.05	0.04~0.08
<b>Si</b>	0.5	1.0
<b>Mn</b>	1.2	0.5~2.5
<b>P</b>	0.02	0.04
<b>S</b>	<0.01	0.03
<b>Ni</b>	9.6	9.0~11.0
<b>Cr</b>	19.0	18.0~21.0
<b>Mo</b>	0.02	0.75
<b>Cu</b>	0.03	0.75
<b>Bi</b>	<0.0005	-

Note: <sup>a</sup>Single values are maximum.

## Welding parameters (A)

φ mm	1F, 1G, 2F	2G	3G uphill
1.2	130~270	150~220	130~180

## All-weld mechanical properties

	Typical (CO <sub>2</sub> )	Guaranty
<b>0.2%YS (MPa)</b>	370	-
<b>TS (MPa)</b>	560	552min.
<b>El on 4d (%)</b>	48	30min.
<b>IV 0°C (J)</b>	71	-

## Approvals

CWB	E308HT1-1, E308HT1-4
-----	----------------------

# DW-308L

## Flux cored wire

**Features:** - Applied for 304L type steel

**Classification:** AWS A5.22 E308LT0-1/4

**Shielding gas:** CO<sub>2</sub> or Ar-CO<sub>2</sub>

**Polarity:** DCEP

## Welding Positions:

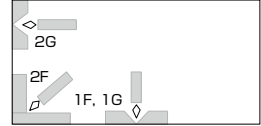

## Packaging data

φ mm	Spool	
0.9	5kg	12.5kg
1.2	-	12.5kg
1.6	-	12.5kg
<b>Volume mm</b>	235W, 110H, 230L	295W, 110H, 295L

## Composition (all-weld metal mass%)

	Typical (CO <sub>2</sub> )	Guaranty <sup>a</sup>
<b>C</b>	0.03	0.04
<b>Si</b>	0.6	1.0
<b>Mn</b>	1.5	0.5~2.5
<b>P</b>	0.02	0.04
<b>S</b>	<0.01	0.03
<b>Ni</b>	10.0	9.0~11.0
<b>Cr</b>	19.5	18.0~21.0
<b>Mo</b>	0.02	0.75
<b>Cu</b>	0.03	0.75
<b>Bi</b>	>0.002	-

Note: <sup>a</sup> Single values are maximum.

## Welding parameters (A)

φ mm	1F, 1G, 2F	2G
0.9	80~150	90~130
1.2	130~270	150~220
1.6	190~320	220~270

## All-weld mechanical properties

	Typical (CO <sub>2</sub> )	Guaranty
<b>0.2%YS (MPa)</b>	370	-
<b>TS (MPa)</b>	550	518min.
<b>EI on 4d (%)</b>	42	30min.
<b>IV 0°C (J)</b>	41	-

## Approvals

<b>ABS</b>	MG
<b>LR</b>	304L S (CHEM & CRYO)
<b>DNV</b>	VL308L, MG (CO <sub>2</sub> ) VL308L (Ar-CO <sub>2</sub> )
<b>NK</b>	KW308LG (C)
<b>CWB</b>	E308LT0-1, E308LT0-4

Note: CO<sub>2</sub>, except in CWB/DNV



## Flux cored wire

**Features:** ▪ Suitable for 18%Cr-8%Ni steel for low temperature service

## Welding Positions:

**Classification:** AWS A5.22 E308LT0-1/4

**Shielding gas:** CO<sub>2</sub> or Ar-CO<sub>2</sub>

**Polarity:** DCEP

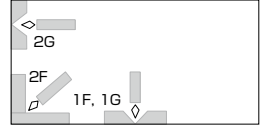

## Packaging data

φ mm	Spool
1.2	12.5kg
<b>Volume mm</b>	295W, 110H, 295L

## Composition (all-weld metal mass%)

	Typical (CO <sub>2</sub> )	Guaranty <sup>a</sup>
<b>C</b>	0.03	0.04
<b>Si</b>	0.3	1.0
<b>Mn</b>	2.2	0.5~2.5
<b>P</b>	0.02	0.04
<b>S</b>	0.01	0.03
<b>Ni</b>	10.3	9.0~11.0
<b>Cr</b>	18.6	18.0~21.0
<b>Mo</b>	0.01	0.75
<b>Cu</b>	0.05	0.75
<b>Bi</b>	>0.002	-

## Welding parameters (A)

φ mm	1F, 1G, 2F	2G
1.2	130~270	150~220

Note: <sup>a</sup>Single values are maximum.

## All-weld mechanical properties

	Typical (CO <sub>2</sub> )	Guaranty
<b>0.2%YS (MPa)</b>	380	-
<b>TS (MPa)</b>	530	518min.
<b>El on 4d (%)</b>	51	30min.
<b>IV -196°C (J)</b>	39	27min.

## Flux cored wire

- Features:**
- Suitable for 18%Cr-8%Ni steel with high temperature heat treatment such as solution treatment
  - Bi-free type

**Classification:** AWS A5.22 E308LT1-1/4

**Shielding gas:** CO<sub>2</sub> or Ar-CO<sub>2</sub>

**Polarity:** DCEP

## Welding Positions:

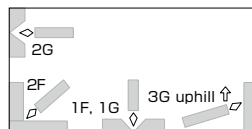

## Packaging data

φ mm	Spool
1.2	12.5kg
Volume mm	295W, 110H, 295L

## Composition (all-weld metal mass%)

	Typical (CO <sub>2</sub> )	Guaranty <sup>a</sup>
<b>C</b>	0.03	0.04
<b>Si</b>	0.4	1.0
<b>Mn</b>	1.3	0.5~2.5
<b>P</b>	0.02	0.04
<b>S</b>	<0.01	0.03
<b>Ni</b>	10.2	9.0~11.0
<b>Cr</b>	18.7	18.0~21.0
<b>Mo</b>	0.02	0.75
<b>Cu</b>	0.02	0.75
<b>Bi</b>	<0.0005	-

Note: <sup>a</sup> Single values are maximum.

## Welding parameters (A)

φ mm	1F, 1G, 2F	2G	3G uphill
1.2	130~270	150~220	130~180

## All-weld mechanical properties

	Typical (CO <sub>2</sub> )	Guaranty
<b>0.2%YS (MPa)</b>	360	-
<b>TS (MPa)</b>	540	518min.
<b>EI on 4d (%)</b>	52	30min.
<b>IV 0°C (J)</b>	76	-

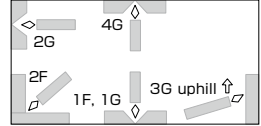
**Flux cored wire****Features:** • Applicable for 304 and 304L type steel**Classification:** AWS A5.22 E308LT1-1/4**Shielding gas:** CO<sub>2</sub> or Ar-CO<sub>2</sub>**Polarity:** DCEP**Welding Positions:****Packaging data**

$\phi$ mm	Spool
1.2	12.5kg
<b>Volume mm</b>	295W, 110H, 295L

**Composition (all-weld metal mass%)**

	Typical (CO <sub>2</sub> )	Guaranty <sup>a</sup>
<b>C</b>	0.02	0.04
<b>Si</b>	0.8	1.0
<b>Mn</b>	1.1	0.5~2.5
<b>P</b>	0.02	0.04
<b>S</b>	<0.01	0.03
<b>Ni</b>	9.9	9.0~11.0
<b>Cr</b>	20.3	18.0~21.0
<b>Mo</b>	0.02	0.75
<b>Cu</b>	0.03	0.75
<b>Bi</b>	>0.002	-

Note: <sup>a</sup>Single values are maximum.**All-weld mechanical properties**

	Typical (CO <sub>2</sub> )	Guaranty
<b>0.2%YS (MPa)</b>	380	-
<b>TS (MPa)</b>	550	518min.
<b>EI on 4d (%)</b>	45	30min.
<b>IV 0°C (J)</b>	57	-

**Approvals**

<b>ABS</b>	MG (AWS A5.22 E308LT1-1)
<b>LR</b>	304L S (CHEM & CRYO)
<b>DNV</b>	VL308L, MG
<b>BV</b>	308L BT
<b>NK</b>	KW308LG (C)
<b>KR</b>	RW308LG (C)
<b>CWB</b>	E308LT1-1, E308LT1-4

Note: CO<sub>2</sub>, except in CWB**Welding parameters (A)**

$\phi$ mm	1F, 1G, 2F	2G	3G uphill	4G
1.2	130~270	150~220	130~220	150~200

## Flux cored wire

**Features:** - Applicable for 304 type steel

**Classification:** AWS A5.22 E308T0-1/4

**Shielding gas:** CO<sub>2</sub> or Ar-CO<sub>2</sub>

**Polarity:** DCEP

## Welding Positions:

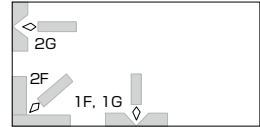

## Packaging data

φ mm	Spool	
0.9	5kg	12.5kg
1.2	-	12.5kg
1.6	-	12.5kg
<b>Volume mm</b>	235W, 110H, 230L	295W, 110H, 295L

## Composition (all-weld metal mass%)

	Typical (CO <sub>2</sub> )	Guaranty <sup>a</sup>
<b>C</b>	0.05	0.08
<b>Si</b>	0.6	1.0
<b>Mn</b>	1.5	0.5~2.5
<b>P</b>	0.02	0.04
<b>S</b>	0.01	0.03
<b>Ni</b>	9.7	9.0~11.0
<b>Cr</b>	19.7	18.0~21.0
<b>Mo</b>	0.02	0.75
<b>Cu</b>	0.03	0.75
<b>Bi</b>	>0.002	-

Note: <sup>a</sup> Single values are maximum.

## Welding parameters (A)

φ mm	1F, 1G, 2F	2G
0.9	80~150	90~130
1.2	130~270	150~220
1.6	190~320	220~270

## All-weld mechanical properties

	Typical (CO <sub>2</sub> )	Guaranty
<b>0.2%YS (MPa)</b>	390	-
<b>TS (MPa)</b>	570	552min.
<b>EI on 4d (%)</b>	41	30min.
<b>IV 0°C (J)</b>	39	-

## Approvals

<b>ABS</b>	MG (A5.22 E308T0-1) KW308G (C)
<b>NK</b>	

Note: CO<sub>2</sub>

# DW-308L-XR

## Flux cored wire

- Features:**
- Applied for 304L type stainless steel
  - Low Cr (VI) stainless steel flux cored wire

**Classification:** AWS A5.22 E308LT0-1/4

**Shielding gas:** CO<sub>2</sub> or Ar-CO<sub>2</sub>

**Polarity:** DCEP

### Welding Positions:

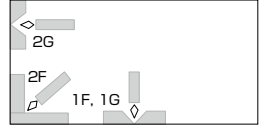

### Packaging data

φ mm	Spool
1.2	12.5kg
Volume mm	295W, 110H, 295L

### Composition (wire mass%)

	Typical (Ar-CO <sub>2</sub> )	Guaranty <sup>a</sup>
<b>C</b>	0.03	0.04
<b>Si</b>	0.7	1.0
<b>Mn</b>	1.3	0.5~2.5
<b>P</b>	0.02	0.04
<b>S</b>	<0.01	0.03
<b>Ni</b>	9.5	9.0~11.0
<b>Cr</b>	19.4	18.0~21.0
<b>Mo</b>	0.01	0.75
<b>Cu</b>	0.02	0.75

Note: <sup>a</sup> Single values are maximum.

### Welding parameters (A)

φ mm	1F, 1G, 2F	2G
1.2	130~270	150~220

### All-weld mechanical properties

	Typical (Ar-CO <sub>2</sub> )	Guaranty
<b>0.2%YS (MPa)</b>	396	-
<b>TS (MPa)</b>	583	518min.
<b>EI on 4d (%)</b>	42	30min.

### Approvals

CWB	E308LT0-1, E308LT0-4
-----	----------------------

# DW-308LP-XR

# PREMIARC™

## Flux cored wire

- Features:**
- Applied for 304L type stainless steel
  - Low Cr (VI) stainless steel flux cored wire

**Classification:** AWS A5.22 E308LT1-1/4

**Shielding gas:** CO<sub>2</sub> or Ar-CO<sub>2</sub>

**Polarity:** DCEP

## Welding Positions:

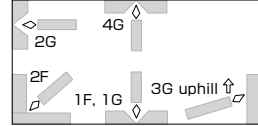

## Packaging data

φ mm	Spool
1.2	12.5kg
<b>Volume mm</b>	295W, 110H, 295L

## Composition (wire mass%)

	Typical (Ar-CO <sub>2</sub> )	Guaranty <sup>a</sup>
<b>C</b>	0.03	0.04
<b>Si</b>	0.8	1.0
<b>Mn</b>	1.8	0.5~2.5
<b>P</b>	0.02	0.04
<b>S</b>	<0.01	0.03
<b>Ni</b>	10.4	9.0~11.0
<b>Cr</b>	19.5	18.0~21.0
<b>Mo</b>	0.02	0.75
<b>Cu</b>	0.04	0.75

Note: <sup>a</sup>Single values are maximum.

## All-weld mechanical properties

	Typical (Ar-CO <sub>2</sub> )	Guaranty
<b>0.2%YS (MPa)</b>	386	-
<b>TS (MPa)</b>	551	518min.
<b>EI on 4d (%)</b>	42	30min.

## Approvals

<b>ABS*</b>	MG (AWS A5.22 E308LT1-4)
<b>CWB</b>	E308LT1-1, E308LT1-4

Note: \*Ar-25%CO<sub>2</sub>

## Welding parameters (A)

φ mm	1F, 1G, 2F	2G	3G uphill	4G
1.2	130~270	150~220	130~220	150~200

# DW-309MoL

## Flux cored wire

**Features:** • Suitable for dissimilar-metal joint and underlaying on ferritic steels

**Classification:** AWS A5.22 E309LMoT0-1/4

**Shielding gas:** CO<sub>2</sub> or Ar-CO<sub>2</sub>

**Polarity:** DCEP

### Welding Positions:

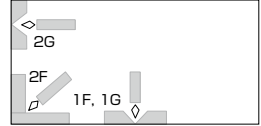

### Packaging data

φ mm	Spool
1.2	12.5kg
1.6	12.5kg
<b>Volume mm</b>	295W, 110H, 295L

### Composition (all-weld metal mass%)

	Typical (CO <sub>2</sub> )	Guaranty <sup>a</sup>
<b>C</b>	0.03	0.04
<b>Si</b>	0.7	1.0
<b>Mn</b>	1.4	0.5~2.5
<b>P</b>	0.02	0.04
<b>S</b>	<0.01	0.03
<b>Ni</b>	12.3	12.0~16.0
<b>Cr</b>	23.2	21.0~25.0
<b>Mo</b>	2.4	2.0~3.0
<b>Cu</b>	0.07	0.75
<b>Bi</b>	>0.002	-

Note: <sup>a</sup> Single values are maximum.

### Welding parameters (A)

φ mm	1F, 1G, 2F	2G
1.2	130~270	150~220
1.6	190~320	220~270

### All-weld mechanical properties

	Typical (CO <sub>2</sub> )	Guaranty
<b>0.2%YS (MPa)</b>	540	-
<b>TS (MPa)</b>	720	518min.
<b>EI on 4d (%)</b>	30	25min.

### Approvals

<b>ABS</b>	MG
<b>LR</b>	SS/CMn S (CHEM)
<b>DNV</b>	VL309MoL (CO <sub>2</sub> /Ar-CO <sub>2</sub> )
<b>BV</b>	UP
<b>NK</b>	KW309MoLG (C) KW309MoLG (C)-YP315M-TS550M

Note: CO<sub>2</sub>, except in DNV

## Flux cored wire

**Features:** • Suitable for dissimilar-metal joint and underlaying on ferritic steels

**Classification:** AWS A5.22 E309LMoT1-1/4

**Shielding gas:** CO<sub>2</sub> or Ar-CO<sub>2</sub>

**Polarity:** DCEP

## Welding Positions:

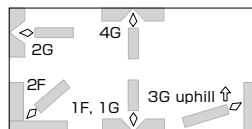

## Packaging data

φ mm	Spool
1.2	12.5kg
<b>Volume mm</b>	295W, 110H, 295L

## Composition (all-weld metal mass%)

	Typical (CO <sub>2</sub> )	Guaranty <sup>a</sup>
<b>C</b>	0.03	0.04
<b>Si</b>	0.4	1.0
<b>Mn</b>	0.6	0.5~2.5
<b>P</b>	0.02	0.04
<b>S</b>	<0.01	0.03
<b>Ni</b>	12.4	12.0~16.0
<b>Cr</b>	22.3	21.0~25.0
<b>Mo</b>	2.3	2.0~3.0
<b>Cu</b>	0.04	0.75
<b>Bi</b>	>0.002	-

Note: <sup>a</sup>Single values are maximum.

## All-weld mechanical properties

	Typical (CO <sub>2</sub> )	Guaranty
<b>0.2%YS (MPa)</b>	540	-
<b>TS (MPa)</b>	699	518min.
<b>EI on 4d (%)</b>	30	25min.

## Approvals

<b>NK</b>	KW309MoLG (C), KW309MoLG (C)- YP315M-TS550M
-----------	--

Note: CO<sub>2</sub>

## Welding parameters (A)

φ mm	1F, 1G, 2F	2G	3G uphill	4G
1.2	130~270	150~220	130~220	150~200



**Flux cored wire**

**Features:**     ▪ Suitable for dissimilar-metal joint and underlaying on ferritic steels

**Classification:** AWS A5.22 E309LT0-1/4

**Shielding gas:** CO<sub>2</sub> or Ar-CO<sub>2</sub>

**Polarity:**       DCEP

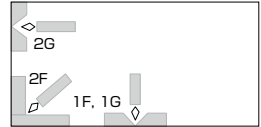
**Welding Positions:****Packaging data**

φ mm	Spool		Drum	
	5kg	12.5kg	-	-
0.9	5kg	12.5kg	-	-
1.2	-	12.5kg	150kg	-
1.6	-	12.5kg	-	200kg
<b>Volume mm</b>	235W, 110H, 230L	295W, 110H, 295L	530 φ, 820H	680 φ, 770H

**Composition (all-weld metal mass%)**

	Typical (CO <sub>2</sub> )	Guaranty <sup>a</sup>
<b>C</b>	0.03	0.04
<b>Si</b>	0.6	1.0
<b>Mn</b>	1.2	0.5~2.5
<b>P</b>	0.02	0.04
<b>S</b>	<0.01	0.03
<b>Ni</b>	12.4	12.0~14.0
<b>Cr</b>	23.8	22.0~25.0
<b>Mo</b>	0.03	0.75
<b>Cu</b>	0.02	0.75
<b>Bi</b>	>0.002	-

Note: <sup>a</sup> Single values are maximum.

**Welding parameters (A)**

φ mm	1F, 1G, 2F	2G
0.9	80~150	90~130
1.2	130~270	150~220
1.6	190~320	220~270

**All-weld mechanical properties**

	Typical (CO <sub>2</sub> )	Guaranty
<b>0.2%YS (MPa)</b>	450	-
<b>TS (MPa)</b>	580	518min.
<b>El on 4d (%)</b>	33	30min.

**Approvals**

<b>ABS</b>	MG
<b>LR</b>	SS/CMn S (CHEM) (CO <sub>2</sub> ) SS/CMn S (CHEM), Dup/CMnS (CHEM) (Ar-CO <sub>2</sub> )
<b>DNV</b>	VL309L
<b>BV</b>	UP
<b>NK</b>	KW309LG (C)
<b>CWB</b>	E309LT0-1, E309LT0-4

Note: CO<sub>2</sub>, except in LR/CWB

## Flux cored wire

- Features:**
- Suitable for dissimilar metal joint of solution heat treatment and underlaying on ferritic steels for overlaying stainless steel weld metals
  - Bi-free type

## Welding Positions:

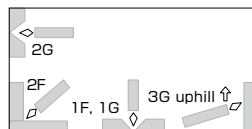

**Classification:** AWS A5.22 E309LT1-1/4

**Shielding gas:** CO<sub>2</sub> or Ar-CO<sub>2</sub>

**Polarity:** DCEP

## Packaging data

φ mm	Spool
1.2	12.5kg
<b>Volume mm</b>	295W, 110H, 295L

## Composition (all-weld metal mass%)

	Typical (CO <sub>2</sub> )	Guaranty <sup>a</sup>
<b>C</b>	0.03	0.04
<b>Si</b>	0.4	1.0
<b>Mn</b>	1.2	0.5~2.5
<b>P</b>	0.02	0.04
<b>S</b>	<0.01	0.03
<b>Ni</b>	12.6	12.0~14.0
<b>Cr</b>	23.1	22.0~25.0
<b>Mo</b>	0.02	0.75
<b>Cu</b>	0.02	0.75
<b>Bi</b>	<0.0005	-

Note: <sup>a</sup> Single values are maximum.

## Welding parameters (A)

φ mm	1F, 1G, 2F	2G	3G uphill
1.2	130~270	150~220	130~180

## All-weld mechanical properties

	Typical (CO <sub>2</sub> )	Guaranty
<b>0.2%YS (MPa)</b>	380	-
<b>TS (MPa)</b>	590	518min.
<b>EI on 4d (%)</b>	36	30min.

**DW-309LP****Flux cored wire**

**Features:**     ▪ Suitable for dissimilar-metal joint and underlaying on ferritic steels

**Classification:** AWS A5.22 E309LT1-1/4

**Shielding gas:** CO<sub>2</sub> or Ar-CO<sub>2</sub>

**Polarity:**       DCEP

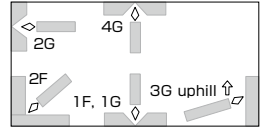
**Welding Positions:****Packaging data**

$\phi$ mm	Spool
1.2	12.5kg
<b>Volume mm</b>	295W, 110H, 295L

**Composition (all-weld metal mass%)**

	Typical (CO <sub>2</sub> )	Guaranty <sup>a</sup>
<b>C</b>	0.02	0.04
<b>Si</b>	0.8	1.0
<b>Mn</b>	0.8	0.5~2.5
<b>P</b>	0.02	0.04
<b>S</b>	<0.01	0.03
<b>Ni</b>	12.4	12.0~14.0
<b>Cr</b>	23.2	22.0~25.0
<b>Mo</b>	0.02	0.75
<b>Cu</b>	0.02	0.75
<b>Bi</b>	>0.002	-

Note: <sup>a</sup> Single values are maximum.

**All-weld mechanical properties**

	Typical (CO <sub>2</sub> )	Guaranty
<b>0.2%YS (MPa)</b>	430	-
<b>TS (MPa)</b>	570	518min.
<b>EI on 4d (%)</b>	38	30min.

**Approvals**

	CO <sub>2</sub>	Ar-CO <sub>2</sub>
<b>ABS</b>	MG (AWS A5.22 E309LT1-1) SS/CMn S (CHEM & CRYO), Dup/CMnS (CHEM)	MG (AWS A5.22 E309LT1-4)
<b>LR</b>		SS/CMn S (CHEM)
<b>DNV</b>	VL309L	VL309L
<b>BV</b>	309L, UP	-
<b>NK</b>	KW309LG (C)	-
<b>KR</b>	RW309LG (C)	-
<b>CCS</b>	309L, UP	-
<b>CWB</b>	E309LT1-1	E309LT1-4

**Welding parameters (A)**

$\phi$ mm	1F, 1G, 2F	2G	3G uphill	4G
1.2	130~270	150~220	130~220	150~200

## Flux cored wire

**Features:** • Suitable for dissimilar-metal joint and underlaying on ferritic steels

**Classification:** AWS A5.22 E309T0-1/4

**Shielding gas:** CO<sub>2</sub> or Ar-CO<sub>2</sub>

**Polarity:** DCEP

## Welding Positions:

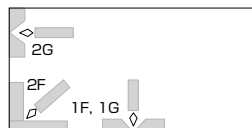

## Packaging data

φ mm	Spool	Drum
1.2	12.5kg	200kg
1.6	12.5kg	-
<b>Volume mm</b>	295W, 110H, 295L	680 φ , 770H

## Composition (all-weld metal mass%)

	Typical (CO <sub>2</sub> )	Guaranty <sup>a</sup>
<b>C</b>	0.03	0.10
<b>Si</b>	0.7	1.0
<b>Mn</b>	1.2	0.5~2.5
<b>P</b>	0.02	0.04
<b>S</b>	<0.01	0.03
<b>Ni</b>	12.3	12.0~14.0
<b>Cr</b>	24.0	22.0~25.0
<b>Mo</b>	0.02	0.75
<b>Cu</b>	0.03	0.75
<b>Bi</b>	>0.002	-

Note: <sup>a</sup>Single values are maximum.

## Welding parameters (A)

φ mm	1F, 1G, 2F	2G
1.2	130~270	150~220
1.6	190~320	220~270

## All-weld mechanical properties

	Typical (CO <sub>2</sub> )	Guaranty
<b>0.2%YS (MPa)</b>	450	-
<b>TS (MPa)</b>	590	552min.
<b>EI on 4d (%)</b>	32	30min.
<b>IV 0°C (J)</b>	33	-

## Approvals

LR	SS/CMn S (CHEM)
----	-----------------

Note: CO<sub>2</sub>

# DW-309L-XR

## Flux cored wire

- Features:**
- Suitable for dissimilar-metal joint and underlaying on ferritic steels
  - Low Cr (VI) stainless steel flux cored wire

## Welding Positions:

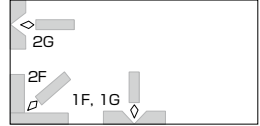

**Classification:** AWS A5.22 E309LT0-1/4

**Shielding gas:** CO<sub>2</sub> or Ar-CO<sub>2</sub>

**Polarity:** DCEP

## Packaging data

φ mm	Spool
1.2	12.5kg
<b>Volume mm</b>	295W, 110H, 295L

## Composition (wire mass%)

	Typical (Ar-CO <sub>2</sub> )	Guaranty <sup>a</sup>
<b>C</b>	0.03	0.04
<b>Si</b>	0.8	1.0
<b>Mn</b>	1.1	0.5~2.5
<b>P</b>	0.02	0.04
<b>S</b>	<0.01	0.03
<b>Ni</b>	12.4	12.0~14.0
<b>Cr</b>	24.1	22.0~25.0
<b>Mo</b>	0.03	0.75
<b>Cu</b>	0.03	0.75

Note: <sup>a</sup>Single values are maximum.

## Welding parameters (A)

φ mm	1F, 1G, 2F	2G
1.2	130~270	150~220

## All-weld mechanical properties

	Typical (Ar-CO <sub>2</sub> )	Guaranty
<b>0.2%YS (MPa)</b>	454	-
<b>TS (MPa)</b>	608	518min.
<b>EI on 4d (%)</b>	32	30min.

## Approvals

CWB	E309LT0-1, E309LT0-4
-----	----------------------

## Flux cored wire

- Features:**
- Suitable for dissimilar-metal joint and underlaying on ferritic steels
  - Low Cr (VI) stainless steel flux cored wire

## Welding Positions:

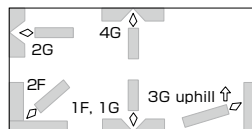

**Classification:** AWS A5.22 E309LT1-1/4

**Shielding gas:** CO<sub>2</sub> or Ar-CO<sub>2</sub>

**Polarity:** DCEP

## Packaging data

φ mm	Spool
1.2	12.5kg
<b>Volume mm</b>	295W, 110H, 295L

## Composition (wire mass%)

	Typical (Ar-CO <sub>2</sub> )	Guaranty <sup>a</sup>
<b>C</b>	0.03	0.04
<b>Si</b>	0.7	1.0
<b>Mn</b>	1.0	0.5~2.5
<b>P</b>	0.01	0.04
<b>S</b>	<0.01	0.03
<b>Ni</b>	12.3	12.0~14.0
<b>Cr</b>	24.2	22.0~25.0
<b>Mo</b>	0.02	0.75
<b>Cu</b>	0.01	0.75

Note: <sup>a</sup>Single values are maximum.

## All-weld mechanical properties

	Typical (Ar-CO <sub>2</sub> )	Guaranty
<b>0.2%YS (MPa)</b>	430	-
<b>TS (MPa)</b>	562	518min.
<b>EI on 4d (%)</b>	37	30min.

## Approvals

<b>ABS*</b>	MG (AWS A5.22 E309LT1-4)
<b>CWB</b>	E309LT1-1, E309LT1-4

Note: \*Ar-25%CO<sub>2</sub>

## Welding parameters (A)

φ mm	1F, 1G, 2F	2G	3G uphill	4G
1.2	130~270	150~220	130~220	150~200

## Flux cored wire

**Features:**      ▪ Suitable for 25%Cr-20%Ni steel

**Classification:** AWS A5.22 E310T0-1/4

**Shielding gas:** CO<sub>2</sub> or Ar-CO<sub>2</sub>

**Polarity:**        DCEP

## Welding Positions:

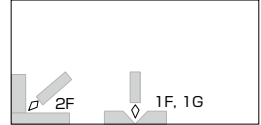

## Packaging data

φ mm	Spool
1.2	12.5kg
<b>Volume mm</b>	295W, 110H, 295L

## Composition (all-weld metal mass%)

	Typical (CO <sub>2</sub> )	Guaranty <sup>a</sup>
<b>C</b>	0.18	0.20
<b>Si</b>	0.4	1.0
<b>Mn</b>	2.0	1.0~2.5
<b>P</b>	0.02	0.03
<b>S</b>	<0.01	0.03
<b>Ni</b>	20.6	20.0~22.5
<b>Cr</b>	25.3	25.0~28.0
<b>Mo</b>	0.03	0.75
<b>Cu</b>	0.03	0.75

Note: <sup>a</sup> Single values are maximum.

## Welding parameters (A)

φ mm	1F, 1G, 2F
1.2	130~220

## All-weld mechanical properties

	Typical (CO <sub>2</sub> )	Guaranty
<b>0.2%YS (MPa)</b>	420	-
<b>TS (MPa)</b>	620	552min.
<b>El on 4d (%)</b>	33	30min.
<b>IV 0°C (J)</b>	68	-

## Approvals

CWB	E310T0-1, E310T0-4

## Flux cored wire

**Features:** • Suitable for dissimilar-metal joint and underlaying on ferritic steels for overlaying stainless steel weld metals

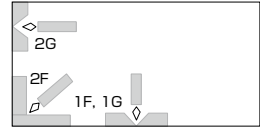
**Welding Positions:**

**Classification:** AWS A5.22 E312T0-1

**Shielding gas:** CO<sub>2</sub>

**Polarity:** DCEP

## Packaging data

φ mm	Spool
1.2	12.5kg
<b>Volume mm</b>	295W, 110H, 295L

## Composition (all-weld metal mass%)

	Typical	Guaranty <sup>a</sup>
<b>C</b>	0.11	0.15
<b>Si</b>	0.5	1.0
<b>Mn</b>	1.6	0.5~2.5
<b>P</b>	0.02	0.04
<b>S</b>	0.01	0.03
<b>Ni</b>	10.2	8.0~10.5
<b>Cr</b>	28.4	28.0~32.0
<b>Mo</b>	0.02	0.75
<b>Cu</b>	0.02	0.75
<b>Bi</b>	>0.002	-

Note: <sup>a</sup>Single values are maximum.

## Welding parameters (A)

φ mm	1F, 1G, 2F	2G
1.2	130~270	150~220

## All-weld mechanical properties

	Typical	Guaranty
<b>0.2%YS (MPa)</b>	600	-
<b>TS (MPa)</b>	720	655min.
<b>EI on 4d (%)</b>	23	22min.

## Approvals

CWB	E312T0-1
-----	----------

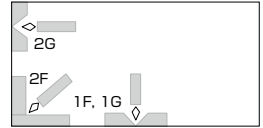

**DW-316L****Flux cored wire****Features:** • Applicable for 316L type steel**Classification:** AWS A5.22 E316LT0-1/4**Shielding gas:** CO<sub>2</sub> or Ar-CO<sub>2</sub>**Polarity:** DCEP**Welding Positions:****Packaging data**

φ mm	Spool		Drum
0.9	5kg	12.5kg	-
1.2	-	12.5kg	150kg
1.6	-	12.5kg	-
<b>Volume mm</b>	235W, 110H, 230L	295W, 110H, 295L	530 φ, 820H

**Composition (all-weld metal mass%)**

	Typical (CO <sub>2</sub> )	Guaranty <sup>a</sup>
<b>C</b>	0.02	0.04
<b>Si</b>	0.6	1.0
<b>Mn</b>	1.3	0.5~2.5
<b>P</b>	0.02	0.04
<b>S</b>	0.01	0.03
<b>Ni</b>	12.0	11.0~14.0
<b>Cr</b>	18.9	17.0~20.0
<b>Mo</b>	2.5	2.0~3.0
<b>Cu</b>	0.06	0.75
<b>Bi</b>	>0.002	-

Note: <sup>a</sup> Single values are maximum.**Welding parameters (A)**

φ mm	1F, 1G, 2F	2G
0.9	80~150	90~130
1.2	130~270	150~220
1.6	190~320	220~270

**All-weld mechanical properties**

	Typical (CO <sub>2</sub> )	Guaranty
<b>0.2%YS (MPa)</b>	380	-
<b>TS (MPa)</b>	540	483min.
<b>El on 4d (%)</b>	41	30min.
<b>IV 0°C (J)</b>	44	-

**Approvals**

	CO <sub>2</sub>	Ar-CO <sub>2</sub>
<b>ABS</b>	MG	-
<b>LR</b>	316L S (CHEM)	
<b>DNV</b>	VL316L	
<b>BV</b>	UP	-
<b>NK</b>	KW316LG (C)	-
<b>CWB</b>	E316LT0-1	E316LT0-4

# DW-316LT

**PREMIARC™****Flux cored wire**

**Features:** • Suitable for 18%Cr-12%Ni-2%Mo steel for low temperature service

**Classification:** AWS A5.22 E316LT1-1/4

**Shielding gas:** CO<sub>2</sub> or Ar-CO<sub>2</sub>

**Polarity:** DCEP

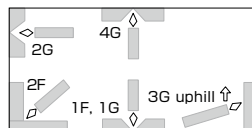
**Welding Positions:****Packaging data**

φ mm	Spool
1.2	12.5kg
<b>Volume mm</b>	295W, 110H, 295L

**Composition (all-weld metal mass%)**

	Typical (CO <sub>2</sub> )	Guaranty <sup>a</sup>
<b>C</b>	0.02	0.04
<b>Si</b>	0.4	1.0
<b>Mn</b>	1.2	0.5~2.5
<b>P</b>	0.02	0.04
<b>S</b>	<0.01	0.03
<b>Ni</b>	12.0	11.0~14.0
<b>Cr</b>	17.4	17.0~20.0
<b>Mo</b>	2.2	2.0~3.0
<b>Cu</b>	0.06	0.75

Note: <sup>a</sup>Single values are maximum.

**All-weld mechanical properties**

	Typical (CO <sub>2</sub> )	Guaranty
<b>0.2%YS (MPa)</b>	398	-
<b>TS (MPa)</b>	528	483min.
<b>EI on 4d (%)</b>	44	30min.
<b>IV -196°C (J)</b>	36	27min.

**Approvals**

<b>ABS</b>	MG (AWS A5.22 E316LT1-1)
<b>LR</b>	316LS (CHEM & CRYO)
<b>DNV</b>	VL316L, MG
<b>BV</b>	316LBT
<b>NK</b>	KW316LG (C)
<b>KR</b>	RW316LG (C)

Note: CO<sub>2</sub>

**Welding parameters (A)**

φ mm	1F, 1G, 2F	2G	3G uphill	4G
1.2	130~220	150~220	130~180	160~200

## Flux cored wire

- Features:**
- Suitable for 18%Cr-12%Ni-2%Mo steel with high temperature heat treatment such as solution treatment
  - Bi-free type

## Welding Positions:



**Classification:** AWS A5.22 E316LT1-1/4

**Shielding gas:** CO<sub>2</sub> or Ar-CO<sub>2</sub>

**Polarity:** DCEP

## Packaging data

φ mm	Spool
1.2	12.5kg
<b>Volume mm</b>	295W, 110H, 295L

## Composition (all-weld metal mass%)

	Typical (CO <sub>2</sub> )	Guaranty <sup>a</sup>
<b>C</b>	0.02	0.04
<b>Si</b>	0.4	1.0
<b>Mn</b>	1.1	0.5~2.5
<b>P</b>	0.02	0.04
<b>S</b>	<0.01	0.03
<b>Ni</b>	11.9	11.0~14.0
<b>Cr</b>	18.5	17.0~20.0
<b>Mo</b>	2.4	2.0~3.0
<b>Cu</b>	0.02	0.75
<b>Bi</b>	<0.0005	-

## Welding parameters (A)

φ mm	1F, 1G, 2F	2G	3G uphill
1.2	130~270	150~220	130~180

Note: <sup>a</sup> Single values are maximum.

## All-weld mechanical properties

	Typical (CO <sub>2</sub> )	Guaranty
<b>0.2%YS (MPa)</b>	390	-
<b>TS (MPa)</b>	540	483min.
<b>EI on 4d (%)</b>	44	30min.
<b>IV 0°C (J)</b>	66	-

# DW-316LP

## Flux cored wire

**Features:** - Applicable for 316 and 316L type steel

**Classification:** AWS A5.22 E316LT1-1/4

**Shielding gas:** CO<sub>2</sub> or Ar-CO<sub>2</sub>

**Polarity:** DCEP

### Welding Positions:

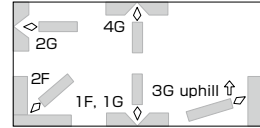

### Packaging data

φ mm	Spool
1.2	12.5kg
<b>Volume mm</b>	295W, 110H, 295L

### Composition (all-weld metal mass%)

	Typical (CO <sub>2</sub> )	Guaranty <sup>a</sup>
<b>C</b>	0.02	0.04
<b>Si</b>	0.8	1.0
<b>Mn</b>	1.3	0.5~2.5
<b>P</b>	0.02	0.04
<b>S</b>	<0.01	0.03
<b>Ni</b>	12.3	11.0~14.0
<b>Cr</b>	18.1	17.0~20.0
<b>Mo</b>	2.8	2.0~3.0
<b>Cu</b>	0.08	0.75
<b>Bi</b>	>0.002	-

Note: <sup>a</sup>Single values are maximum.

### All-weld mechanical properties

	Typical (CO <sub>2</sub> )	Guaranty
<b>0.2%YS (MPa)</b>	370	-
<b>TS (MPa)</b>	540	483min.
<b>EI on 4d (%)</b>	43	30min.
<b>IV 0°C (J)</b>	54	-

### Approvals

	CO <sub>2</sub>	Ar-CO <sub>2</sub>
<b>LR</b>	-	316L S (CHEM)
<b>DNV</b>	VL316L	
<b>BV</b>	316L	-
<b>NK</b>	KW316LG (C)	-
<b>CWB</b>	E316LT1-1	E316LT1-4

### Welding parameters (A)

φ mm	1F, 1G, 2F	2G	3G uphill	4G
1.2	130~270	150~220	130~220	150~200

# DW-316H

## Flux cored wire

- Features:**
- Suitable for 18%Cr-12%Ni-2%Mo steel for high temperature service
  - Bi-free type

## Welding Positions:

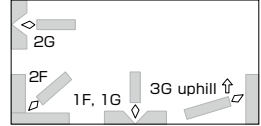

**Classification:** AWS A5.22 E316T1-1/4

**Shielding gas:** CO<sub>2</sub> or Ar-CO<sub>2</sub>

**Polarity:** DCEP

## Packaging data

φ mm	Spool
1.2	12.5kg
Volume mm	295W, 110H, 295L

## Composition (all-weld metal mass%)

	Typical (CO <sub>2</sub> )	Guaranty <sup>a</sup>
<b>C</b>	0.05	0.08
<b>Si</b>	0.4	1.0
<b>Mn</b>	1.1	0.5~2.5
<b>P</b>	0.02	0.04
<b>S</b>	<0.01	0.03
<b>Ni</b>	11.6	11.0~14.0
<b>Cr</b>	18.2	17.0~20.0
<b>Mo</b>	2.4	2.0~3.0
<b>Cu</b>	0.05	0.75
<b>Bi</b>	<0.0005	-

## Welding parameters (A)

φ mm	1F, 1G, 2F	2G	3G uphill
1.2	130~270	150~220	130~180

Note: <sup>a</sup>Single values are maximum.

## All-weld mechanical properties

	Typical (CO <sub>2</sub> )	Guaranty
<b>0.2%YS (MPa)</b>	390	-
<b>TS (MPa)</b>	570	518min.
<b>El on 4d (%)</b>	41	30min.
<b>IV 0°C (J)</b>	68	-

## Flux cored wire

**Features:**

- Applicable for 316L type stainless steel
- Low Cr (VI) stainless steel flux cored wire

**Classification:** AWS A5.22 E316LT0-1/4

**Shielding gas:** CO<sub>2</sub> or Ar-CO<sub>2</sub>

**Polarity:** DCEP

## Welding Positions:

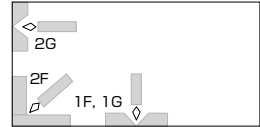

## Packaging data

φ mm	Spool
1.2	12.5kg
<b>Volume mm</b>	295W, 110H, 295L

## Composition (wire mass%)

	Typical (Ar-CO <sub>2</sub> )	Guaranty <sup>a</sup>
<b>C</b>	0.03	0.04
<b>Si</b>	0.7	1.0
<b>Mn</b>	1.3	0.5~2.5
<b>P</b>	0.02	0.04
<b>S</b>	<0.01	0.03
<b>Ni</b>	12.0	11.0~14.0
<b>Cr</b>	18.9	17.0~20.0
<b>Mo</b>	2.4	2.0~3.0
<b>Cu</b>	0.03	0.75

Note: <sup>a</sup> Single values are maximum.

## Welding parameters (A)

φ mm	1F, 1G, 2F	2G
1.2	130~270	150~220

## All-weld mechanical properties

	Typical (Ar-CO <sub>2</sub> )	Guaranty
<b>0.2%YS (MPa)</b>	400	-
<b>TS (MPa)</b>	548	483min.
<b>EI on 4d (%)</b>	42	30min.

## Approvals

CWB	E316LT0-1, E316LT0-4
-----	----------------------

# DW-316LP-XR

# PREMIARC™

## Flux cored wire

- Features:**
- Applicable for 316L type stainless steel
  - Low Cr (VI) stainless steel flux cored wire

**Classification:** AWS A5.22 E316LT1-1/4

**Shielding gas:** CO<sub>2</sub> or Ar-CO<sub>2</sub>

**Polarity:** DCEP

## Welding Positions:

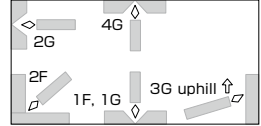

## Packaging data

φ mm	Spool
1.2	12.5kg
<b>Volume mm</b>	295W, 110H, 295L

## Composition (wire mass%)

	Typical (Ar-CO <sub>2</sub> )	Guaranty <sup>a</sup>
<b>C</b>	0.03	0.04
<b>Si</b>	0.8	1.0
<b>Mn</b>	1.2	0.5~2.5
<b>P</b>	0.02	0.04
<b>S</b>	<0.01	0.03
<b>Ni</b>	12.5	11.0~14.0
<b>Cr</b>	19.0	17.0~20.0
<b>Mo</b>	2.8	2.0~3.0
<b>Cu</b>	0.05	0.75

Note: <sup>a</sup>Single values are maximum.

## All-weld mechanical properties

	Typical (Ar-CO <sub>2</sub> )	Guaranty
<b>0.2%YS (MPa)</b>	429	-
<b>TS (MPa)</b>	566	483min.
<b>EI on 4d (%)</b>	41	30min.

## Approvals

<b>ABS*</b>	MG (AWS A5.22 E316LT1-4)
<b>CWB</b>	E316LT1-1, E316LT1-4

Note: \*Ar-25%CO<sub>2</sub>

## Welding parameters (A)

φ mm	1F, 1G, 2F	2G	3G uphill	4G
1.2	130~270	150~220	130~220	150~200

## Flux cored wire

**Features:** • Suitable for 18%Cr-12%Ni-2%Mo-N and 19%Cr-13%Ni-3%Mo steel

**Classification:** AWS A5.22 E317LT0-1/4

**Shielding gas:** CO<sub>2</sub> or Ar-CO<sub>2</sub>

**Polarity:** DCEP

## Welding Positions:

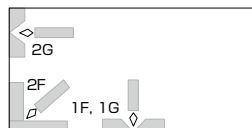

## Packaging data

φ mm	Spool
1.2	12.5kg
<b>Volume mm</b>	295W, 110H, 295L

## Composition (all-weld metal mass%)

	Typical (CO <sub>2</sub> )	Guaranty <sup>a</sup>
<b>C</b>	0.03	0.04
<b>Si</b>	0.4	1.0
<b>Mn</b>	1.0	0.5~2.5
<b>P</b>	0.02	0.04
<b>S</b>	<0.01	0.03
<b>Ni</b>	12.8	12.0~14.0
<b>Cr</b>	18.9	18.0~21.0
<b>Mo</b>	3.1	3.0~4.0
<b>Cu</b>	0.04	0.75
<b>Bi</b>	>0.002	-

Note: <sup>a</sup>Single values are maximum.

## Welding parameters (A)

φ mm	1F, 1G, 2F	2G
1.2	130~270	150~220

## All-weld mechanical properties

	Typical (CO <sub>2</sub> )	Guaranty
<b>0.2%YS (MPa)</b>	380	-
<b>TS (MPa)</b>	590	518min.
<b>EI on 4d (%)</b>	37	20min.
<b>IV 0°C (J)</b>	43	-

## Approvals

<b>LR</b>	MG
<b>DNV</b>	VL317L
<b>BV</b>	UP
<b>NK</b>	KW317LG (C)
<b>CWB</b>	E317LT0-1, E317LT0-4

Note: CO<sub>2</sub>, except in CWB



# DW-317LP

## Flux cored wire

**Features:** ▪ Suitable for 18%Cr-12%Ni-2%Mo-N and 19%Cr-13%Ni-3%Mo stainless steel

**Classification:** AWS A5.22 E317LT1-1/4

**Shielding gas:** CO<sub>2</sub> or Ar-CO<sub>2</sub>

**Polarity:** DCEP

## Welding Positions:

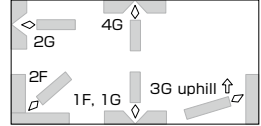

## Packaging data

φ mm	Spool
1.2	12.5kg
<b>Volume mm</b>	295W, 110H, 295L

## Composition (all-weld metal mass%)

	Typical (CO <sub>2</sub> )	Guaranty <sup>a</sup>
<b>C</b>	0.03	0.04
<b>Si</b>	0.6	1.0
<b>Mn</b>	1.3	0.5~2.5
<b>P</b>	0.02	0.04
<b>S</b>	<0.01	0.03
<b>Ni</b>	13.8	12.0~14.0
<b>Cr</b>	18.6	18.0~21.0
<b>Mo</b>	3.3	3.0~4.0
<b>Cu</b>	0.09	0.75
<b>Bi</b>	>0.002	-

Note: <sup>a</sup>Single values are maximum.

## All-weld mechanical properties

	Typical (CO <sub>2</sub> )	Guaranty
<b>0.2%YS (MPa)</b>	435	-
<b>TS (MPa)</b>	582	518min.
<b>El on 4d (%)</b>	37	20min.

## Welding parameters (A)

φ mm	1F, 1G, 2F	2G	3G uphill	4G
1.2	130~270	150~220	130~220	150~200

# DW-347

## Flux cored wire

**Features:** • Suitable for 18%Cr-8%Ni-Nb and 18%Cr-8%Ni-Ti steel

**Classification:** AWS A5.22 E347T0-1/4

**Shielding gas:** CO<sub>2</sub> or Ar-CO<sub>2</sub>

**Polarity:** DCEP

### Welding Positions:

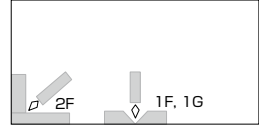

### Packaging data

φ mm	Spool
1.2	12.5kg
1.6	12.5kg
<b>Volume mm</b>	295W, 110H, 295L

### Composition (all-weld metal mass%)

	Typical (CO <sub>2</sub> )	Guaranty <sup>a</sup>
<b>C</b>	0.02	0.08
<b>Si</b>	0.3	1.0
<b>Mn</b>	1.5	0.5~2.5
<b>P</b>	0.02	0.04
<b>S</b>	<0.01	0.03
<b>Ni</b>	10.5	9.0~11.0
<b>Cr</b>	18.6	18.0~21.0
<b>Mo</b>	0.01	0.75
<b>Cu</b>	0.04	0.75
<b>Nb+Ta</b>	0.59	8xC~1.0
<b>Bi</b>	>0.002	-

Note: <sup>a</sup> Single values are maximum.

### Welding parameters (A)

φ mm	1F, 1G, 2F
1.2	130~270
1.6	180~300

### All-weld mechanical properties

	Typical (CO <sub>2</sub> )	Guaranty
<b>0.2%YS (MPa)</b>	390	-
<b>TS (MPa)</b>	550	518min.
<b>EI on 4d (%)</b>	43	30min.
<b>IV 0°C (J)</b>	49	-

### Approvals

<b>CWB</b>	E347T0-1, E347T0-4
------------	--------------------

## Flux cored wire

**Features:** ▪ Suitable for normal duplex stainless steel (S32205, S31803, etc.)

**Classification:** AWS A5.22 E2209T1-1/4

**Shielding gas:** CO<sub>2</sub> or Ar-CO<sub>2</sub>

**Polarity:** DCEP

## Welding Positions:

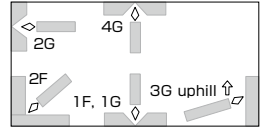

## Packaging data

φ mm	Spool
1.2	12.5kg
Volume mm	295W, 110H, 295L

## Composition (all-weld metal mass%)

	Typical (Ar-CO <sub>2</sub> )	Guaranty <sup>a</sup>
<b>C</b>	0.03	0.04
<b>Si</b>	0.5	1.0
<b>Mn</b>	0.7	0.5~2.0
<b>P</b>	0.02	0.04
<b>S</b>	<0.01	0.03
<b>Ni</b>	9.4	7.5~10.0
<b>Cr</b>	23.0	21.0~24.0
<b>Mo</b>	3.3	2.5~4.0
<b>Cu</b>	0.03	0.75
<b>N</b>	0.14	0.08~0.20

Note: <sup>a</sup>Single values are maximum.

## All-weld mechanical properties

	Typical (Ar-CO <sub>2</sub> )	Guaranty
<b>0.2%YS (MPa)</b>	630	-
<b>TS (MPa)</b>	815	690min.
<b>El on 4d (%)</b>	28	20min.
<b>IV -40°C (J)</b>	60	-

## Approvals

<b>LR</b>	S31803S (CHEM)
<b>CWB</b>	E2209T1-1, E2209T1-4
Note: Ar-CO <sub>2</sub>	

## Welding parameters (A)

φ mm	1F, 1G, 2F	2G	3G uphill	4G
1.2	130~250	150~220	130~180	160~200

## Flux cored wire

**Features:** • Suitable for normal duplex stainless steel (S32205, S31803, etc)

**Classification:** AWS A5.22 E2209T1-1/4

**Shielding gas:** CO<sub>2</sub> or Ar-CO<sub>2</sub>

**Polarity:** DCEP

### Welding Positions:

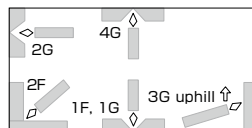

## Packaging data

φ mm	Spool
1.2	12.5kg
<b>Volume mm</b>	295W, 110H, 295L

## Composition (wire mass%)

	Typical (Ar-CO <sub>2</sub> )	Guaranty <sup>a</sup>
<b>C</b>	0.03	0.04
<b>Si</b>	0.61	1.0
<b>Mn</b>	0.74	0.5~2.0
<b>P</b>	0.02	0.04
<b>S</b>	0.01	0.03
<b>Ni</b>	9.10	7.5~10.0
<b>Cr</b>	22.70	21.0~24.0
<b>Mo</b>	3.30	2.5~4.0
<b>Cu</b>	0.02	0.75
<b>N</b>	0.13	0.08~0.20

Note: <sup>a</sup>Single values are maximum.

## All-weld mechanical properties

	Typical (Ar-CO <sub>2</sub> )	Guaranty
<b>0.2%YS (MPa)</b>	639	-
<b>TS (MPa)</b>	820	690min.
<b>EI on 4d (%)</b>	28	20min.
<b>IV -20°C (J)</b>	46	-

## Approvals

	CO <sub>2</sub>	Ar-CO <sub>2</sub>
<b>ABS</b>	MG (AWS A5.22 E2209T1-1)	MG (AWS A5.22 E2209T1-4)
<b>LR</b>	S31803S (CHEM), Dup/CMnS(CHEM)	S31803S (CHEM)
<b>DNV</b>	MG (Duplex)	MG (Duplex)
<b>BV</b>	SA2205	SA2205
<b>NK</b>	KW2209G (C)	KW2209G (M21)
<b>CCS</b>	2205	2205

## Welding parameters (A)

φ mm	1F, 1G, 2F	2G	3G uphill	4G
1.2	130~250	150~220	130~220	160~190

# DW-2307

## Flux cored wire

**Features:**     ▪ Suitable for lean duplex stainless steel of S32101, S32304, S82122

**Classification:** AWS A5.22 E2307T1-1/4

**Shielding gas:** CO<sub>2</sub> or Ar-CO<sub>2</sub>

**Polarity:**       DCEP

### Welding Positions:

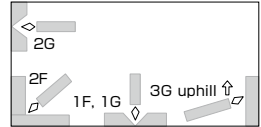

## Packaging data

φ mm	Spool
1.2	12.5kg
<b>Volume mm</b>	295W, 110H, 295L

## Composition (all-weld metal mass%)

	Typical (Ar-CO <sub>2</sub> )	Guaranty <sup>a</sup>
<b>C</b>	0.02	0.04
<b>Si</b>	0.6	1.0
<b>Mn</b>	1.4	2.0
<b>P</b>	0.02	0.03
<b>S</b>	<0.01	0.02
<b>Ni</b>	8.3	6.5~10.0
<b>Cr</b>	24.6	22.5~25.5
<b>Mo</b>	0.05	0.8
<b>Cu</b>	0.03	0.50
<b>N</b>	0.13	0.10~0.20
<b>Bi</b>	>0.002	-

## Welding parameters (A)

φ mm	1F, 1G, 2F	2G	3G uphill
1.2	130~250	150~220	130~180

Note: <sup>a</sup> Single values are maximum.

## All-weld mechanical properties

	Typical (Ar-CO <sub>2</sub> )	Guaranty
<b>0.2%YS (MPa)</b>	590	-
<b>TS (MPa)</b>	754	690min.
<b>EI on 4d (%)</b>	29	20min.
<b>IV 0°C (J)</b>	52	-

# DW-2594

## Flux cored wire

**Features:** • Suitable for super duplex stainless steel (S32750, S32760, etc.)

**Classification:** AWS A5.22 E2594T1-1/4

**Shielding gas:** CO<sub>2</sub> or Ar-CO<sub>2</sub>

**Polarity:** DCEP

### Welding Positions:

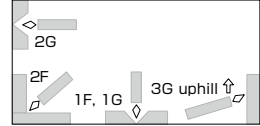

### Packaging data

φ mm	Spool
1.2	12.5kg
<b>Volume mm</b>	295W, 110H, 295L

### Composition (all-weld metal mass%)

	Typical (Ar-CO <sub>2</sub> )	Guaranty <sup>a</sup>
<b>C</b>	0.03	0.04
<b>Si</b>	0.5	1.0
<b>Mn</b>	1.2	0.5~2.5
<b>P</b>	0.02	0.04
<b>S</b>	<0.01	0.03
<b>Ni</b>	9.5	8.0~10.5
<b>Cr</b>	25.5	24.0~27.0
<b>Mo</b>	3.8	2.5~4.5
<b>Cu</b>	<0.1	1.5
<b>W</b>	<0.1	1.0
<b>N</b>	0.22	0.20~0.30

Note: <sup>a</sup> Single values are maximum.

### Welding parameters (A)

φ mm	1F, 1G, 2F	2G	3G uphill
1.2	130~250	150~220	130~180

### All-weld mechanical properties

	Typical (Ar-CO <sub>2</sub> )	Guaranty
<b>0.2%YS (MPa)</b>	714	-
<b>TS (MPa)</b>	896	759min.
<b>EI on 4d (%)</b>	28	15min.
<b>IV -40°C (J)</b>	38	-

### Approvals

<b>ABS</b>	MG
<b>LR</b>	S32750S (CHEM), Dup/CMnS (CHEM)
<b>DNV</b>	MG (AWS A5.22 E2594T1-1)
<b>BV</b>	UP
<b>NK</b>	MG
<b>CWB</b>	E2594T1-1, E2594T1-4

Note: CO<sub>2</sub>, except in CWB

# DW-410Cb

## Flux cored wire

**Features:** ▪ Suitable for 13%Cr martensitic stainless steel such as 403 and 410 types and 13%Cr ferritic stainless steels such as 405 type

### Welding Positions:

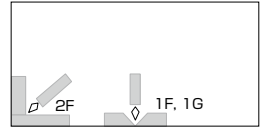

**Classification:** AWS A5.22 E409NbT0-1

**Shielding gas:** CO<sub>2</sub>

**Polarity:** DCEP

### Packaging data

φ mm	Spool
1.2	12.5kg
Volume mm	295W, 110H, 295L

### Composition (all-weld metal mass%)

	Typical (CO <sub>2</sub> )	Guaranty <sup>a</sup>
<b>C</b>	0.05	0.10
<b>Si</b>	0.5	1.0
<b>Mn</b>	0.7	1.2
<b>P</b>	0.03	0.04
<b>S</b>	<0.01	0.03
<b>Ni</b>	0.1	0.6
<b>Cr</b>	12.6	10.5~13.5
<b>Mo</b>	<0.1	0.5
<b>Cu</b>	<0.1	0.5
<b>Nb+Ta</b>	0.64	8xC~1.5
<b>Bi</b>	>0.002	-

### Welding parameters (A)

φ mm	1F, 1G, 2F
1.2	130~270

Note: <sup>a</sup> Single values are maximum.

### All-weld mechanical properties

	Typical (CO <sub>2</sub> )	Guaranty
<b>0.2%YS (MPa)</b>	282	-
<b>TS (MPa)</b>	515	449min.
<b>EI on 4d (%)</b>	30	15min.
<b>IV (J)</b>	-	-
<b>PWHT (°C×h)</b>	775x2	760~790x2

## Flux cored wire

- Features:**
- Suitable for 13%Cr-Ni steel
  - Preheat (100°C) must be done depending on thickness of base metal

**Classification:** AWS A5.22 EC410NiMo

**Shielding gas:** Ar-CO<sub>2</sub>

**Polarity:** DCEP

## Welding Positions:

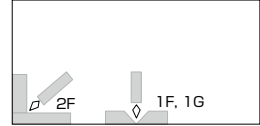

## Packaging data

φ mm	Spool
1.2	12.5kg
Volume mm	295W, 110H, 295L

## Composition (all-weld metal mass%)

	Typical	Guaranty <sup>a</sup>
<b>C</b>	0.02	0.06
<b>Si</b>	0.3	0.5
<b>Mn</b>	0.5	0.6
<b>P</b>	0.02	0.03
<b>S</b>	0.01	0.03
<b>Ni</b>	4.2	4.0~5.0
<b>Cr</b>	12.0	11.0~12.5
<b>Mo</b>	0.5	0.4~0.7
<b>Cu</b>	0.03	0.75

Note: <sup>a</sup>Single values are maximum.

## Welding parameters (A)

φ mm	1F, 1G, 2F
1.2	180~320

## All-weld mechanical properties

	Typical
<b>0.2%YS (MPa)</b>	870
<b>TS (MPa)</b>	920
<b>EI on 4d (%)</b>	20
<b>IV 0°C (J)</b>	64
<b>PWHT (°C×h)</b>	600x1



# MX-A430M

# PREMIARC™

## Flux cored wire

- Features:**
- Suitable for 13~17% Cr ferritic stainless steels
  - Applied for thin plate in short circuiting welding
  - Only use for single pass

### Welding Positions:

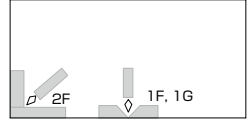

**Classification:** AWS -

**Shielding gas:** Ar-CO<sub>2</sub> or Ar-O<sub>2</sub>

**Polarity:** DCEP

## Packaging data

φ mm	Spool		Drum	
	1.2	20kg	200kg	250kg
<b>Volume mm</b>	295W, 110H, 295L		530 φ, 820H	

## Composition (all-weld metal mass%)

	Typical (Ar-CO <sub>2</sub> )	Guaranty <sup>a</sup>
<b>C</b>	0.05	0.10
<b>Si</b>	0.4	0.9
<b>Mn</b>	0.1	1.0
<b>P</b>	0.01	0.04
<b>S</b>	0.02	0.03
<b>Ni</b>	0.1	0.6
<b>Cr</b>	17.0	15.0~18.5
<b>Nb</b>	0.7	1.0

Note: <sup>a</sup> Single values are maximum.

## Welding parameters (A)

φ mm	1F, 1G, 2F
1.2	100~250

## All-weld mechanical properties

	Typical (Ar-CO <sub>2</sub> )
<b>0.2%YS (MPa)</b>	390
<b>TS (MPa)</b>	540
<b>El on 4d (%)</b>	26
<b>PWHT</b>	AW

## TG-X filler rods for one-side TIG welding

### Tips for using TG-X filler rods

In order to secure a sound back bead with TG-X filler rod, it is essential to follow specific techniques.

- (1) Proper root gap for sufficient penetration

Groove shape	Single V (70°) with 1.0mm shoulder		
Wall thickness (mm)	4	6	10 min.
Root gap (mm)	2.0	2.5	3.0

- (2) Keyhole forming

By forming a key hole during welding, a sufficient amount of molten slag will flow to the back side of the groove and cover the back side of the bead.

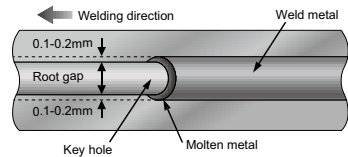

- (3) Higher feeding speed of TG-X filler rod

The feeding speed of TG-X filler rod differs slightly from that of conventional solid TIG filler rod. It has to be fed at a high pace and little by little, with attention paid to not feeding too much at one time.

- (4) Proper welding current and short arc length

Wall thickness (mm)	3-5	6-9	10 min.
Current (A)	80-90	90-105	90-110

It is recommended to keep the nozzle in contact with the groove fusion faces with an appropriate extension of the tungsten (W) electrode.

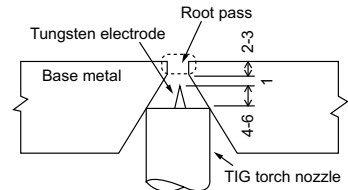

- (5) Crater treatment to avoid crater cracking

Turn the crater onto the groove face to prevent crater cracking as well as shrinkage cavities in the crater.

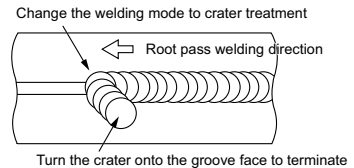

- (6) Bead connection

It is also important to maintain the bead connection properly to prevent oxidation in the penetration bead and to obtain a normal penetration bead contour.

Maintain solid slag both on the crater and the back bead when re-starting an arc to join a preceding bead. The re-arcng point should be placed back from the edge of the crater by about 10 mm.

In 5G position welding, terminate the succeeding bead onto the crater of the preceding bead in the uphill position to control molten slag and thereby to help create the keyhole.

# TG-X308L

## Flux cored filler rod

### Features:

- Applicable for 304 and 304L type steels
- Suitable for root pass in one-side welding without back shielding
- In order to avoid defects, TG-X filler rod must be moved quickly at short pitch, unlike TIG filler rod

### Welding Positions:

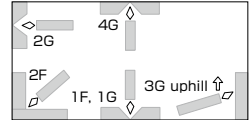

**Classification:** AWS A5.22 R308LT1-5

**Shielding gas:** Ar

**Identification color:** Red

**Polarity:** DCEN

## Packaging data

φ mm	Tube			
	kg	Length mm	g/piece	Volume mm
2.2	5	1,000	26	42W, 35H, 1015L

## Composition (all-weld metal mass%)

	Typical	Guaranty <sup>a</sup>
<b>C</b>	0.02	0.03
<b>Si</b>	0.7	1.2
<b>Mn</b>	1.4	0.5~2.5
<b>P</b>	0.02	0.04
<b>S</b>	<0.01	0.03
<b>Ni</b>	10.3	9.0~11.0
<b>Cr</b>	19.6	18.0~21.0
<b>Mo</b>	0.02	0.75
<b>Cu</b>	0.04	0.75
<b>Bi</b>	>0.002	-

Note: <sup>a</sup> Single values are maximum.

## Welding parameters

thickness mm	3~5	6~9	Over 10
<b>current A</b>	80~90	90~105	90~110

## All-weld mechanical properties

	Typical	Guaranty
<b>0.2%YS (MPa)</b>	450	-
<b>TS (MPa)</b>	620	518min.
<b>EI on 4d (%)</b>	47	30min.
<b>IV -196°C (J)</b>	60	-

## Flux cored filler rod

### Features:

- Applicable for dissimilar-metal joint of stainless steels and ferritic steels
- Suitable for root pass in one-side welding without back shielding
- In order to avoid defects, TG-X filler rod must be moved quickly at short pitch, unlike TIG filler rod

### Welding Positions:

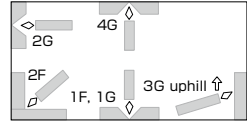

**Classification:** AWS A5.22 R309LT1-5

**Shielding gas:** Ar

**Identification color:** Yellow green

**Polarity:** DCEN

## Packaging data

φ mm	kg	Tube		
		Length mm	g/piece	Volume mm
2.2	5	1,000	26	42W, 35H, 1015L

## Composition (all-weld metal mass%)

	Typical	Guaranty <sup>a</sup>
<b>C</b>	0.02	0.03
<b>Si</b>	0.8	1.2
<b>Mn</b>	1.4	0.5~2.5
<b>P</b>	0.02	0.04
<b>S</b>	<0.01	0.03
<b>Ni</b>	12.1	12.0~14.0
<b>Cr</b>	23.7	22.0~25.0
<b>Mo</b>	0.02	0.75
<b>Cu</b>	0.04	0.75
<b>Bi</b>	>0.002	-

Note: <sup>a</sup>Single values are maximum.

## Welding parameters

thickness mm	3~5	6~9	Over 10
<b>current A</b>	80~90	90~105	90~110

## All-weld mechanical properties

	Typical	Guaranty
<b>0.2%YS (MPa)</b>	530	-
<b>TS (MPa)</b>	680	518min.
<b>EI on 4d (%)</b>	32	30min.

# TG-X316L

## Flux cored filler rod

### Features:

- Applicable for 316 and 316L type steels
- Suitable for root pass in one-side TIG welding without back shielding
- In order to avoid defects, TG-X filler rod must be moved quickly at short pitch, unlike TIG filler rod

### Welding Positions:

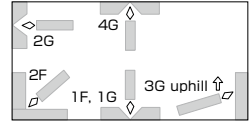

**Classification:** AWS A5.22 R316LT1-5

**Shielding gas:** Ar

**Identification color:** Green

**Polarity:** DCEN

## Packaging data

φ mm	Tube			
	kg	Length mm	g/piece	Volume mm
2.2	5	1,000	26	42W, 35H, 1015L

## Composition (all-weld metal mass%)

	Typical	Guaranty <sup>a</sup>
<b>C</b>	0.02	0.03
<b>Si</b>	0.7	1.2
<b>Mn</b>	1.4	0.5~2.5
<b>P</b>	0.02	0.04
<b>S</b>	<0.01	0.03
<b>Ni</b>	12.0	11.0~14.0
<b>Cr</b>	18.4	17.0~20.0
<b>Mo</b>	2.2	2.0~3.0
<b>Cu</b>	0.05	0.75
<b>Bi</b>	>0.002	-

Note: <sup>a</sup> Single values are maximum.

## Welding parameters

thickness mm	3~5	6~9	Over 10
<b>current A</b>	80~90	90~105	90~110

## All-weld mechanical properties

	Typical	Guaranty
<b>0.2%YS (MPa)</b>	440	-
<b>TS (MPa)</b>	600	483min.
<b>EI on 4d (%)</b>	38	30min.
<b>IV 0°C (J)</b>	110	-

## Approvals

<b>NK</b>	<b>MG</b>
-----------	-----------

# TG-X347

## Flux cored filler rod

- Features:**
- Applicable for 347 and 321 type steels
  - Suitable for root pass in one-side TIG welding without back shielding
  - In order to avoid defects, TG-X filler rod must be moved quickly at short pitch, unlike TIG filler rod

### Welding Positions:

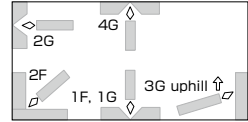

**Classification:** AWS A5.22 R347T1-5

**Shielding gas:** Ar

**Identification color:** Blue

**Polarity:** DCEN

## Packaging data

φ mm	Tube			
	kg	Length mm	g/piece	Volume mm
2.2	5	1,000	26	42W, 35H, 1015L

## Composition (all-weld metal mass%)

	Typical	Guaranty <sup>a</sup>
<b>C</b>	0.02	0.08
<b>Si</b>	0.8	1.2
<b>Mn</b>	1.4	0.5~2.5
<b>P</b>	0.02	0.04
<b>S</b>	<0.01	0.03
<b>Ni</b>	10.2	9.0~11.0
<b>Cr</b>	18.9	18.0~21.0
<b>Nb+Ta</b>	0.60	8xC%~1.0
<b>Mo</b>	0.01	0.75
<b>Cu</b>	0.03	0.75
<b>Bi</b>	>0.002	-

Note: <sup>a</sup>Single values are maximum.

## Welding parameters

thickness mm	3~5	6~9	Over 10
<b>current A</b>	80~90	90~105	90~110

## All-weld mechanical properties

	Typical	Guaranty
<b>0.2%YS (MPa)</b>	460	-
<b>TS (MPa)</b>	630	518min.
<b>EI on 4d (%)</b>	48	30min.
<b>IV 0°C (J)</b>	130	-

## Solid wire

**Features:**     ▪ Suitable for 18%Cr-8%Ni steel

**Classification:** AWS A5.9 ER308

**Shielding gas:** Ar-2%O<sub>2</sub>

**Polarity:**       DCEP

## Welding Positions:

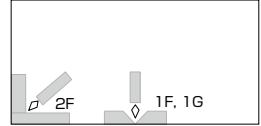

## Packaging data

φ mm	Spool		Drum	
0.8	10kg	-	-	-
0.9	-	20kg	-	-
1.0	-	20kg	200kg	-
1.2	-	20kg	-	250kg
<b>Volume mm</b>	240W, 110H, 240L	285W, 110H, 285L	530 φ, 820H	

## Composition (wire mass%)

	Typical	Guaranty <sup>a</sup>
<b>C</b>	0.04	0.08
<b>Si</b>	0.43	0.30~0.65
<b>Mn</b>	1.7	1.0~2.5
<b>P</b>	0.02	0.03
<b>S</b>	<0.01	0.03
<b>Ni</b>	9.7	9.0~11.0
<b>Cr</b>	19.9	19.5~22.0
<b>Mo</b>	0.08	0.75
<b>Cu</b>	0.11	0.75

Note: <sup>a</sup> Single values are maximum.

## Welding parameters (A)

φ mm	1F, 1G, 2F
0.8	50~150
0.9	70~200
1.0	80~250
1.2	100~300

## All-weld mechanical properties

	Typical
<b>0.2%YS (MPa)</b>	410
<b>TS (MPa)</b>	600
<b>El on 4d (%)</b>	40
<b>IV -196°C (J)</b>	49

## Solid wire

**Features:** • Suitable for low carbon 18%Cr-8%Ni steel

**Classification:** AWS A5.9 ER308LSi

**Shielding gas:** Ar-2%O<sub>2</sub>

**Polarity:** DCEP

## Welding Positions:

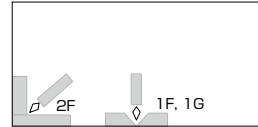

## Packaging data

φ mm	Spool	
0.8	10kg	-
0.9	10kg	-
1.0	10kg	20kg
1.2	10kg	20kg
<b>Volume mm</b>	240W, 110H, 240L	285W, 110H, 285L

## Composition (wire mass%)

	Typical	Guaranty <sup>a</sup>
<b>C</b>	0.02	0.03
<b>Si</b>	0.79	0.65~1.00
<b>Mn</b>	1.9	1.0~2.5
<b>P</b>	0.02	0.03
<b>S</b>	<0.01	0.03
<b>Ni</b>	9.9	9.0~11.0
<b>Cr</b>	19.8	19.5~22.0
<b>Mo</b>	0.04	0.75
<b>Cu</b>	0.04	0.75

## Welding parameters (A)

φ mm	1F, 1G, 2F
0.8	50~150
0.9	70~200
1.0	80~250
1.2	100~300

Note: <sup>a</sup> Single values are maximum.

## All-weld mechanical properties

	Typical
<b>0.2%YS (MPa)</b>	400
<b>TS (MPa)</b>	580
<b>EI on 4d (%)</b>	42
<b>IV -196°C (J)</b>	59



## Solid wire

**Features:** ▪ Suitable for dissimilar-metal joint and underlaying on ferritic steels for overlaying stainless steel weld metals

## Welding Positions:

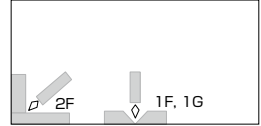

**Classification:** AWS A5.9 ER309

**Shielding gas:** Ar-2%O<sub>2</sub>

**Polarity:** DCEP

## Packaging data

φ mm	Spool	
0.9	10kg	-
1.0	10kg	20kg
1.2	10kg	20kg
<b>Volume mm</b>	240W, 110H, 240L	285W, 110H, 285L

## Composition (wire mass%)

	Typical	Guaranty <sup>a</sup>
<b>C</b>	0.05	0.12
<b>Si</b>	0.46	0.30~0.65
<b>Mn</b>	2.0	1.0~2.5
<b>P</b>	0.02	0.03
<b>S</b>	<0.01	0.03
<b>Ni</b>	13.7	12.0~14.0
<b>Cr</b>	23.3	23.0~25.0
<b>Mo</b>	0.03	0.75
<b>Cu</b>	0.03	0.75

Note: <sup>a</sup> Single values are maximum.

## Welding parameters (A)

φ mm	1F, 1G, 2F
0.9	70~200
1.0	80~250
1.2	100~300

## All-weld mechanical properties

	Typical
<b>0.2%YS (MPa)</b>	430
<b>TS (MPa)</b>	610
<b>EI on 4d (%)</b>	39

## Solid wire

**Features:** • Suitable for dissimilar-metal joint and underlaying on ferritic steels for overlaying stainless steel weld metals

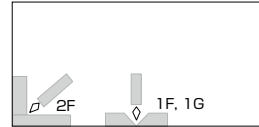
**Welding Positions:**

**Classification:** AWS A5.9 ER309LSi

**Shielding gas:** Ar-2%O<sub>2</sub>

**Polarity:** DCEP

## Packaging data

φ mm	Spool	
	10kg	20kg
1.2	240W, 110H, 240L	285W, 110H, 285L

## Composition (wire mass%)

	Typical	Guaranty <sup>a</sup>
<b>C</b>	0.02	0.03
<b>Si</b>	0.84	0.65~1.00
<b>Mn</b>	1.8	1.0~2.5
<b>P</b>	0.02	0.03
<b>S</b>	<0.01	0.03
<b>Ni</b>	13.3	12.0~14.0
<b>Cr</b>	23.6	23.0~25.0
<b>Mo</b>	0.03	0.75
<b>Cu</b>	0.03	0.75

## Welding parameters (A)

φ mm	1F, 1G, 2F
1.2	100~300

Note: <sup>a</sup>Single values are maximum.

## All-weld mechanical properties

	Typical
<b>0.2%YS (MPa)</b>	410
<b>TS (MPa)</b>	570
<b>EI on 4d (%)</b>	40
<b>IV 0°C (J)</b>	88

# MG-S316LS

## Solid wire

**Features:** • Suitable for low carbon 18%Cr-12%Ni-2%Mo steel

**Classification:** AWS A5.9 ER316LSi

**Shielding gas:** Ar-2%O<sub>2</sub>

**Polarity:** DCEP

## Welding Positions:

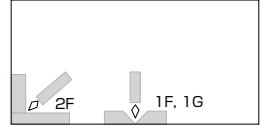

## Packaging data

φ mm	Spool	
1.0	10kg	-
1.2	10kg	20kg
<b>Volume mm</b>	240W, 110H, 240L	285W, 110H, 285L

## Composition (wire mass%)

	Typical	Guaranty <sup>a</sup>
<b>C</b>	0.02	0.03
<b>Si</b>	0.79	0.65~1.00
<b>Mn</b>	2.0	1.0~2.5
<b>P</b>	0.02	0.03
<b>S</b>	<0.01	0.03
<b>Ni</b>	12.2	11.0~14.0
<b>Cr</b>	19.3	18.0~20.0
<b>Mo</b>	2.4	2.0~3.0
<b>Cu</b>	0.12	0.75

Note: <sup>a</sup> Single values are maximum.

## Welding parameters (A)

φ mm	1F, 1G, 2F
1.0	80~250
1.2	100~300

## All-weld mechanical properties

	Typical
<b>0.2%YS (MPa)</b>	380
<b>TS (MPa)</b>	550
<b>El on 4d (%)</b>	41
<b>IV -196°C (J)</b>	39

## Filler rod and wire

<b>Features:</b>	▪ Suitable for 18%Cr-8%Ni steel
<b>Classification:</b>	AWS A5.9 ER308
<b>Shielding gas:</b>	Ar
<b>Identification color:</b>	1st Yellow
<b>Polarity:</b>	DCEN

## Packaging data

φ mm	Spool	Tube		
	kg	kg	Length mm	g/piece
0.8	-	5	1,000	4
1.0	-	5	1,000	6
1.2	10	5	1,000	9
1.6	10	5	1,000	16
2.0	-	5	1,000	25
2.4	-	5	1,000	36
3.2	-	5	1,000	64
<b>Volume mm</b>	240W, 110H, 240L	40W, 35H, 1015L		

## Composition (rod and wire mass%)

	Typical	Guaranty <sup>a</sup>
<b>C</b>	0.05	0.08
<b>Si</b>	0.38	0.30~0.65
<b>Mn</b>	1.5	1.0~2.5
<b>P</b>	0.02	0.03
<b>S</b>	<0.01	0.03
<b>Ni</b>	9.5	9.0~11.0
<b>Cr</b>	19.9	19.5~22.0
<b>Mo</b>	0.11	0.75
<b>Cu</b>	0.12	0.75

Note: <sup>a</sup> Single values are maximum.

## Welding parameters (A)

φ mm	
0.8	50~80
1.0	50~80
1.2	50~100
1.6	100~200
2.0	100~200
2.4	150~250
3.2	200~300

## All-weld mechanical properties

	Typical
<b>0.2%YS (MPa)</b>	410
<b>TS (MPa)</b>	580
<b>EI on 4d (%)</b>	42
<b>IV 0°C (J)</b>	150

## Approvals

<b>ABS</b>	MG (AWS A5.9 ER308)
<b>DNV</b>	VL308
<b>NK</b>	KY308

## Filler rod and wire

**Features:** • Suitable for low carbon 18%Cr-8%Ni steel

**Classification:** AWS A5.9 ER308L

**Shielding gas:** Ar

**Identification color:** 1st Red

**Polarity:** DCEN

## Packaging data

ϕ mm	Spool		Tube		
	kg	kg	Length mm	g/piece	
0.8	10	5	1,000	4	
1.0	10	5	1,000	6	
1.2	10	5	1,000	9	
1.6	10	5	1,000	16	
2.0	-	5	1,000	25	
2.4	-	5	1,000	36	
3.2	-	5	1,000	64	
<b>Volume mm</b>	240W, 110H, 240L		40W, 35H, 1015L		

## Composition (rod and wire mass%)

	Typical	Guaranty <sup>a</sup>
<b>C</b>	0.01	0.03
<b>Si</b>	0.37	0.30~0.65
<b>Mn</b>	1.8	1.0~2.5
<b>P</b>	0.02	0.03
<b>S</b>	<0.01	0.03
<b>Ni</b>	10.1	9.0~11.0
<b>Cr</b>	19.8	19.5~22.0
<b>Mo</b>	0.07	0.75
<b>Cu</b>	0.08	0.75

Note: <sup>a</sup> Single values are maximum.

## Welding parameters (A)

ϕ mm	
0.8	50~80
1.0	50~80
1.2	50~100
1.6	100~200
2.0	100~200
2.4	150~250
3.2	200~300

## All-weld mechanical properties

	Typical
<b>0.2%YS (MPa)</b>	420
<b>TS (MPa)</b>	590
<b>El on 4d (%)</b>	45
<b>IV -196°C (J)</b>	78

## Approvals

<b>ABS</b>	MG (AWS A5.9 ER308L)
<b>LR</b>	304L m (CHEM & CRYO)
<b>DNV</b>	VL308L, MG
<b>BV</b>	308LBT
<b>NK</b>	KY308L

## Filler rod and wire

<b>Features:</b>	▪ Suitable for dissimilar-metal joint and underlaying on ferritic steels
<b>Classification:</b>	AWS A5.9 ER309
<b>Shielding gas:</b>	Ar
<b>Identification color:</b>	1st Black
<b>Polarity:</b>	DCEN

## Packaging data

φ mm	Spool		Tube	
	kg	kg	Length mm	g/piece
1.0	10	5	1,000	6
1.2	10	5	1,000	9
1.6	10	5	1,000	16
2.0	-	5	1,000	25
2.4	-	5	1,000	36
3.2	-	5	1,000	64
<b>Volume mm</b>	240W, 110H, 240L		40W, 35H, 1015L	

## Composition (rod and wire mass%)

	Typical	Guaranty <sup>a</sup>
<b>C</b>	0.05	0.12
<b>Si</b>	0.47	0.30~0.65
<b>Mn</b>	1.6	1.0~2.5
<b>P</b>	0.02	0.03
<b>S</b>	<0.01	0.03
<b>Ni</b>	13.6	12.0~14.0
<b>Cr</b>	23.1	23.0~25.0
<b>Mo</b>	0.10	0.75
<b>Cu</b>	0.12	0.75

Note: <sup>a</sup> Single values are maximum.

## Welding parameters (A)

φ mm	
1.0	50~80
1.2	50~100
1.6	100~200
2.0	100~200
2.4	150~250
3.2	200~300

## All-weld mechanical properties

	Typical
<b>0.2%YS (MPa)</b>	410
<b>TS (MPa)</b>	580
<b>EI on 4d (%)</b>	39
<b>IV 0°C (J)</b>	150

## Approvals

<b>DNV</b>	VL309
<b>NK</b>	KY309

## Filler rod and wire

<b>Features:</b>	▪ Suitable for dissimilar-metal joint and underlaying on ferritic steels
<b>Classification:</b>	AWS A5.9 ER309L
<b>Shielding gas:</b>	Ar
<b>Identification color:</b>	1st Yellow green
<b>Polarity:</b>	DCEN

## Packaging data

φ mm	Spool		Tube	
	kg	kg	Length mm	g/piece
0.9	10	-	-	-
1.2	10	5	1,000	9
1.6	10	5	1,000	16
2.0	-	5	1,000	25
2.4	-	5	1,000	36
3.2	-	5	1,000	64
<b>Volume mm</b>	240W, 110H, 240L		40W, 35H, 1015L	

## Composition (rod and wire mass%)

	Typical	Guaranty <sup>a</sup>
<b>C</b>	0.01	0.03
<b>Si</b>	0.42	0.30~0.65
<b>Mn</b>	1.7	1.0~2.5
<b>P</b>	0.02	0.03
<b>S</b>	<0.01	0.03
<b>Ni</b>	13.5	12.0~14.0
<b>Cr</b>	23.3	23.0~25.0
<b>Mo</b>	0.04	0.75
<b>Cu</b>	0.05	0.75

Note: <sup>a</sup> Single values are maximum.

## Welding parameters (A)

φ mm	
0.9	50~80
1.2	50~100
1.6	100~200
2.0	100~200
2.4	150~250
3.2	200~300

## All-weld mechanical properties

	Typical
<b>0.2%YS (MPa)</b>	410
<b>TS (MPa)</b>	570
<b>EI on 4d (%)</b>	38
<b>IV 0°C (J)</b>	110

## Approvals

<b>LR</b>	SS/CMn m (CHEM & CRYO), Dup/CMn m (CHEM)
<b>NK</b>	KY309L

## Filler rod and wire

<b>Features:</b>	▪ Suitable for dissimilar-metal joint and underlaying on ferritic steels
<b>Classification:</b>	AWS A5.9 ER309LMo
<b>Shielding gas:</b>	Ar
<b>Identification color:</b>	1st Silver, 2nd Red
<b>Polarity:</b>	DCEN

## Packaging data

φ mm	Spool		Tube	
	kg	kg	Length mm	g/piece
1.2	10	5	1,000	9
1.6	-	5	1,000	16
2.0	-	5	1,000	25
2.4	-	5	1,000	36
3.2	-	5	1,000	64
<b>Volume mm</b>	240W, 110H, 240L		40W, 35H, 1015L	

## Composition (rod and wire mass%)

	Typical	Guaranty <sup>a</sup>
<b>C</b>	0.02	0.03
<b>Si</b>	0.43	0.30~0.65
<b>Mn</b>	2.1	1.0~2.5
<b>P</b>	0.02	0.03
<b>S</b>	<0.01	0.03
<b>Ni</b>	13.6	12.0~14.0
<b>Cr</b>	23.5	23.0~25.0
<b>Mo</b>	2.2	2.0~3.0
<b>Cu</b>	0.05	0.75

Note: <sup>a</sup> Single values are maximum.

## Welding parameters (A)

φ mm	
1.2	50~100
1.6	100~200
2.0	100~200
2.4	150~250
3.2	200~300

## All-weld mechanical properties

	Typical
<b>0.2%YS (MPa)</b>	440
<b>TS (MPa)</b>	590
<b>EI on 4d (%)</b>	36

## Approvals

<b>NK</b>	KY309Mo
-----------	---------



## Filler rod and wire

<b>Features:</b>	▪ Suitable for 25%Cr-20%Ni steel
<b>Classification:</b>	AWS A5.9 ER310
<b>Shielding gas:</b>	Ar
<b>Identification color:</b>	1st Gold
<b>Polarity:</b>	DCEN

## Packaging data

φ mm	Spool	Tube		
	kg	kg	Length mm	g/piece
1.0	10	-	-	-
1.6	-	5	1,000	16
2.0	-	5	1,000	25
2.4	-	5	1,000	36
<b>Volume mm</b>	240W, 110H, 240L	40W, 35H, 1015L		

## Composition (rod and wire mass%)

	Typical	Guaranty <sup>a</sup>
<b>C</b>	0.11	0.08~0.15
<b>Si</b>	0.49	0.30~0.65
<b>Mn</b>	1.8	1.0~2.5
<b>P</b>	0.01	0.03
<b>S</b>	<0.01	0.03
<b>Ni</b>	21.2	20.0~22.5
<b>Cr</b>	26.7	25.0~28.0
<b>Mo</b>	0.02	0.75
<b>Cu</b>	0.02	0.75

Note: <sup>a</sup>Single values are maximum.

## Welding parameters (A)

φ mm	
1.0	50~80
1.6	100~200
2.0	100~200
2.4	150~250

## All-weld mechanical properties

	Typical
<b>0.2%YS (MPa)</b>	450
<b>TS (MPa)</b>	610
<b>El on 4d (%)</b>	39
<b>IV 0°C (J)</b>	110

## Filler rod and wire

<b>Features:</b>	▪ Suitable for 18%Cr-12%Ni-2%Mo steel
<b>Classification:</b>	AWS A5.9 ER316
<b>Shielding gas:</b>	Ar
<b>Identification color:</b>	1st White
<b>Polarity:</b>	DCEN

## Packaging data

φ mm	Spool		Tube	
	kg	kg	Length mm	g/piece
1.0	10	5	1,000	6
1.2	10	5	1,000	9
1.6	10	5	1,000	16
2.0	-	5	1,000	25
2.4	-	5	1,000	36
3.2	-	5	1,000	64
<b>Volume mm</b>	240W, 110H, 240L		40W, 35H, 1015L	

## Composition (rod and wire mass%)

	Typical	Guaranty <sup>a</sup>
<b>C</b>	0.04	0.08
<b>Si</b>	0.47	0.30~0.65
<b>Mn</b>	1.5	1.0~2.5
<b>P</b>	0.03	0.03
<b>S</b>	<0.01	0.03
<b>Ni</b>	12.0	11.0~14.0
<b>Cr</b>	19.1	18.0~20.0
<b>Mo</b>	2.1	2.0~3.0
<b>Cu</b>	0.26	0.75

## Welding parameters (A)

φ mm	
1.0	50~80
1.2	50~100
1.6	100~200
2.0	100~200
2.4	150~250
3.2	200~300

Note: <sup>a</sup> Single values are maximum.

## All-weld mechanical properties

	Typical
<b>0.2%YS (MPa)</b>	390
<b>TS (MPa)</b>	570
<b>EI on 4d (%)</b>	42
<b>IV 0°C (J)</b>	110

## Filler rod and wire

<b>Features:</b>	▪ Suitable for low carbon 18%Cr-12%Ni-2%Mo steel
<b>Classification:</b>	AWS A5.9 ER316L
<b>Shielding gas:</b>	Ar
<b>Identification color:</b>	1st Green
<b>Polarity:</b>	DCEN

## Packaging data

φ mm	Spool	Tube		
	kg	kg	Length mm	g/piece
0.8	10	5	1,000	4
1.0	10	5	1,000	6
1.2	10	5	1,000	9
1.6	10	5	1,000	16
2.0	-	5	1,000	25
2.4	-	5	1,000	36
3.2	-	5	1,000	64
<b>Volume mm</b>	240W, 110H, 240L	40W, 35H, 1015L		

## Composition (rod and wire mass%)

	Typical	Guaranty <sup>a</sup>
<b>C</b>	0.01	0.03
<b>Si</b>	0.40	0.30~0.65
<b>Mn</b>	1.7	1.0~2.5
<b>P</b>	0.02	0.03
<b>S</b>	<0.01	0.03
<b>Ni</b>	12.0	11.0~14.0
<b>Cr</b>	18.7	18.0~20.0
<b>Mo</b>	2.2	2.0~3.0
<b>Cu</b>	0.11	0.75

Note: <sup>a</sup> Single values are maximum.

## Welding parameters (A)

φ mm	
0.8	50~80
1.0	50~80
1.2	50~100
1.6	100~200
2.0	100~200
2.4	150~250
3.2	200~300

## All-weld mechanical properties

	Typical
<b>0.2%YS (MPa)</b>	390
<b>TS (MPa)</b>	550
<b>El on 4d (%)</b>	43
<b>IV -196°C (J)</b>	49

## Approvals

<b>ABS</b>	MG (AWS A5.9 ER316L)
<b>LR</b>	316LS (CHEM & CRYO)
<b>DNV</b>	VL316L, MG
<b>BV</b>	316LBT
<b>NK</b>	KY316L

## Filler rod and wire

**Features:**                   ▪ Suitable for low carbon 18%Cr-12%Ni-2%Mo-N and low carbon 19%Cr-13%Ni-3%Mo steel

**Classification:**        AWS A5.9 ER317L

**Shielding gas:**         Ar

**Identification color:** 1st Sorrel

**Polarity:**                 DCEN

## Packaging data

φ mm	Spool	Tube		
	kg	kg	Length mm	g/piece
1.6	10	5	1,000	16
2.0	-	5	1,000	25
2.4	-	5	1,000	36
3.2	-	5	1,000	64
<b>Volume mm</b>	240W, 110H, 240L	40W, 35H, 1015L		

## Composition (rod and wire mass%)

	Typical	Guaranty <sup>a</sup>
<b>C</b>	0.01	0.03
<b>Si</b>	0.43	0.30~0.65
<b>Mn</b>	1.8	1.0~2.5
<b>P</b>	0.02	0.03
<b>S</b>	<0.01	0.03
<b>Ni</b>	13.1	13.0~15.0
<b>Cr</b>	18.8	18.5~20.5
<b>Mo</b>	3.4	3.0~4.0
<b>Cu</b>	0.04	0.75

## Welding parameters (A)

φ mm	
1.6	100~200
2.0	100~200
2.4	150~250
3.2	200~300

Note: <sup>a</sup> Single values are maximum.

## All-weld mechanical properties

	Typical
<b>0.2%YS (MPa)</b>	410
<b>TS (MPa)</b>	570
<b>EI on 4d (%)</b>	39
<b>IV 0°C (J)</b>	98

## Filler rod and wire

<b>Features:</b>	▪ Suitable for 18%Cr-8%Ni-Nb and 18%Cr-8%Ni-Ti steel
<b>Classification:</b>	AWS A5.9 ER347
<b>Shielding gas:</b>	Ar
<b>Identification color:</b>	1st Blue
<b>Polarity:</b>	DCEN

## Packaging data

φ mm	Spool		Tube	
	kg	kg	Length mm	g/piece
1.0	10	-	-	-
1.2	10	5	1,000	9
1.6	10	5	1,000	16
2.0	-	5	1,000	25
2.4	-	5	1,000	36
3.2	-	5	1,000	64
<b>Volume mm</b>	240W, 110H, 240L		40W, 35H, 1015L	

## Composition (rod and wire mass%)

	Typical	Guaranty <sup>a</sup>
<b>C</b>	0.05	0.08
<b>Si</b>	0.40	0.30~0.65
<b>Mn</b>	2.1	1.0~2.5
<b>P</b>	0.02	0.03
<b>S</b>	0.01	0.03
<b>Ni</b>	10.0	9.0~11.0
<b>Cr</b>	19.3	19.0~21.5
<b>Mo</b>	0.07	0.75
<b>Cu</b>	0.07	0.75
<b>Nb</b>	0.6	10xC~1.0

Note: <sup>a</sup> Single values are maximum.

## Welding parameters (A)

φ mm	
1.0	50~80
1.2	50~100
1.6	100~200
2.0	100~200
2.4	150~250
3.2	200~300

## All-weld mechanical properties

	Typical
<b>0.2%YS (MPa)</b>	460
<b>TS (MPa)</b>	630
<b>El on 4d (%)</b>	38
<b>IV 0°C (J)</b>	88

## Approvals

NK	KY347

## Filler rod and wire

<b>Features:</b>	▪ Suitable for 13%Cr stainless steel
<b>Classification:</b>	AWS A5.9 ER410
<b>Shielding gas:</b>	Ar
<b>Identification color:</b>	1st Purple
<b>Polarity:</b>	DCEN

## Packaging data

φ mm	Spool	Tube		
	kg	kg	Length mm	g/piece
1.2	10	-	-	-
1.6	-	5	1,000	16
2.0	-	5	1,000	25
2.4	-	5	1,000	36
<b>Volume mm</b>	240W, 110H, 240L	40W, 35H, 1015L		

## Composition (rod and wire mass%)

	Typical	Guaranty <sup>a</sup>
<b>C</b>	0.10	0.12
<b>Si</b>	0.3	0.5
<b>Mn</b>	0.5	0.6
<b>P</b>	0.01	0.03
<b>S</b>	0.01	0.03
<b>Ni</b>	0.4	0.6
<b>Cr</b>	12.8	11.5~13.5
<b>Mo</b>	0.50	0.75
<b>Cu</b>	<0.01	0.75

## Welding parameters (A)

φ mm	
1.2	50~100
1.6	100~200
2.0	100~200
2.4	150~250

Note: <sup>a</sup>Single values are maximum.

## All-weld mechanical properties

	Typical
<b>0.2%YS (MPa)</b>	520
<b>TS (MPa)</b>	660
<b>EI on 4d (%)</b>	25
<b>PWHT (°C×h)</b>	760×1, FC

## Filler rod and wire

<b>Features:</b>	▪ Suitable for normal duplex stainless steel (S32205, S31803, etc.)
<b>Classification:</b>	AWS A5.9 ER2209
<b>Shielding gas:</b>	Ar or Ar-2%N <sub>2</sub>
<b>Identification color:</b>	1st Red, 2nd Green
<b>Polarity:</b>	DCEN

## Packaging data

φ mm	Spool	Tube		
	kg	kg	Length mm	g/piece
1.2	10	5	1,000	9
1.6	-	5	1,000	16
2.0	-	5	1,000	25
2.4	-	5	1,000	36
3.2	-	5	1,000	64
<b>Volume mm</b>	240W, 110H, 240L	40W, 35H, 1015L		

## Composition (rod and wire mass%)

	Typical	Guaranty <sup>a</sup>
<b>C</b>	0.01	0.03
<b>Si</b>	0.38	0.90
<b>Mn</b>	1.49	0.50~2.00
<b>P</b>	0.02	0.03
<b>S</b>	<0.01	0.03
<b>Ni</b>	8.6	7.5~9.5
<b>Cr</b>	23.0	21.5~23.5
<b>Mo</b>	3.3	2.5~3.5
<b>Cu</b>	0.05	0.75
<b>N</b>	0.15	0.08~0.20

Note: <sup>a</sup> Single values are maximum.

## Welding parameters (A)

φ mm	
1.2	50~100
1.6	100~200
2.0	100~200
2.4	150~250
3.2	200~300

## All-weld mechanical properties

	Typical
<b>0.2%YS (MPa)</b>	615
<b>TS (MPa)</b>	814
<b>EI on 4d (%)</b>	38
<b>IV -50°C (J)</b>	150

## Filler rod and wire

<b>Features:</b>	▪ Suitable for super duplex stainless steel (S32750, S32760, etc.)
<b>Classification:</b>	AWS A5.9 ER2594
<b>Shielding gas:</b>	Ar or Ar-2%N <sub>2</sub>
<b>Identification color:</b>	1st Red, 2nd Blue
<b>Polarity:</b>	DCEN

## Packaging data

φ mm	Spool		Tube	
	kg	kg	Length mm	g/piece
1.2	10	5	1,000	9
1.6	-	5	1,000	16
2.0	-	5	1,000	25
2.4	-	5	1,000	36
3.2	-	5	1,000	64
<b>Volume mm</b>	240W, 110H, 240L		40W, 35H, 1015L	

## Composition (rod and wire mass%)

	Typical	Guaranty <sup>a</sup>
<b>C</b>	0.01	0.03
<b>Si</b>	0.4	1.0
<b>Mn</b>	0.6	2.5
<b>P</b>	0.02	0.03
<b>S</b>	<0.01	0.02
<b>Ni</b>	9.2	8.0~10.5
<b>Cr</b>	24.8	24.0~27.0
<b>Mo</b>	3.8	2.5~4.5
<b>Cu</b>	0.1	1.5
<b>N</b>	0.26	0.20~0.30

Note: <sup>a</sup>Single values are maximum.

## Welding parameters (A)

φ mm	
1.2	50~100
1.6	100~200
2.0	100~200
2.4	150~250
3.2	200~300

## All-weld mechanical properties

	Typical (Ar-2%N <sub>2</sub> )
<b>0.2%YS (MPa)</b>	646
<b>TS (MPa)</b>	859
<b>EI on 4d (%)</b>	38
<b>IV -50°C (J)</b>	171

## Approvals

<b>ABS</b>	MG (AWS A5.9 ER2594)
<b>LR</b>	S32750m (CHEM)
<b>DNV</b>	MG (Super duplex)
<b>BV</b>	UP (AWS A5.9 ER2594)
<b>NK</b>	MG
<b>CCS</b>	2750



## Filler rod and wire

<b>Features:</b>	▪ Suitable for 25%Cr-22%Ni-2%Mo steel of urea plant
<b>Classification:</b>	AWS -
<b>Shielding gas:</b>	Ar
<b>Identification color:</b>	-
<b>Polarity:</b>	DCEN

## Packaging data

φ mm	Spool	Tube		
	kg	kg	Length mm	g/piece
0.8	-	5	1,000	4
1.2	10	5	1,000	9
1.6	-	5	1,000	16
2.0	-	5	1,000	25
2.4	-	5	1,000	36
<b>Volume mm</b>	240W, 110H, 240L	40W, 35H, 1015L		

## Composition (rod and wire mass%)

	Typical	Guaranty <sup>a</sup>
<b>C</b>	0.009	0.020
<b>Si</b>	0.03	0.50
<b>Mn</b>	4.87	3.00~5.50
<b>P</b>	0.005	0.030
<b>S</b>	0.002	0.020
<b>Ni</b>	22.52	21.00~23.00
<b>Cr</b>	25.33	24.00~26.00
<b>Mo</b>	2.27	1.90~2.70
<b>N</b>	0.13	0.20

Note: <sup>a</sup> Single values are maximum.

## Welding parameters (A)

φ mm	
0.8	50~80
1.2	50~100
1.6	100~200
2.0	100~200
2.4	150~250

## All-weld mechanical properties

	Typical
<b>0.2%YS (MPa)</b>	480
<b>TS (MPa)</b>	630
<b>EI on 4d (%)</b>	40

## Filler rod and wire

**Features:**                   ▪ Suitable for 13%Cr and 13%Cr-Al steel

**Classification:**       AWS -

**Shielding gas:**       Ar

**Identification color:** 1st Purple

**Polarity:**               DCEN

## Packaging data

φ mm	Spool		Tube	
	kg	kg	Length mm	g/piece
1.2	10	5	1,000	9
1.6	10	5	1,000	16
2.0	-	5	1,000	25
2.4	-	5	1,000	36
3.2	-	5	1,000	64
<b>Volume mm</b>	240W, 110H, 240L		40W, 35H, 1015L	

## Composition (rod and wire mass%)

	Typical	Guaranty <sup>a</sup>
<b>C</b>	0.09	0.12
<b>Si</b>	0.41	0.50
<b>Mn</b>	0.46	0.60
<b>P</b>	0.007	0.030
<b>S</b>	0.002	0.030
<b>Ni</b>	0.07	0.60
<b>Cr</b>	11.93	11.50~13.50
<b>Mo</b>	0.01	0.75
<b>Cu</b>	0.01	0.75
<b>Nb</b>	0.89	0.70~1.10

## Welding parameters (A)

φ mm	
1.2	50~100
1.6	100~200
2.0	100~200
2.4	150~250
3.2	200~300

Note: <sup>a</sup> Single values are maximum.

## All-weld mechanical properties

	Typical
<b>0.2%YS (MPa)</b>	270
<b>TS (MPa)</b>	540
<b>EI on 4d (%)</b>	23
<b>IV 20°C (J)</b>	39

## Filler rod and wire

<b>Features:</b>	▪ Suitable for modified 316 stainless steel of urea plant
<b>Classification:</b>	AWS -
<b>Shielding gas:</b>	Ar
<b>Identification color:</b>	-
<b>Polarity:</b>	DCEN

## Packaging data

φ mm	Spool	Tube		
	kg	kg	Length mm	g/piece
1.0	10	5	1,000	6
1.2	10	5	1,000	9
1.6	10	5	1,000	16
2.0	-	5	1,000	25
2.4	-	5	1,000	36
<b>Volume mm</b>	240W, 110H, 240L	40W, 35H, 1015L		

## Composition (rod and wire mass%)

	Typical	Guaranty <sup>a</sup>
<b>C</b>	0.005	0.045
<b>Si</b>	0.16	1.00
<b>Mn</b>	6.10	4.00~7.00
<b>P</b>	0.011	0.030
<b>S</b>	0.004	0.020
<b>Ni</b>	16.29	14.00~18.00
<b>Cr</b>	18.24	17.00~19.50
<b>Mo</b>	2.56	2.20~3.00
<b>N</b>	0.01	0.20

Note: <sup>a</sup> Single values are maximum.

## Welding parameters (A)

φ mm	
1.0	50~80
1.2	50~100
1.6	100~200
2.0	100~200
2.4	150~250

## All-weld mechanical properties

	Typical
<b>0.2%YS (MPa)</b>	360
<b>TS (MPa)</b>	490
<b>EI on 4d (%)</b>	41
<b>IV -257°C (J)</b>	99

# PF-S1D/US-2209

# PREMIARC™

## Flux and wire combination for duplex stainless

<b>Features:</b>	▪ Suitable for normal duplex stainless steel (S32205, S31803, etc)
<b>Classification:</b>	AWS A5.9 ER2209 (Wire only)
<b>Type of flux:</b>	Bonded
<b>Redrying of flux:</b>	200~300°C × 1h

### Packaging data

Flux	Mesh	Can		
PF-S1D	12×65	20kg		
Volume mm		240W, 350H, 240L		
Wire	φ mm	Spool		Coil
US-2209	1.2	-	15kg	-
	1.6	10kg	15kg	-
	2.4	10kg	15kg	25kg
Volume mm		240W, 110H, 240L	285W, 110H, 285L	430W, 90H, 430L

### Composition (wire mass%)

	Typical	Guaranty <sup>a</sup>
<b>C</b>	0.02	0.03
<b>Si</b>	0.36	0.90
<b>Mn</b>	1.42	0.50~2.00
<b>P</b>	0.01	0.03
<b>S</b>	<0.01	0.03
<b>Ni</b>	8.9	7.5~9.5
<b>Cr</b>	23.3	21.5~23.5
<b>Mo</b>	3.3	2.5~3.5
<b>Cu</b>	0.16	0.75
<b>N</b>	0.15	0.08~0.20

### Composition (all-weld metal mass%)

	Typical
<b>C</b>	0.02
<b>Si</b>	0.30
<b>Mn</b>	1.66
<b>P</b>	0.02
<b>S</b>	<0.01
<b>Ni</b>	9.0
<b>Cr</b>	23.1
<b>Mo</b>	3.3
<b>Cu</b>	0.16
<b>N</b>	0.14

Note: <sup>a</sup> Single values are maximum.

### All-weld mechanical properties

	Typical
<b>0.2%YS (MPa)</b>	618
<b>TS (MPa)</b>	798
<b>EI on 4d (%)</b>	29
<b>IV -40°C (J)</b>	61

### Approvals

<b>LR</b>	S31803T, S31803M (CHEM)
<b>DNV</b>	MG
<b>BV</b>	2205TM
<b>CCS</b>	2205

**For Hardfacing**

**Welding Consumables for**

**SMAW**

**FCAW**

**GMAW**

# SMAW, FCAW, GMAW

## A guide for selecting welding consumables

Weld metal microstructure and main alloying elements determine the performances of welding consumables for hardfacing as summarized in Table 1.

Table 1 Welding consumables and their characteristics

Weld metal microstructure and alloying formula		Hv	Features
Pearlite		200-400	<ul style="list-style-type: none"> <li>▪ Good crack resistance</li> <li>▪ Good machinability</li> </ul>
Martensite		350-800	<ul style="list-style-type: none"> <li>▪ Good wear resistance</li> </ul>
13%Cr stainless steel type		350-500	<ul style="list-style-type: none"> <li>▪ Good resistance to oxidation, heat and corrosion</li> <li>▪ Good wear resistance</li> </ul>
Semi-Austenite		500-700	<ul style="list-style-type: none"> <li>▪ High toughness and good wear resistance</li> </ul>
High Mn Austenite	13%Mn	150-500	<ul style="list-style-type: none"> <li>▪ High toughness and good impact wear resistance</li> <li>▪ High work hardenability</li> </ul>
	16%Mn-16%Cr	200-400	<ul style="list-style-type: none"> <li>▪ High hardness at high temperatures</li> <li>▪ High toughness</li> </ul>
High Cr-Fe		600-800	<ul style="list-style-type: none"> <li>▪ Excellent erosion resistance</li> <li>▪ Good resistance to corrosion and heat</li> </ul>
Tungsten carbide type		800-1200	<ul style="list-style-type: none"> <li>▪ Excellent resistance to heavy abrasion</li> </ul>

Note (1) MTM: Metal-to-metal wear, ABR: Abrasion, HTW: High temp. wear, CAV: Cavitation, COR: Corrosion wear, HRT: Heat resistance, IMP: Impact wear

⊙: Excellent resistance, ○: Good resistance, △: Slightly inferior, ×: Inferior,

-: Not used for general applications

**Material to be introduced here, is for hardfacing. Please do not use the joint welding.**

	Type of wear <sup>(1)</sup>							SMAW	FCAW	GMAW
	MTM	ABR	HTW	CAV	COR	HRT	IMP			
	○	△	×	-	-	×	○	HF-240 HF-260 HF-330 HF-350	DW-H250 DW-H350	MG-250 MG-350
	○	○	△	-	×	△	△	HF-450 HF-500 HF-600 HF-650 HF-700 HF-800K	DW-H450 DW-H600 DW-H700 DW-H800	-
	○	△	○	○	○	○	△	HF-13	-	-
	○	○	△	△	△	△	△	HF-12	-	-
	×	○	×	△	×	×	◎	HF-11	DW-H11	-
	○	△	○	○	○	○	○	HF-16	DW-H16	-
	△	◎	◎	×	○	○	×	HF-30	-	-
	×	◎	×	×	×	×	×	HF-950	-	-

## Tips for better welding results

### Common

Important points in hardfacing are to obtain sufficient hardness and to minimize cracking. In order to achieve them, proper selection of welding consumables and proper welding procedures mentioned below are necessary.

1) Preparation of base metal:

Rust, oil and soil attached on the base metal may cause blowholes. Cracks in the base metal may cause cracking of the weld metal; therefore, they must be removed completely beforehand.

2) Preheat and interpass temperature:

In order to minimize cracking, control of preheat and interpass temperature is a key technique. Table 1 shows a rule of thumb for proper preheat and interpass temperatures in relation to the carbon equivalent of the base metal. In practice, size of work, type of welding consumable and method of hardfacing should be taken into consideration to determine the most appropriate temperatures.

Table 1 A rule of thumb for preheat and interpass temperature in relation to base metal carbon equivalents

Type of steel	Carbon equivalent <sup>(1)</sup>	Preheat and interpass temperature (°C)
Carbon steel and Low alloy steel	Less than 0.3	100 max.
	0.3-0.4	100 min.
	0.4-0.5	150 min.
	0.5-0.6	200 min.
	0.6-0.7	250 min.
	0.7-0.8	300 min.
	Over 0.8	350 min.
High-Mn steel (13%Mn steel)		Use no preheat and cool each weld pass with water
Austenitic stainless steel		Use no preheat and control the interpass temperature 150°C or lower
High alloy steel (e.g., High-Cr steel)		400 min.

Note (1) Carbon equivalent =  $C + Mn/6 + Si/24 + Cr/5 + Mo/4 + Ni/15$

3) Post heating:

Heating the weldment at 300-350°C for 10-30 minutes just after welding was finished is effective to prevent cold cracking. Control the temperature carefully, or the hardness of the weld will be decreased by excessive heating.



4) Postweld heat treatment:

Postweld heat treatment (PWHT) at 550-750°C is effective to prevent cold cracking and distortion in service, and to improve properties of the welds. It is important to set the PWHT conditions taking into account that the hardness of the weld is normally decreased by PWHT.

5) Underlaying:

Underlaying is effective to prevent cracking in welds where low-alloy steel having high hardenability is hardfaced or where high-hardness weld metal is deposited on carbon steel. For underlaying, mild steel type welding consumables or austenitic stainless steel type welding consumables should be used.

6) Penetration:

In hardfacing, the properties of the weld metal will considerably be affected by welding penetration into the base metal, because the chemical composition of the welding consumable is generally very different from those of the base metal. In order to use sufficiently the desired properties of the welding consumable, welding penetration must be controlled by using an appropriate welding procedure, for instance, multi-layer welding.

7) Welding distortion:

Intermittent and symmetrical welding sequences are effective to minimize welding distortion. Restraint of the work is also effective to minimize welding distortion.

### SMAW

- 1) Control the arc length as short as possible.
- 2) Use the backstep method for arc starting to prevent blowholes.
- 3) Control the weaving width less than 3-4 times the diameter of a stick electrode.
- 4) Re-dry stick electrodes before use.

### FCAW, GMAW

- 1) Control shielding gas flow rates within 20-25 l/mm for general applications. Note that poor shielding due to low flow rates and wind can cause blowholes and pits in the weld metal.
- 2) Refer to proper currents for individual wire sizes as shown in Table 2.

Table 2 Proper welding currents

Type of wire	Diameter (mm)	Polarity	Welding current (A)
DW-H series	1.2	DCEP	120-360
	1.6	DCEP	200-420
MG series	1.2	DCEP	120-320
	1.6	DCEP	200-420

Product names	Typical use & Redrying condition	Nominal hardness	Pol.	WP	Composition	C
<b>HF-240</b>	<ul style="list-style-type: none"> <li>Gears and wheels</li> <li>70~100°Cx0.5~1h</li> </ul>	Hv 240	AC DCEP	1F 1G 3G uphill 4G	Ty	0.09
<b>HF-260</b>	<ul style="list-style-type: none"> <li>Shafts, crane wheels and couplings</li> <li>300~350°Cx0.5~1h</li> </ul>	Hv 260	AC DCEP	1F 1G 3G uphill 4G	Ty	0.17
<b>HF-330</b>	<ul style="list-style-type: none"> <li>Keys and clutch lugs</li> <li>70~100°Cx0.5~1h</li> </ul>	Hv 330	AC DCEP	1F 1G 3G uphill 4G	Ty	0.10
<b>HF-350</b>	<ul style="list-style-type: none"> <li>Upper rollers and sprockets of bulldozers</li> <li>300~350°Cx0.5~1h</li> </ul>	Hv 350	AC DCEP	1F 1G 3G uphill 4G	Ty	0.25

Note: Welding tests are as per Kobe Steel's Standard. Ty: Typical (polarity: AC)

**Identification color**

Product names	1st	2nd
<b>HF-240</b>	Red	White
<b>HF-260</b>	Red	Green
<b>HF-330</b>	Red	Purple
<b>HF-350</b>	Orange	Green

Please do not use the joint welding.

**PREMIARC™**

(overlay weld metal mass%)			Weld metal hardness		
Si	Mn	Cr	PWHT	Hv	Pre. H & IPT °C
0.58	0.58	0.81	AW	240	150min.
			900°C, OQ	350	
0.69	1.81	-	AW	271	150min.
			900°C, OQ	395	
0.69	0.86	2.29	AW	340	150min.
			-	-	
0.49	1.38	1.16	AW	366	150min.
			850°C, OQ	510	

**Packaging data**

φ mm	2.6	3.2	4.0	5.0	6.0
<b>HF-240</b>	-	350	400	400	450
<b>HF-260</b>	300	350	400	400	450
<b>HF-330</b>	-	350	400	400	450
<b>HF-350</b>	300	350	400	400	450
<b>carton mm</b>	270W, 90H, 330L	170W, 120H, 380L	170W, 120H, 430L	170W, 120H, 430L	170W, 110H, 480L

Product names	Typical use & Redrying condition	Nominal hardness	Pol.	WP	Composition	
					Ty	C
<b>HF-450</b>	<ul style="list-style-type: none"> <li>Idlers, rollers and truck links of bulldozers</li> <li>300~350°Cx0.5~1h</li> </ul>	Hv 450	AC DCEP	1F 1G	Ty	0.20
<b>HF-500</b>	<ul style="list-style-type: none"> <li>Idlers and truck links of bulldozers</li> <li>300~350°Cx0.5~1h</li> </ul>	Hv 500	AC DCEP	1F 1G	Ty	0.45
<b>HF-600</b>	<ul style="list-style-type: none"> <li>Lower rollers and bucket edges</li> <li>300~350°Cx0.5~1h</li> </ul>	Hv 600	AC DCEP	1F 1G	Ty	0.48
<b>HF-650</b>	<ul style="list-style-type: none"> <li>Tamping dies and mixer blades</li> <li>300~350°Cx0.5~1h</li> </ul>	Hv 650	AC DCEP	1F 1G	Ty	0.67

Note: Welding tests are as per Kobe Steel's Standard. Ty: Typical (polarity: AC)

**Identification color**

Product names	1st	2nd
<b>HF-450</b>	Red	Pink
<b>HF-500</b>	Orange	Blue white
<b>HF-600</b>	Red	Red
<b>HF-650</b>	Red	Orange

Please do not use the joint welding.

**PREMIARC™**

(overlay weld metal mass%)						Weld metal hardness		
Si	Mn	Cr	Mo	V	W	PWHT (°C×h)	Hv	Pre. H & IPT °C
						AW	456	
1.30	0.31	2.54	0.60	0.23	-	-----		150min.
						550x6	443	
1.37	0.91	-	0.98	0.28	-	AW	517	150min.
0.77	2.58	2.50	-	-	-	AW	595	200min.
						AW	634	
0.90	0.87	4.91	1.17	0.55	1.42	-----		200min.
						600x1, AC	580	

### Packaging data

φ mm	2.6	3.2	4.0	5.0	6.0
<b>HF-450</b>	-	-	400	400	450
<b>HF-500</b>	-	350	400	400	450
<b>HF-600</b>	300	350	400	400	450
<b>HF-650</b>	300	350	400	400	450
<b>carton mm</b>	270W, 100H, 330L	170W, 130H, 380L	170W, 120H, 430L	170W, 125H, 430L	170W, 115H, 480L

Product names	Typical use & Redrying condition	Nominal hardness	Pol.	WP	Composition	
					Ty	C
<b>HF-700</b>	<ul style="list-style-type: none"> <li>Cutter knives and casings</li> <li>300~350°Cx0.5~1h</li> </ul>	Hv 700	AC DCEP	1F 1G	Ty	0.62
<b>HF-800K</b>	<ul style="list-style-type: none"> <li>Cutter knives and casings</li> <li>300~350°Cx0.5~1h</li> </ul>	Hv 800	AC DCEP	1F 1G	Ty	0.80
<b>HF-950</b>	<ul style="list-style-type: none"> <li>Shovel teeth and cutter knives</li> <li>150~200°Cx0.5~1h</li> </ul>	Hv 950	AC DCEP	1F 1G	Ty	3.5

Note: Welding tests are as per Kobe Steel's Standard. Ty: Typical (polarity: AC)

### Identification color

Product names	1st	2nd
<b>HF-700</b>	Orange	Orange
<b>HF-800K</b>	Orange	Yellow
<b>HF-950</b>	Orange	-

Please do not use the joint welding.

**PREMIARC™**

(overlay weld metal mass%)						Weld metal hardness		
Si	Mn	Cr	Mo	W	B	PWHT (°C×h)	Hv	Pre. H & IPT °C
0.80	0.78	5.12	2.21	-	-	AW	654	200min.
						600x1, AC	485	
1.65	1.24	3.82	-	2.42	0.29	AW	736	200min.
						600x1, AC	535	
0.1	2.6	-	-	26	-	AW	930	300min.

#### Packaging data

φ mm	3.2	4.0	5.0	6.0
<b>HF-700</b>	-	400	400	450
<b>HF-800K</b>	350	400	400	450
<b>HF-950</b>	-	400	400	-
<b>carton mm</b>	170W, 120H, 380L	170W, 115H, 430L	170W, 120H, 430L	170W, 120H, 480L

Product names	Typical use & Redrying condition	Nominal hardness	Pol.	WP	Composition	
					Ty	C
HF-11	<ul style="list-style-type: none"> <li>Crusher hammers and crusher jaws</li> <li>150~200°Cx0.5~1h</li> </ul>	Hv 250	AC DCEP	1F 1G	Ty	0.82
HF-12	<ul style="list-style-type: none"> <li>Ripper teeth, impellers and breakers</li> <li>300~350°Cx0.5~1h</li> </ul>	Hv 500	AC DCEP	1F 1G	Ty	0.72
HF-13	<ul style="list-style-type: none"> <li>Valve seats and agitator propellers</li> <li>300~350°Cx0.5~1h</li> </ul>	Hv 450	AC DCEP	1F 1G	Ty	0.13
HF-16	<ul style="list-style-type: none"> <li>Hot shears and hot dies</li> <li>150~200°Cx0.5~1h</li> </ul>	Hv 300	AC DCEP	1F 1G	Ty	0.71
HF-30	<ul style="list-style-type: none"> <li>Crusher rotors and liners</li> <li>300~350°Cx0.5~1h</li> </ul>	Hv 700	AC DCEP	1F 1G	Ty	5.00

Note: Welding tests are as per Kobe Steel's Standard. Ty: Typical (polarity: AC)

### Identification color

Product names	1st	2nd
HF-11	Red	Black
HF-12	Red	Brown
HF-13	Red	Blue white
HF-16	Orange	Brown
HF-30	Red	Silver



Please do not use the joint welding.

**PREMIARC™**

(overlay weld metal mass%)						Weld metal hardness	
Si	Mn	Cr	Mo	V	Ni	PWHT (°C×h)	Hv
0.39	13.88	-	-	-	-	AW	266
0.89	1.17	7.30	1.12	-	-	AW	532
						500x2	630
0.50	0.74	12.97	0.97	-	0.99	AW	420
						750x1	260
0.48	14.59	15.33	1.85	0.42	2.20	AW	306
0.42	1.23	30.5	-	-	-	AW	770

### Packaging data

φ mm	2.6	3.2	4.0	5.0	6.0
<b>HF-11</b>	-	350	400	400	450
<b>HF-12</b>	300	350	400	400	450
<b>HF-13</b>	-	350	400	400	-
<b>HF-16</b>	-	300	350	350	-
<b>HF-30</b>	-	-	400	450	-
<b>carton mm</b>	270W, 100H, 330L	170W, 125H, 380L or 330L	170W, 120H, 430L or 380L	170W, 120H, 430L or 380L	170W, 110H, 480L

Product names	Typical use	Nominal hardness	SG	WP
DW-H250	▪ Metal-to-metal wear parts and underlaying for hardfacing and repair	Hv 250	CO <sub>2</sub>	1F 1G 2F
DW-H350	▪ Metal-to-metal wear and light abrasion parts	Hv 350	CO <sub>2</sub>	1F 1G 2F
DW-H450	▪ Metal-to-metal wear and abrasion parts	Hv 450	CO <sub>2</sub>	1F 1G 2F
DW-H600	▪ Abrasion parts	Hv 600	CO <sub>2</sub>	1F 1G 2F
DW-H700	▪ Abrasion parts	Hv 700	CO <sub>2</sub>	1F 1G 2F
DW-H800	▪ Heavy abrasion parts ▪ Metal type flux cored wire	Hv 800	CO <sub>2</sub>	1F 1G 2F

Note: Polarity: DCEP, Welding tests are as per Kobe Steel's Standard. Ty: Typical

**Packaging data**

φ mm	DW-H250	DW-H350	DW-H450	DW-H600	DW-H700	DW-H800
1.2	20kg	20kg	20kg	20kg	20kg	20kg
1.6	20kg	20kg	20kg	20kg	20kg	20kg
<b>Volume mm</b>	300W, 110H, 300L					

Please do not use the joint welding.

**PREMIARC™**

	Composition (overlay weld metal mass%)								Weld metal hardness		
	C	Si	Mn	Cr	Mo	V	W	B	PWHT (°C×h)	Hv	Pre. H & IPT °C
Ty	0.09	0.49	1.30	1.02	0.40	-	-	-	AW	269	150min.
									600x2	270	
Ty	0.13	0.64	1.70	0.48	0.53	-	-	-	AW	370	150min.
									600x2	297	
Ty	0.15	0.57	1.40	3.70	0.47	0.25	-	-	AW	431	150min.
									600x2	384	
Ty	0.45	0.48	0.97	4.31	0.51	-	-	-	AW	574	200min.
									600x2	398	
Ty	0.57	0.73	1.05	5.40	1.01	0.54	1.21	-	AW	673	250min.
									600x2	605	
Ty	1.10	0.68	1.83	4.22	-	-	2.26	0.54	AW	772	250min.
									600x2	612	

<b>Product names</b>	<b>Typical use</b>	<b>Nominal hardness</b>	<b>SG</b>	<b>WP</b>
<b>DW-H11</b>	<ul style="list-style-type: none"> <li>▪ Abrasion accompanied by heavy impact parts and repair welding of 13%-Mn cast steel</li> <li>▪ Metal type flux cored wire</li> </ul>	Hv 250	Ar-CO <sub>2</sub>	1F 1G 2F
<b>DW-H16</b>	<ul style="list-style-type: none"> <li>▪ High temperature wear, impact wear and cavitation parts such as hot shear bytes, hot saws, and hydraulic power water turbines</li> <li>▪ Metal type flux cored wire</li> </ul>	Hv 300	Ar-CO <sub>2</sub>	1F 1G 2F

Note: Polarity: DCEP, Welding tests are as per Kobe Steel’s Standard. Ty: Typical

**Packaging data**

<b>φ mm</b>	<b>DW-H11</b>	<b>DW-H16</b>
1.2	-	12.5kg
1.6	12.5kg	-
<b>Volume mm</b>	300W, 110H, 300L	

Please do not use the joint welding.

**PREMIARC™**

	Composition (overlay weld metal mass%)							Weld metal hardness		
	C	Si	Mn	Cr	Mo	V	B	PWHT	Hv	Pre. H & IPT °C
Ty	0.84	0.68	14.17	-	-	-	-	AW	233	-
Ty	0.60	0.51	16.76	16.21	1.49	0.49	-	AW	278	150min.



**For Cast Iron**

**Welding Consumables for**

---

**SMAW**

## A guide for selecting welding consumables

Table 1 shows stick electrodes for shielded metal arc welding of cast irons in conjunction with weldability, usability, color matching, and machinability.

Table 1 Welding consumables for cast irons <sup>(1)</sup>

Product names	Preheat temperature (°C)	Wettability with base metal	Color matching with base metal	Joint efficiency	X-ray soundness	Machinability of weld metal	Machinability of HAZ
CI-A1	100-300	○	△	◎	○	◎	◎
CI-A2	150-350	◎	△	◎	○	◎	○
CI-A3	350-400	◎	◎	○	○	△	△

Note (1) ◎: Good, ○: Better, △: Inferior

## Tips for better welding results

### 1) Preparation for base metal:

- (1) When cast irons have impregnated oil, the base metal must be heated at 400°C to burn off the oil before welding. Other contaminants should also be removed off before welding.
- (2) To repair a defect, it must be removed completely by machining or grinding (arc air gouging is not suitable for cast irons) before welding. The welding groove should have a round bottom for better fusion. Where a crack defect seems to be propagated by machining or grinding, make stop-holes at both ends of the crack.

### 2) Welding procedure:

- (1) The most appropriate preheating temperature depends on the size and thickness of the work; however, Table 1 can be a rule of thumb.
- (2) Stringer welding with the maximum bead length of about 50 mm is recommended to prevent overheat, distortion and cracking.
- (3) Peening is needed to minimize residual stresses. Just after one bead was laid, it must be peened with a hammer to the extent that the ripple of the bead disappears.
- (4) Comparatively small conical groove should be welded in the spiral sequence from the bottom of the groove to the surface of the base metal. Backstep, symmetrical or intermittent sequence is recommended for a long welding line to prevent cracking. The buttering method, in which the surface of the groove is clad first and the filling passes are laid later, is recommended for a deep groove.





# SMAW

Product names	Typical use & Redrying condition	AWS Class.	Pol.	WP	C	Si	
CI-A1	<ul style="list-style-type: none"> <li>Repairing and joining various kinds of cast irons</li> <li>70~100°Cx0.5~1h</li> </ul>	A5.15 ENi-CI	AC DCEP	F	Ty	1.0	0.1
					Gt <sup>a</sup>	2.0	4.0
CI-A2	<ul style="list-style-type: none"> <li>Repairing and joining various kinds of cast irons</li> <li>70~100°Cx0.5~1h</li> </ul>	A5.15 ENiFe-CI	AC DCEP	F	Ty	1.1	0.3
					Gt <sup>a</sup>	2.0	4.0
CI-A3	<ul style="list-style-type: none"> <li>Repairing and joining various kinds of cast irons</li> <li>300~350°Cx0.5~1h</li> </ul>	-	AC DCEP	F	Ty	0.04	0.50
					Gt <sup>a</sup>	0.15	1.00

Note: <sup>a</sup> Single values are maximum. Ty: Typical (polarity: AC), Gt: Guaranty

## Identification color

Product names	1st	2nd
CI-A1	Gold	Red
CI-A2	Gold	Pink
CI-A3	Black	Orange

## Composition (all-weld metal mass%)

## All-weld mechanical properties

Mn	P	S	Ni	Fe	Cu	Al	TS (MPa)	EI on 4d (%)
0.6	<0.01	<0.01	Bal.	1.7	<0.1	<0.1	480	-
2.5	-	0.03	85min.	8.0	2.5	1.0	-	-
2.0	<0.01	<0.01	55	Bal.	<0.1	<0.1	520	-
2.5	-	0.03	45~60	Bal.	2.5	1.0	-	-
0.48	0.01	<0.01	-	Bal.	-	-	490	33
0.80	0.04	0.04	-	Bal.	-	-	-	-

## Packaging data

φ mm	2.6	3.2	4.0
<b>CI-A1</b>	-	350	350
<b>CI-A2</b>	300	300	350
<b>CI-A3</b>	300	350	-
<b>carton mm</b>	250W, 135H, 450L	250W, 120H, 440L	240W, 85H, 440L
			170W, 115H, 430L



# **For 9%Ni Steel and Nickel-Based Alloy**

## **Welding Consumables for**

**SMAW**

**FCAW**

**GMAW**

**GTAW**

**SAW**

Inconel, Incoloy and Monel are trademarks of Special Metals Corporation.  
Hastelloy is a trademark of Haynes International.

# SMAW, FCAW, GMAW, GTAW, SAW

## For 9%Ni Steel

For welding of 9%Ni steel, Ni-base alloys such as Ni-Cr alloy (e.g., Inconel) and Ni-Mo alloy (e.g., Hastelloy) welding consumables are commonly used to obtain sufficient notch toughness at cryogenic temperatures. 9%Ni steel is used for storage tanks for liquefied natural gas (LNG), liquefied oxygen and liquefied nitrogen, and LNG carriers. In the construction of such cryogenic temperature service equipment, automatic gas tungsten arc welding and submerged arc welding are often used to ensure consistent weld quality, as shown in Fig. 1.

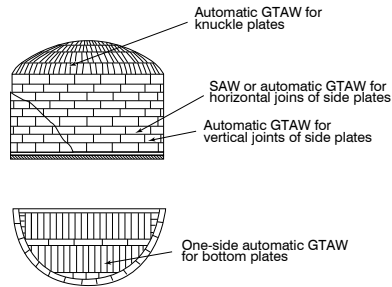

Fig. 1 Typical applications of automatic welding processes for a LNG storage tank

## Tips for better welding results

### Common

- (1) Remove scale, rust, and other dirt from welding grooves beforehand by grinding or other appropriate means.
- (2) Use no preheat and control interpass temperatures at 150°C or lower.
- (3) Minimize welding currents and welding speeds to prevent hot cracking.
- (4) Use no magnetic power crane because 9%Ni steel is likely to be magnetized.

### SMAW

- (1) Re-dry stick electrodes by 200-250°C for 30-60 minutes before use.
- (2) Keep the arc length as short as possible.

### FCAW, GMAW

- (1) Use Ar-CO<sub>2</sub> mixtures with 20-25%CO<sub>2</sub> for shielding gas. The gas flow rates should be 20-25 l/min.
- (2) Refer to Pages 211 and 213 of the stainless steel article about power source, wire extension, protection against wind and welding fumes, and storage of welding wires.

### GTAW

- (1) Use multi-pass welding because the use of single-pass welding may cause a decrease of weld metal strength affected by the dilution from the base metal.

### SAW

- (1) Re-dry fluxes by 200-300°C for 1 hour before use.
- (2) Use multi-pass welding because the use of single-pass welding may cause a decrease of weld metal strength affected by the dilution from the base metal.

## For Ni-base alloy

---

Typical Ni-base alloys for welding are Ni-Cu alloy (e.g. Monel), Ni-Cr alloy (e.g. Inconel) and Ni-Fe-Cr alloys (e.g. Incoloy). Ni-base welding consumables are used for joining these Ni-base alloys and dissimilar-metal joints consisting of Ni-base alloy and low alloy steel, stainless steel, and low alloy steel.

### Tips for better welding results

---

#### SMAW

- (1) Use proper welding currents because the use of an excessive welding current causes electrode-burn and thereby usability and weld metal properties can be deteriorated.
- (2) Use no preheating for welding matching Ni-base alloys. Control interpass temperatures at 150°C or lower.
- (3) Use the backstep technique when an arc is struck in the welding groove, or strike an arc on a piece of metal outside the groove to prevent the occurrence of blowholes at the arc starting area of a bead.
- (4) Keep the arc length as short as possible.
- (5) Use flat-position welding as much as possible because vertical or overhead welding requires higher welding skill.
- (6) Minimize welding currents and speeds to prevent hot cracking.

#### FCAW

- (1) Use Ar-CO<sub>2</sub> mixtures with 20-25%CO<sub>2</sub> for shielding gas. The gas flow rates should be 20-25 l/min.
- (2) Refer to Page 211 of the stainless steel article about power source, wire extension, protection against wind and welding fumes, and storage of welding wires.

#### GMAW

- (1) Pulsed arc welding with the spray droplet transfer mode using low currents is most appropriate, although conventional gas metal arc welding power sources can be used. DC-EP polarity is suitable.
- (2) Argon gas shielding with gas flow rates in the 25-30 l/min range is suitable. Ar-He mixture gases are also suitable.
- (3) Use no preheating and control interpass temperatures at 150°C or lower.
- (4) Minimize welding currents and speeds to prevent hot cracking.

#### GTAW

- (1) Use DCEN polarity.
- (2) Argon gas shielding with gas flow rates in the 10-15 l/min range is suitable where welding currents are within 100-200A. In one-side welding, back shielding is needed to avoid oxidation of the back side bead.
- (3) Control the arc length at approximately 2-3 mm because the use of an excessive arc length may cause lack of shielding, thereby causing blowholes.
- (4) Use no preheating and control interpass temperatures at 150°C or lower.
- (5) Minimize welding currents and speeds to prevent hot cracking.

# SMAW, FCAW, GMAW, GTAW

## How to select the proper welding consumable for dissimilar metal joints

Recommended welding consumables and preheat temperatures are shown in Table 1. <sup>(1)</sup> <sup>(2)</sup>

Table 1 Recommended welding consumables

Base metal: A Base metal: B		Carbon steel and low alloy steel	Nickel and		
			Inconel	Incoloy	
Stainless steel	Austenitic	NC-39, NC-39L NC-39MoL NI-C70A <sup>(3)</sup>  100~200°C	NI-C70A  —	NI-C70A  —	
	Martensitic	NC-39, NC-39L CR-43Cb <sup>(4)</sup> NI-C70A <sup>(3)</sup>  200~400°C	NI-C70A  100~300°C	NI-C70A  100~300°C	
	Ferritic	NC-39, NC-39L CR-43Cb <sup>(4)</sup> NI-C70A <sup>(3)</sup>  100~300°C	NI-C70A  100~200°C	NI-C70A  100~200°C	
Nickel and nickel alloy	Nickel	NI-C70A  100~200°C	NI-C70A  —	NI-C70A  —	
	Monel	NI-C70A  100~200°C	NI-C70A  —	NI-C70A  —	
	Incoloy	NI-C70A  100~200°C	NI-C70A  —		
	Inconel	NI-C70A  100~200°C			



nickel alloy		Stainless steel	
Monel	Nickel	Ferritic	Martensitic
NI-C70A —	NI-C70A —	NC-39, NC-39L NI-C70A <sup>(3)</sup> 100~200°C	NC-39, NC-39L NI-C70A <sup>(3)</sup> 100~300°C
NI-C70A 100~300°C	NI-C70A 100~300°C	NC-39 CR-43Cb <sup>(5)</sup> CR-40Cb <sup>(5)</sup> 200~400°C	
NI-C70A 100~200°C	NI-C70A 100~200°C		
NI-C70A —			

Note: (1) This table shows only stick electrodes for SMAW. Other welding consumables having the similar chemical composition for GTAW, GMAW, and FCAW can also be used. Instead of NI-C70A, NI-C703D can also be used.

- (2) The preheat temperature in this table is a rough guide. In a case where the welding joint consists of thick plates and is restrained to a great extent, a higher temperature may be necessary. Even when preheat temperature is given for particular dissimilar metal joints, austenitic stainless steel, nickel, and nickel alloy need not be preheated, and the counterpart base metals such as carbon steel, martensitic stainless steel, and ferritic stainless steel should be preheated sufficiently. In addition, for a dissimilar metal joint consisting of carbon steel (Base metal: A) and austenitic stainless steel, nickel, or nickel alloy (Base metal: B), both base metals need not be preheated.
- (3) In a case where the weld is used at about 400°C or higher or under thermal cycles, NI-C70A should be selected.
- (4) In a case where Ni is restricted in a special service environment, CR-43Cb should be used.
- (5) In a case where Ni is restricted in a special service environment, CR-43Cb or CR-40Cb should be selected.

## Stick electrode

**Features:** ▪ Suitable for Inconel and dissimilar-metal joints such as Inconel to low alloy steel, and stainless steel to low alloy steel

**Classification:** AWS A5.11 ENiCrFe-1

**Redrying Conditions:** 200~250°Cx0.5~1h

**Identification color:** 1st Silver, 2nd Green

**Polarity:** AC

## Welding Positions:

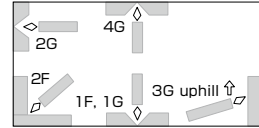

## Packaging data

φ mm	Length mm	kg/pack	kg/carton	g/piece	carton mm
3.2	300	2	20	29	300W, 100H, 330L
4.0	350	5	20	51	175W, 130H, 380L
5.0	350	5	20	80	175W, 130H, 380L

## Composition (all-weld metal mass%)

	Typical	Guaranty <sup>a</sup>
<b>C</b>	0.04	0.08
<b>Si</b>	0.20	0.75
<b>Mn</b>	3.0	3.5
<b>P</b>	0.01	0.03
<b>S</b>	0.003	0.015
<b>Ni</b>	72.0	62.0min.
<b>Cr</b>	14.7	13.0~17.0
<b>Cu</b>	0.01	0.50
<b>Nb+Ta</b>	1.8	1.5~4.0
<b>Fe</b>	7.9	11.0

Note: <sup>a</sup> Single values are maximum.

## Welding parameters (A)

φ mm	1F, 1G, 2F, 2G	3G uphill, 4G
3.2	70~115	65~110
4.0	95~145	85~135
5.0	115~170	-

## All-weld mechanical properties

	Typical	Guaranty
<b>0.2%YS (MPa)</b>	380	-
<b>TS (MPa)</b>	610	552min.
<b>EI on 4d (%)</b>	44	30min.
<b>IV -196°C (J)</b>	93	-

## Stick electrode

**Features:** • Suitable for Inconel and dissimilar-metal joints such as Inconel to low alloy steel, and stainless steel to low alloy steel

**Classification:** AWS A5.11 ENiCrFe-3

**Redrying Conditions:** 200~250°Cx0.5~1h

**Identification color:** 1st Silver, 2nd Blue

**Polarity:** DCEP

## Welding Positions:

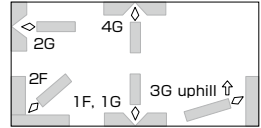

## Packaging data

φ mm	Length mm	kg/pack	kg/carton	g/piece	carton mm
2.6	250	2	20	16	300W, 130H, 290L
3.2	300	2	20	31	300W, 100H, 330L
4.0	350	5	20	54	175W, 130H, 380L
5.0	350	5	20	85	175W, 130H, 380L

## Composition (all-weld metal mass%)

	Typical	Guaranty <sup>a</sup>
<b>C</b>	0.06	0.10
<b>Si</b>	0.3	1.0
<b>Mn</b>	6.5	5.0~9.5
<b>P</b>	0.004	0.03
<b>S</b>	0.003	0.015
<b>Ni</b>	69.4	59.0min.
<b>Cr</b>	13.2	13.0~17.0
<b>Cu</b>	0.03	0.50
<b>Nb+Ta</b>	2.0	1.0~2.5
<b>Fe</b>	7.90	10.00
<b>Ti</b>	<0.1	1.0
<b>Co</b>	0.03	0.12

Note: <sup>a</sup> Single values are maximum.

## Welding parameters (A)

φ mm	1F, 1G, 2F, 2G	3G uphill, 4G
2.6	50~80	45~75
3.2	80~110	80~105
4.0	90~140	90~120
5.0	140~180	-

## All-weld mechanical properties

	Typical	Guaranty
<b>0.2%YS (MPa)</b>	360	-
<b>TS (MPa)</b>	620	552min.
<b>EI on 4d (%)</b>	45	30min.
<b>IV -196°C (J)</b>	110	-

## Stick electrode

**Features:** • Suitable for 9% Ni steel  
**Classification:** AWS A5.11 ENiCrFe-9  
**Redrying Conditions:** 200~250°Cx0.5~1h  
**Identification color:** 1st Silver grey, 2nd Pink  
**Polarity:** AC

## Welding Positions:

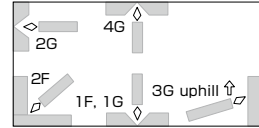

## Packaging data

φ mm	Length mm	kg/pack	kg/carton	g/piece	carton mm
3.2	300	2	20	29	300W, 100H, 330L
4.0	350	5	20	53	175W, 130H, 380L
5.0	350	5	20	82	175W, 130H, 380L

## Composition (all-weld metal mass%)

	Typical	Guaranty <sup>a</sup>
<b>C</b>	0.08	0.15
<b>Si</b>	0.26	0.75
<b>Mn</b>	2.4	1.0~4.5
<b>P</b>	0.01	0.02
<b>S</b>	<0.01	0.015
<b>Ni</b>	66.6	55.0min.
<b>Cr</b>	13.8	12.0~17.0
<b>Mo</b>	3.9	2.5~5.5
<b>Cu</b>	0.02	0.50
<b>Nb+Ta</b>	1.5	0.5~3.0
<b>Fe</b>	10.3	12.00
<b>W</b>	0.6	1.5

Note: <sup>a</sup>Single values are maximum.

## Welding parameters (A)

φ mm	1F, 1G, 2F, 2G	3G uphill, 4G
3.2	70~115	65~110
4.0	95~145	85~135
5.0	115~180	-

## All-weld mechanical properties

	Typical	Guaranty
<b>0.2%YS (MPa)</b>	450	-
<b>TS (MPa)</b>	703	655min.
<b>EI on 4d (%)</b>	43	25min.
<b>IV -196°C (J)</b>	63	-

## Approvals

<b>ABS</b>	MG (AWS A5.11 ENiCrFe-9)
<b>LR</b>	5Nim,9Nim
<b>DNV</b>	MG (VL9Ni), H10
<b>BV</b>	UP (ENiCrFe-9)
<b>NK</b>	KMWL92
<b>CCS</b>	9Ni
<b>KR</b>	L91

Note: AC

## Stick electrode

**Features:** • Suitable for 9% Ni steel  
**Classification:** AWS A5.11 ENiMo-8  
**Redrying Conditions:** 200~250°Cx0.5~1h  
**Identification color:** 1st Yellow, 2nd Green  
**Polarity:** AC

## Welding Positions:

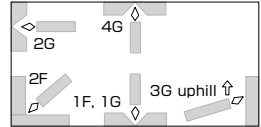

## Packaging data

φ mm	Length mm	kg/pack	kg/carton	g/piece	carton mm
3.2	300	2	20	30	300W, 100H, 330L
4.0	350	5	20	55	175W, 130H, 380L
5.0	350	5	20	84	175W, 130H, 380L

## Composition (all-weld metal mass%)

	Typical	Guaranty <sup>a</sup>
<b>C</b>	0.02	0.10
<b>Si</b>	0.47	0.75
<b>Mn</b>	0.3	1.5
<b>P</b>	<0.01	0.02
<b>S</b>	0.001	0.015
<b>Ni</b>	68.7	60.0min.
<b>Cr</b>	1.8	0.5~3.5
<b>Mo</b>	18.4	17.0~20.0
<b>Cu</b>	0.01	0.50
<b>Fe</b>	7.0	10.0
<b>W</b>	2.9	2.0~4.0

Note: <sup>a</sup>Single values are maximum.

## Welding parameters (A)

φ mm	1F, 1G, 2F, 2G	3G uphill, 4G
3.2	70~115	65~110
4.0	100~145	85~135
5.0	130~200	-

## All-weld mechanical properties

	Typical	Guaranty
<b>0.2%YS (MPa)</b>	473	-
<b>TS (MPa)</b>	750	655min.
<b>El on 4d (%)</b>	46	25min.
<b>IV -196°C (J)</b>	92	-

## Approvals

<b>NK</b>	KMWL92, KMWL92-YP420M-TS690M
-----------	---------------------------------

Note: AC

## Flux cored wire

**Features:** • Suitable for Ni-based alloy of 600 and dissimilar-metal joints such as Ni-based alloy to low alloy steel and stainless steel to low alloy steel

**Classification:** AWS A5.34 ENiCr3T1-4

**Shielding gas:** Ar-CO<sub>2</sub>

**Polarity:** DCEP

## Welding Positions:

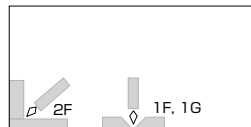

## Packaging data

φ mm	Spool
1.2	12.5kg
<b>Volume mm</b>	295W, 110H, 295L

## Composition (all-weld metal mass%)

	Typical	Guaranty <sup>a</sup>
<b>C</b>	0.02	0.10
<b>Si</b>	0.20	0.50
<b>Mn</b>	3.0	2.5~3.5
<b>P</b>	<0.01	0.03
<b>S</b>	0.003	0.015
<b>Ni</b>	71.4	67.0min.
<b>Cr</b>	21.1	18.0~22.0
<b>Cu</b>	<0.01	0.50
<b>Fe</b>	0.8	3.0
<b>Nb+Ta</b>	2.5	2.0~3.0
<b>Ti</b>	0.17	0.75

Note: <sup>a</sup> Single values are maximum.

## Welding parameters (A)

φ mm	1F, 1G, 2F
1.2	150~220

## All-weld mechanical properties

	Typical	Guaranty
<b>0.2%YS (MPa)</b>	380	-
<b>TS (MPa)</b>	650	552min.
<b>EI on 4d (%)</b>	46	25min.
<b>IV 0°C (J)</b>	128	-

# DW-N625

## Flux cored wire

**Features:** ▪ Suitable for Ni-based alloy of 625, dissimilar-metal joints and overlaying

**Classification:** AWS A5.34 ENiCrMo3T1-1/4

**Shielding gas:** Ar-CO<sub>2</sub>, CO<sub>2</sub>

**Polarity:** DCEP

## Welding Positions:

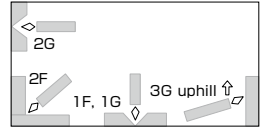

## Packaging data

φ mm	Spool
1.2	12.5kg
Volume mm	295W, 110H, 295L

## Composition (all-weld metal mass%)

	Typical (Ar-CO <sub>2</sub> )	Guaranty <sup>a</sup>
<b>C</b>	0.03	0.10
<b>Si</b>	0.37	0.50
<b>Mn</b>	0.28	0.50
<b>P</b>	0.01	0.02
<b>S</b>	0.003	0.015
<b>Ni</b>	63.3	58.0min.
<b>Cr</b>	21.6	20.0~23.0
<b>Mo</b>	8.6	8.0~10.0
<b>Cu</b>	0.01	0.50
<b>Fe</b>	1.8	5.0
<b>Nb+Ta</b>	3.57	3.15~4.15
<b>Ti</b>	0.11	0.40

Note: <sup>a</sup> Single values are maximum.

## Welding parameters (A)

φ mm	1F, 1G, 2F, 2G	3G uphill
1.2	150~210	130~180

## All-weld mechanical properties

	Typical	Guaranty
<b>0.2%YS (MPa)</b>	472	-
<b>TS (MPa)</b>	752	690min.
<b>EI on 4d (%)</b>	38	25min.
<b>IV 0°C (J)</b>	67	-

## Approvals

ABS BV	MG UP (ENiCrMo3T1-4)
-----------	-------------------------

Note: Ar-CO<sub>2</sub>

## Flux cored wire

**Features:** • Suitable for Ni-based alloy of C276 and super austenitic stainless steel

**Classification:** AWS A5.34 ENiCrMo4T1-4

**Shielding gas:** Ar-CO<sub>2</sub>

**Polarity:** DCEP

## Welding Positions:

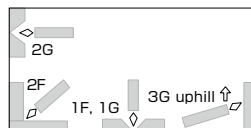

## Packaging data

φ mm	Spool	
1.2	12.5kg	12.7kg
Volume mm	295W, 110H, 295L	

## Composition (all-weld metal mass%)

	Typical	Guaranty <sup>a</sup>
<b>C</b>	0.02	0.02
<b>Si</b>	0.2	0.2
<b>Mn</b>	0.6	1.0
<b>P</b>	0.01	0.03
<b>S</b>	<0.01	0.03
<b>Ni</b>	57.3	Bal.
<b>Cr</b>	14.8	14.5~16.5
<b>Mo</b>	16.9	15.0~17.0
<b>Cu</b>	0.07	0.50
<b>Fe</b>	5.6	4.0~7.0
<b>W</b>	3.7	3.0~4.5
<b>Co</b>	0.3	2.5
<b>V</b>	0.06	0.35

Note: <sup>a</sup>Single values are maximum.

## Welding parameters (A)

φ mm	1F, 1G, 2F
1.2	150~220

## All-weld mechanical properties

	Typical	Guaranty
<b>0.2%YS (MPa)</b>	466	-
<b>TS (MPa)</b>	719	690min.
<b>EI on 4d (%)</b>	46	25min.
<b>IV 0°C (J)</b>	63	-



# DW-N709SP

## Flux cored wire

- Features:**
- Hastelloy type consumable
  - Suitable for 9%Ni steel

**Classification:** AWS A5.34 ENiMo13T1-1/4

**Shielding gas:** CO<sub>2</sub> or Ar-CO<sub>2</sub>

**Polarity:** DCEP

### Welding Positions:

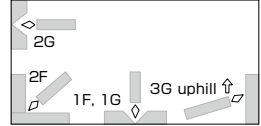

## Packaging data

φ mm	Spool
1.2	12.5kg
Volume mm	295W, 110H, 295L

## Composition (all-weld metal mass%)

	Typical (Ar-CO <sub>2</sub> )	Guaranty <sup>a</sup>
<b>C</b>	0.01	0.10
<b>Si</b>	0.12	0.75
<b>Mn</b>	2.4	2.0~3.0
<b>P</b>	0.012	0.020
<b>S</b>	0.003	0.015
<b>Ni</b>	63.4	58.0min.
<b>Cr</b>	6.7	4.0~8.0
<b>Mo</b>	17.5	16.0~19.0
<b>Cu</b>	<0.1	0.5
<b>Fe</b>	6.8	10.0
<b>W</b>	2.6	2.0~4.0

Note: <sup>a</sup>Single values are maximum, except Ni.

## Welding parameters (A)

φ mm	1F, 1G, 2F	2G	3G uphill
1.2	180~250	150~210	140~180

## All-weld mechanical properties

	Typical (Ar-CO <sub>2</sub> )	Guaranty
<b>0.2%YS (MPa)</b>	440	-
<b>TS (MPa)</b>	712	690min.
<b>EI on 4d (%)</b>	43	25min.
<b>IV -196°C (J)</b>	77	-

## Approvals

<b>ABS</b>	MG
<b>LR</b>	9NiS
<b>DNV</b>	MS (9Ni)
<b>BV</b>	ISO 12513 T Ni 1013 P M21 2
<b>NK</b>	KMWL92G (C), KMWL92G (C) -YP430M-TS690M(CO <sub>2</sub> )
<b>CCS</b>	9Ni (Ar-CO <sub>2</sub> )

**Solid wire**

- Features:**
- Inconel 82 type filler wire
  - Suitable for Inconel, Incoloy, dissimilar-metal joints and overlaying on carbon steel

**Classification:** AWS A5.14 ERNiCr-3

**Shielding gas:** Ar

**Polarity:** DCEP

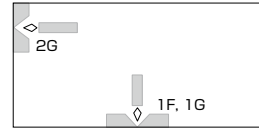
**Welding Positions:****Packaging data**

$\phi$ mm	Spool
1.2	10kg
<b>Volume mm</b>	240W, 110H, 240L

**Composition (wire mass%)**

	Typical	Guaranty <sup>a</sup>
<b>C</b>	0.03	0.10
<b>Si</b>	0.22	0.50
<b>Mn</b>	3.0	2.5~3.5
<b>P</b>	<0.01	0.03
<b>S</b>	0.002	0.015
<b>Ni</b>	72.0	67.0min.
<b>Cr</b>	20.0	18.0~22.0
<b>Ti</b>	0.28	0.75
<b>Fe</b>	1.7	3.0
<b>Nb+Ta</b>	2.6	2.0~3.0
<b>Cu</b>	0.01	0.50

Note: <sup>a</sup> Single values are maximum.

**Welding parameters (A)**

$\phi$ mm	1F, 1G, 2G
1.2	80~200

**All-weld mechanical properties**

	Typical
<b>0.2%YS (MPa)</b>	370
<b>TS (MPa)</b>	660
<b>EI on 4d (%)</b>	41
<b>IV -196°C (J)</b>	140

**Filler rod and wire**

<b>Features:</b>	▪ Suitable for Inconel and Incoloy, dissimilar-metal joints and overlaying
<b>Classification:</b>	AWS A5.14 ERNiCr-3
<b>Shielding gas:</b>	Ar
<b>Identification color:</b>	1st Purple
<b>Polarity:</b>	DCEN

**Packaging data**

ϕ mm	Spool	Tube		
	kg	kg	Length mm	g/piece
1.2	10	-	-	-
1.6	-	5	1,000	16
2.0	-	5	1,000	26
2.4	-	5	1,000	37
<b>Volume mm</b>	240W, 110H, 240L	40W, 35H, 1015L		

**Composition (rod and wire mass%)**

	Typical	Guaranty <sup>a</sup>
<b>C</b>	0.03	0.10
<b>Si</b>	0.20	0.50
<b>Mn</b>	2.9	2.5~3.5
<b>P</b>	0.001	0.03
<b>S</b>	0.002	0.015
<b>Ni</b>	72.9	67.0min.
<b>Cr</b>	20.1	18.0~22.0
<b>Ti</b>	0.30	0.75
<b>Fe</b>	1.4	3.0
<b>Nb+Ta</b>	2.6	2.0~3.0
<b>Cu</b>	<0.01	0.50

Note: <sup>a</sup> Single values are maximum.

**All-weld mechanical properties**

	Typical
<b>0.2%YS (MPa)</b>	370
<b>TS (MPa)</b>	680
<b>EI on 4d (%)</b>	40
<b>IV -196°C (J)</b>	150

## Filler rod and wire

<b>Features:</b>	▪ Suitable for Inconel 625, dissimilar-metal joints and overlaying
<b>Classification:</b>	AWS A5.14 ERNiCrMo-3
<b>Shielding gas:</b>	Ar
<b>Identification color:</b>	1st Brown
<b>Polarity:</b>	DCEN

## Packaging data

Ø mm	Spool	Tube		
	kg	kg	Length mm	g/piece
0.9	10	-	-	-
1.2	10	-	-	-
1.6	-	5	1,000	16
2.4	-	5	1,000	37
<b>Volume mm</b>	240W, 110H, 240L	40W, 35H, 1015L		

## Composition (rod and wire mass%)

	Typical	Guaranty <sup>a</sup>
<b>C</b>	0.01	0.10
<b>Si</b>	0.08	0.50
<b>Mn</b>	0.05	0.50
<b>P</b>	<0.01	0.02
<b>S</b>	0.001	0.015
<b>Ni</b>	63.6	58.0min.
<b>Cr</b>	21.9	20.0~23.0
<b>Mo</b>	9.0	8.0~10.0
<b>Nb+Ta</b>	3.55	3.15~4.15
<b>Al</b>	0.21	0.40
<b>Ti</b>	0.21	0.40
<b>Fe</b>	1.4	5.0
<b>Cu</b>	0.02	0.50

## All-weld mechanical properties

	Typical
<b>0.2%YS (MPa)</b>	480
<b>TS (MPa)</b>	770
<b>EI on 4d (%)</b>	41

Note: <sup>a</sup>Single values are maximum.

## Filler rod and wire

<b>Features:</b>	▪ Suitable for 9% Ni steel
<b>Classification:</b>	AWS A5.14 ERNiMo-8
<b>Shielding gas:</b>	Ar
<b>Identification color:</b>	1st Orange
<b>Polarity:</b>	DCEN

## Packaging data

ϕ mm	Spool			Tube		
	kg			kg	Length mm	g/piece
1.2	10	15	20	5	1,000	11
1.6	10	15	-	5	1,000	19
2.0	-	-	-	5	1,000	29
2.4	-	-	-	5	1,000	42
<b>Volume mm</b>	240W, 110H, 240L	285W, 110H, 285L		40W, 35H, 1015L		

## Composition (rod and wire mass%)

	Typical	Guaranty <sup>a</sup>
<b>C</b>	0.02	0.10
<b>Si</b>	0.02	0.50
<b>Mn</b>	<0.1	1.0
<b>P</b>	0.001	0.015
<b>S</b>	0.001	0.015
<b>Ni</b>	69.8	60.0min.
<b>Cr</b>	2.0	0.5~3.5
<b>Mo</b>	19.1	18.0~21.0
<b>W</b>	3.0	2.0~4.0
<b>Fe</b>	5.6	10.0
<b>Cu</b>	0.01	0.50

Note: <sup>a</sup> Single values are maximum.

## All-weld mechanical properties

	Typical	Guaranty
<b>0.2%YS (MPa)</b>	460	-
<b>TS (MPa)</b>	730	660min.
<b>EI on 4d (%)</b>	47	25min.
<b>IV -196°C (J)</b>	160	-

## Approvals

<b>ABS</b>	MG (AWS A5.14 ERNiMo-8)
<b>LR</b>	9Ni
<b>DNV</b>	MS (9Ni)
<b>BV</b>	Equivalent to AWS A5.14 ERNiMo-8
<b>NK</b>	KS WL92G ( I )

## Flux and wire combination

- Features:**
- Hastelloy type consumables
  - Suitable for horizontal and horizontal fillet welding of 9%Ni steel

**Classification:** AWS A5.14 ERNiMo-8 (Wire only)

**Type of flux:** Bonded

**Redrying of flux:** 200~300°Cx1h

**Polarity:** DCEP

## Packaging data

Flux	Mesh	Can		
PF-N4	12x65	20kg		
Volume mm		240W, 350H, 240L		
Wire	φ mm	Spool		Coil
US-709S	1.2	-	15kg	-
	1.6	10kg	15kg	-
	2.4	10kg	15kg	25kg
Volume mm		240W, 110H, 240L	285W, 110H, 285L	430W, 90H, 430L

## Composition (wire mass%)

	Typical	Guaranty <sup>a</sup>
<b>C</b>	0.02	0.10
<b>Si</b>	0.03	0.50
<b>Mn</b>	0.04	1.0
<b>P</b>	0.003	0.015
<b>S</b>	0.001	0.015
<b>Ni</b>	Bal.	60.0min.
<b>Cr</b>	2.0	0.5~3.5
<b>Mo</b>	18.9	18.0~21.0
<b>Cu</b>	0.01	0.50
<b>W</b>	3.0	2.0~4.0
<b>Fe</b>	5.6	10.0

Note: <sup>a</sup> Single values are maximum.

## Composition (all weld metal mass%)

	Typical
<b>C</b>	0.03
<b>Si</b>	0.82
<b>Mn</b>	0.4
<b>Ni</b>	66.1
<b>Cr</b>	1.7
<b>Mo</b>	18.1
<b>W</b>	2.7
<b>Fe</b>	9.5

## All-weld mechanical properties

	Typical	Guaranty
<b>0.2%YS (MPa)</b>	434	-
<b>TS (MPa)</b>	712	650min.
<b>EI on 4d (%)</b>	53	30min.
<b>IV -196°C (J)</b>	88	-

## Approvals

<b>ABS</b>	MG (AWS A5.14 ERNiMo-8)
<b>LR</b>	9NiM
<b>DNV</b>	MG
<b>BV</b>	UP
<b>NK</b>	KAWL92M
<b>CCS</b>	9Ni

# **Highly Efficient Welding Processes**

**FCB™ Process**

**FA-B**

**Electrogas Arc Welding**

# FCB™ Process

**Principles:**

FCB™ is an automatic one-side submerged arc welding process by which a uniform reverse side bead can be obtained. Welding is conducted from the surface side of the welding groove after supplying the backing flux, on the copper backing and pushing up the copper backing to the reverse side of the groove by the pressurized air hose.

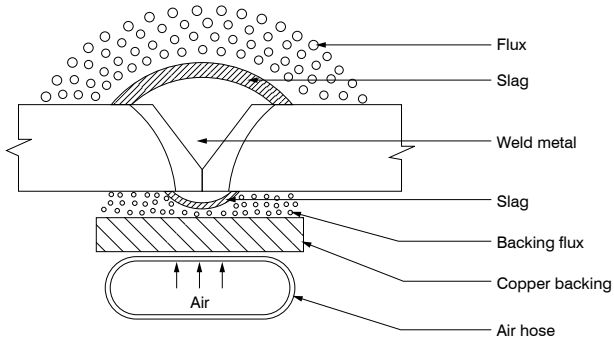

**Features:**

The combination of the backing flux and copper plate provides better contact onto the reverse side of the groove, which can accommodate a fluctuation of root gap and wide welding conditions to ensure consistent reverse bead without excessive melt through.

**Applications:**

Plate-to-plate butt welding for shipbuilding

**Typical welding consumables**

Type of steel	Flux	Wire	Backing flux
TMCP	PF-I55E	US-36	PF-I50R

Note: Redrying of flux: 200~300°Cx1h, Backing flux must not be dried by heating



## Packaging data

Flux: **PF-I55E**

Mesh size	Type	Weight (kg)
10x48	Aluminum-laminated kraft paper package, Can	20

Backing Flux: **PF-I50R**

Mesh size	Type	Weight (kg)
10x65	Can	20

Wire: **US-36**

$\phi$ mm	Coil (kg)	W x H x L
4.8	25	430, 90, 430
	75	740, 110, 740
	150	840, 110, 840
6.4	25	430, 90, 430
	78	740, 110, 740
	159	840, 110, 840

Approvals: **PF-I55E / US-36 / PF-I50R**

Number of electrodes	2	3	4
<b>ABS</b>	-	3Y, 3Y400	3Y, 3Y400
<b>LR</b>	3A, 3YA	3A, 3YA	3YA
<b>DNV</b>	III Y	III Y	III Y40
<b>BV</b>	-	A3YM	-
<b>NK</b>	KAW53SP	KAW53Y40SP	KAW53Y40SP
<b>CCS</b>	3Y	3Y	3Y

# FA-B

**Principles:**

FA-B1 is a flexible backing material suitable for the simplified one-side welding process shown below. It consists of glass fiber tapes, a refractory molded flux, a corrugated cardboard pad, a cover film and double-side adhesive tapes. It is attached the reverse side of the base metal by the adhesive tapes and fixed with an aluminum plate and magnet clamps.

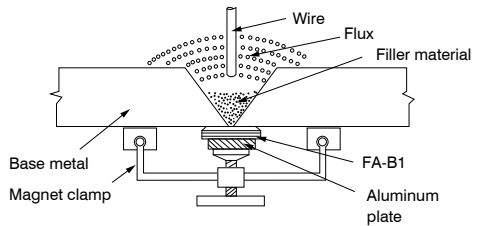
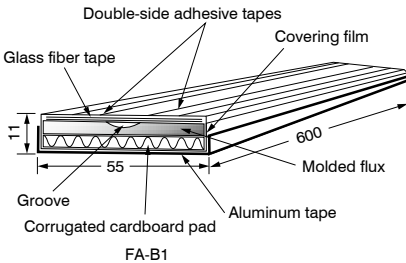

**Features:**

- (1) FA-B1 features good flexibility to assure close contact to the base metal. It can accommodate the weld joint misalignment, distortion and dissimilar-thickness transition of the weld joint.
- (2) The shape of reverse side bead are stable and can be obtained wider tolerance in welding conditions.

**Applications:**

Curved shell plates, deck plates, bottom plates, tank top plates of ships, steel deck plates of bridges, and other one-side welding

**Typical welding consumables**

Type of steel	Flux	Wire	Filler material	Backing material
Mild steel	MF-38	US-36	RR-2	FA-B1
	PF-I52E			
490MPa HT steel	MF-38	US-49	RR-2	FA-B1
	PF-I52E	US-36		

Note: Redrying conditions: **FA-B1** and **RR-2** must not be dried by heating  
**PF-I52E**: 200~300°Cx1h, **MF-38**: 150~350°Cx1h

## Packaging data

### Flux: PF-I52E

Mesh	Type	Weight (kg)	Package
10x48	Bonded	20	Al-laminated paper package, Can

### Flux: MF-38

Mesh	Type	Weight (kg)	Package
12x65	Fused	25	Can

### Wire: US-36 / US-49

φ mm	Coil (kg)	W x H x L
4.8	25	430, 90, 425
	75	735, 110, 735
	150	820, 110, 820
6.4	25	430, 90, 425
	78	745, 110, 745
	159	840, 110, 840

### Backing materials: FA-B1

Joint type	Length (mm)	Pieces / carton
Standard	600	40
Transition	600	30
Mismatch	600	30

### Approvals: PF-I52E / US-36 / RR-2 / FA-B1

Number of wires	Single	Tandem
ABS	3Y	3Y, 3Y400
LR	3A, 3YA	3A, 3YA
DNV	II Y	III Y
BV	A3YU	A3YM
NK	KAW53	KAW53Y40SMP
CR	3Y	3Y

# Electrogas Arc Welding

**Principles:**

Electrogas arc welding (EGW) is vertical-up butt welding. SEGARC™ is an automatic vertical welding process suitable for EGW. This process uses SEGARC™ 2Z equipment with the combination of a flux-cored wire, a sliding copper shoe, and a fixed backing.

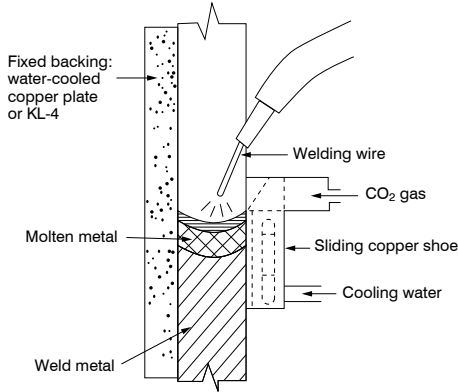

**Features:**

- (1) High deposition rates (e.g., 180g/min at 380A) provide high welding efficiency.
- (2) Lightweight, compact-size equipment makes it easy to set up.
- (3) Wire extension can be controlled constant against varied welding conditions.
- (4) Welding line can be located either on the left side (Standard) or, by re-assembling, the right side of the tracking rail.
- (5) With use of the oscillator (Option), it can be conducted maximum thickness 32 mm.
- (6) The carriage can be detached at any place from the tracking rail.

**Applications:**

- (1) Side shells, bulkheads, and hoppers in bulk carriers
- (2) Girder webs of box type and I-plate type in bridge
- (3) Press machine, storage tanks, large pipes, etc.

**Welding consumables**

Type of steel	Product names	Backing material
MS & 490MPa HT steel	DW-S43G	KL-4
MS & 490MPa HT steel for low temperature service	DW-S1LG	KL-4
550 to 610MPa HT steel	DW-S60G	KL-4

Note: Polarity: DCEP, SG: CO<sub>2</sub>

### Packaging data

$\phi$ mm	Spool
1.6	20kg

### Typical composition of weld metal (%)

Product names	DW-S43G	DW-S1LG	DW-S60G
<b>C</b>	0.08	0.05	0.08
<b>Si</b>	0.35	0.25	0.32
<b>Mn</b>	1.63	1.6	1.67
<b>P</b>	0.014	0.009	0.01
<b>S</b>	0.01	0.007	0.008
<b>Ni</b>	0.02	1.4	0.71
<b>Mo</b>	0.17	0.13	0.25
<b>Ti</b>	0.02	0.05	0.03

### Typical properties of weld metal

Product names	DW-S43G	DW-S1LG	DW-S60G
<b>0.2%YS (MPa)</b>	470	500	520
<b>TS (MPa)</b>	600	615	650
<b>El on 4d (%)</b>	27	25	26
<b>IV (J)</b>	-20°C: 62	-60°C: 100	-20°C: 65

### Approvals: DW-S43G/KL-4/CO<sub>2</sub>

<b>ABS</b>	○
<b>LR</b>	3, 3Y
<b>DNV</b>	IIIY
<b>BV</b>	AV3Y
<b>NK</b>	KEW53, KEW52Y40
<b>CR</b>	3Y
<b>KR</b>	3YV
<b>CCS</b>	3Y

### Approvals: DW-S1LG/KL-4/CO<sub>2</sub>

<b>ABS</b>	○
<b>LR</b>	4Y, 5Y40
<b>DNV</b>	VY, VY40
<b>NK</b>	KEW54Y40, MG

○: Subject to satisfactory procedure test by user



# **Appendix**

**Redrying Conditions**  
**Package Specifications**  
**Unit conversion Tables**  
**F-No. and A-No.**  
**AWS**  
**EN**

## Redrying Conditions

### Stick electrodes

Applicable steel	AWS Class.	Typical	Redrying temperature (°C)	Redrying time (hour.)	Holding temperature (°C)
Mild	E6019 E6013 E7024	B-10, B-14, B-17, Z-44, RB-26, B-33	70-100	0.5-1	-
	E7016	LB-26, LB-52U	300-350	0.5-1	100-150
Weather proof	E7016-G	LB-W52	300-350	1	100-150
		LB-W52B	350-400		
High tensile or low temperature	-	LT-B50	70-100	0.5-1	-
	E7016 E7018 E7048 E7016-G E7018-1 E9016-G E8016-G E8016-C1 E8018-G E9018-G E10016-G E11018-G E11016-G E7016-C2L	LB-52, LB-52-18, LB-52T, LT-B52A	300-350	0.5-1	100-150
		LB-52A, LB-7018-1, LB-55NS, LB-55U, LB-8018 LB-57, LB-62, LB-62D, LB-62L, LB-62U, LB-65L, LB-67L, LB-106, LB-70L, LB-116, LB-80L, LB-78VS, LB-88VS, LB-98VS, LB-52NS, NB-1SJ, NB-3J	350-400	1	100-150
		LB-62UL, LB-80UL, LB-88LT	350-430	1	100-150
Heat-resistant	E7016-A1 E9016-G E8016-B2 E9016-B3 E9016-G E8016-B8 E9015-B9 E9016-B91 E7015-B2L E8018-B2 E8015-B3L E9018-B3 E8016-B6	BL-96, CM-2CW, CM-5, CM-9, CM-95B91, CM-96B91, CM-9Cb, CM-A76, CM-A96, CM-A96MB, CM-A96MBD, CM-A106, CM-A106N, CM-A106ND, CM-A106H, CM-A106HD, CM-B95, CM-B98, CM-B105, CM-B108, CR-12S	325-375	1	100-150



## Stick electrodes

Applicable steel or metal	Product names	Redrying temperature (°C)	Redrying time (hour)	Holding temperature (°C)
stainless steel	NC-xxx	150-200	0.5-1	100-150
	CR-40, CR-40Cb	300-350	0.5-1	100-150
Hardfacing	HF-240, HF-330	70-100	0.5-1	-
	HF-12, HF-13, HF-30, HF-260, HF-350, HF-450, HF-500, HF-600, HF-650, HF-700, HF-800K	300-350	0.5-1	100-150
	HF-11, HF-16, HF-950	150-200	0.5-1	100-150
Cast iron	CI-A3	300-350	0.5-1	100-150
	CI-A1, CI-A2	70-100	0.5-1	-
Ni alloy	NI-C1S, NI-C70A, NI-C70S, NI-C625, NI-C703D	200-250	0.5-1	100-150

## Fluxes

Type	Product names	Redrying temperature (°C)	Redrying time (hour)	Holding temperature (°C)
Fused	G-50, G-60, G-80, MF-38 MF-53, MF-300 MF-38 G-80, MF-27, MF-38 G-50	150-350	1	100-150
Bonded	PF-H55E, PF-I52E, PF-I55E, PF-H55AS PF-H203 PF-S1D PF-H55LT, PF-200 PF-200S, PF-500 PF-200D, PF-500D, PF-90B91 PF-N3, PF-N4 PF-H62AS/AK	200-300	1	100-150
	PF-H80AK, PF-H80AS	250-350	1	100-150
Sintered	AF-490E, AF-490SP, AF-490AS	200-300	1	100-150

# Package Specifications

## Spoiled wires

kg	Diameter A (mm)	Width B (mm)	Diameter C (mm)
10	225	103	53
12.5 & 12.7	280	103	53
15	280	103	53
Solid 20	270	103	53
20	280	103	53

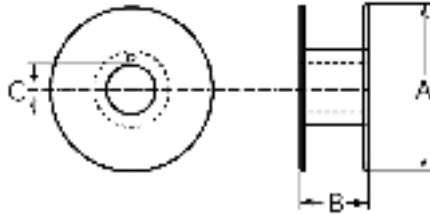

## Coiled wires

kg	Diameter A (mm)	Width B (mm)	Diameter C (mm)
12.5	375	64	305
25 (Except 4.8 $\phi$ )	410	80	310
25 (4.8 $\phi$ )	405	77	310
75	750	115	640
150	825	115	640
159	835	115	640

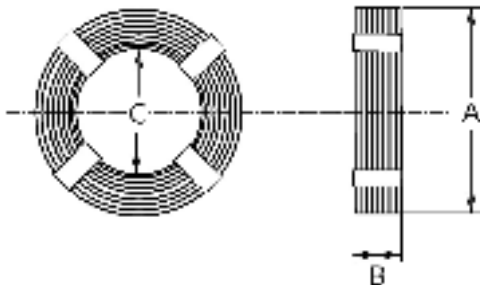

# Package Specifications

## Pail pack (Drum)

### 1. Principles:

Pail pack is a drum of large amounts of wires. The wire is spooled to be elastically twisted in the drum so that the wire can be pulled out straight without rotation of the drum. The wire makes good tracking on a welding seam. The use of Pail pack wires can reduce the downtime for changing wires when compared with spooled wires, which is effective particularly for robotic welding and other automatic welding.

### 2. Package specifications:

Solid wire			
$\phi$ mm	Weight (kg)	Volume <sup>*a</sup> (mm)	Suitable Hat
0.8	100	530 $\phi$ $\times$ 500H	AH-500
0.9	250	530 $\phi$ $\times$ 820H	
1.0			
1.4			
1.2	300		
1.4	400	680 $\phi$ $\times$ 770H	AH-660
1.6			

Flux-cored wire			
Wire size (mm)	Weight (kg)	Volume <sup>*a</sup> (mm)	Suitable Hat
1.2 1.4	250	530 $\phi$ $\times$ 820H	AH-500
1.6	350	680 $\phi$ $\times$ 770H	AH-660

\*a: Volume, including the hanging bracket

### 3. Arrangement

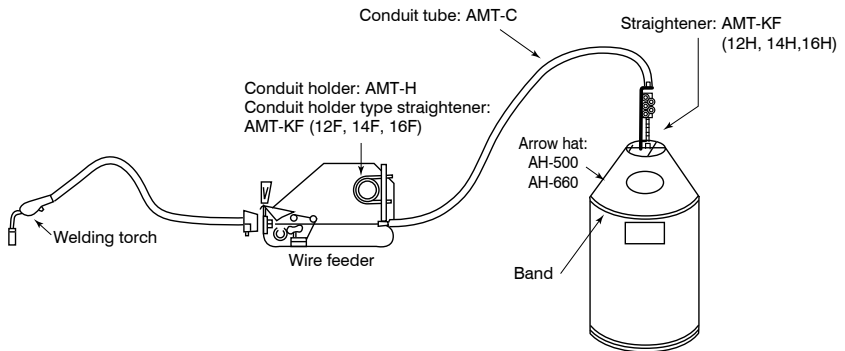

# Conversions for Temperature

°F	°C	°F	°C	°F	°C	°F	°C	°F	°C	°F	°C
-459.4	-273	-10	-23.3	86	30.0	174	78.9	430	221.1	1240	671
-440	-262	0	-17.8	88	31.1	176	80.0	440	226.7	1260	682
-430	-257	2	-16.7	90	32.2	178	81.1	450	232.2	1280	693
-420	-251	4	-15.6	92	33.3	180	82.2	460	237.8	1300	704
-410	-246	6	-14.4	94	34.4	182	83.3	470	243.3	1320	716
-400	-240	8	-13.3	96	35.6	184	84.4	480	248.9	1340	727
-390	-234	10	-12.2	98	36.7	186	85.6	490	254.4	1360	738
-380	-229	12	-11.1	100	37.8	188	86.7	500	260.0	1380	749
-370	-223	14	-10.0	102	38.9	190	87.8	520	271.1	1400	760
-360	-218	16	-8.9	104	40.0	192	88.9	540	282.2	1420	771
-350	-212	18	-7.8	106	41.1	194	90.0	560	293.3	1440	782
-340	-207	20	-6.7	108	42.2	196	91.1	580	304.4	1460	793
-330	-201	22	-5.6	110	43.3	198	92.2	600	315.6	1480	804
-320	-196	24	-4.4	112	44.4	200	93.3	620	326.7	1500	816
-310	-190	26	-3.3	114	45.6	202	94.4	640	337.8	1520	827
-300	-184	28	-2.2	116	46.7	204	95.6	660	348.9	1540	838
-290	-179	30	-1.1	118	47.8	206	96.7	680	360.0	1560	849
-280	-173	32	0.0	120	48.9	208	97.8	700	371.1	1580	860
-270	-168	34	1.1	122	50.0	210	98.9	720	382.2	1600	871
-260	-162	36	2.2	124	51.1	212	100.0	740	393.3	1620	882
-250	-157	38	3.3	126	52.2	214	101.1	760	404.4	1640	893
-240	-151	40	4.4	128	53.3	216	102.2	780	415.6	1660	904
-230	-146	42	5.6	130	54.4	218	103.3	800	426.7	1680	916
-220	-140	44	6.7	132	55.6	220	104.4	820	437.8	1700	927
-210	-134	46	7.8	134	56.7	230	110.0	840	448.9	1720	938
-200	-129	48	8.9	136	57.8	240	115.6	860	460.0	1740	949
-190	-123	50	10.0	138	58.9	250	121.1	880	471.1	1760	960
-180	-118	52	11.1	140	60.0	260	126.7	900	482.2	1780	971
-170	-112	54	12.2	142	61.1	270	132.2	920	493.3	1800	982
-160	-107	56	13.3	144	62.2	280	137.8	940	504.4	1820	993
-150	-101	58	14.4	146	63.3	290	143.3	960	515.6	1840	1004
-140	-96	60	15.6	148	64.4	300	148.9	980	527	1860	1016
-130	-90	62	16.7	150	65.6	310	154.4	1000	538	1880	1027
-120	-84	64	17.8	152	66.7	320	160.0	1020	549	1900	1038
-110	-79	66	18.9	154	67.8	330	165.6	1040	560	1920	1049
-100	-73	68	20.0	156	68.9	340	171.1	1060	571	1940	1060
-90	-68	70	21.1	158	70.0	350	176.7	1080	582	1960	1071
-80	-62	72	22.2	160	71.1	360	182.2	1100	593	1980	1082
-70	-57	74	23.3	162	72.2	370	187.8	1120	604	2000	1093
-60	-51	76	24.4	164	73.3	380	193.3	1140	616		
-50	-45.6	78	25.6	166	74.4	390	198.9	1160	627		
-40	-40.0	80	26.7	168	75.6	400	204.4	1180	638		
-30	-34.4	82	27.8	170	76.7	410	210.0	1200	649		
-20	-28.9	84	28.9	172	77.8	420	215.6	1220	660		

$$^{\circ}\text{F} = \left(\frac{9}{5} \times ^{\circ}\text{C}\right) + 32 \quad ^{\circ}\text{C} = \frac{5}{9} \times (^{\circ}\text{F} - 32)$$

# Conversions for Tensile Stress

**ksi → MPa** (Extracted from ASTM E380)

**1 ksi = 6.89476 MPa**

ksi	0	1	2	3	4	5	6	7	8	9
	<b>MPa</b>									
<b>0</b>	-	6.89	13.79	20.68	27.58	34.47	41.37	48.26	55.16	62.05
<b>10</b>	68.95	75.84	82.74	89.63	96.53	103.42	110.32	117.21	124.11	131.00
<b>20</b>	137.90	144.80	151.68	158.58	165.47	172.37	179.26	186.16	193.05	199.95
<b>30</b>	206.84	213.74	220.63	227.53	234.42	241.32	248.21	255.11	262.00	268.90
<b>40</b>	275.79	282.69	289.58	296.47	303.37	310.26	317.16	324.05	330.95	337.84
<b>50</b>	344.74	351.63	358.53	365.42	372.32	379.21	386.11	393.00	399.90	406.79
<b>60</b>	413.69	420.58	427.47	434.37	441.26	448.16	455.05	461.95	468.84	475.74
<b>70</b>	482.63	489.53	496.42	503.32	510.21	517.11	524.00	530.90	537.79	544.69
<b>80</b>	551.58	558.48	565.37	572.26	579.16	586.05	592.95	599.84	606.74	613.63
<b>90</b>	620.53	627.42	634.32	641.21	648.11	655.00	661.90	668.79	675.69	682.58
<b>100</b>	689.48									

**MPa → ksi** (Extracted from BS350 Part 2)

**1 MPa = 0.145038 ksi**

MPa	0	1	2	3	4	5	6	7	8	9
	<b>ksi</b>									
<b>0</b>	-	0.145	0.290	0.435	0.580	0.725	0.870	1.015	1.160	1.305
<b>10</b>	1.450	1.595	1.740	1.886	2.031	2.176	2.321	2.466	2.611	2.756
<b>20</b>	2.901	3.046	3.191	3.336	3.481	3.626	3.771	3.916	4.061	4.206
<b>30</b>	4.351	4.496	4.641	4.786	4.931	5.076	5.221	5.366	5.511	5.656
<b>40</b>	5.802	5.947	6.092	6.237	6.382	6.527	6.672	6.817	6.962	7.107
<b>50</b>	7.252	7.397	7.542	7.687	7.832	7.977	8.122	8.267	8.412	8.557
<b>60</b>	8.702	8.847	8.992	9.137	9.282	9.427	9.572	9.718	9.863	10.008
<b>70</b>	10.153	10.298	10.443	10.588	10.733	10.878	11.023	11.168	11.313	11.458
<b>80</b>	11.603	11.748	11.893	12.038	12.183	12.328	12.473	12.618	12.763	12.908
<b>90</b>	13.053	13.198	13.344	13.489	13.634	13.779	13.924	14.069	14.214	14.359
<b>100</b>	14.504									

# Conversions for Impact Energy

ft -lbf → J (Extracted from BS350 Part 2)

1 ft -lbf = 1.35582 J

ft -lbf	0	1	2	3	4	5	6	7	8	9
	<b>J</b>									
<b>0</b>	-	1.36	2.71	4.07	5.42	6.78	8.13	9.49	10.85	12.20
<b>10</b>	13.56	14.91	16.27	17.63	18.98	20.34	21.69	23.05	24.40	25.76
<b>20</b>	27.12	28.47	29.83	31.18	32.54	33.90	35.25	36.61	37.96	39.32
<b>30</b>	40.67	42.03	43.39	44.74	46.10	47.45	48.81	50.17	51.52	52.88
<b>40</b>	54.23	55.59	56.94	58.30	59.66	61.01	62.37	63.72	65.08	66.44
<b>50</b>	67.79	69.15	70.50	71.86	73.21	74.57	75.93	77.28	78.64	79.99
<b>60</b>	81.35	82.70	84.06	85.42	86.77	88.13	89.48	90.84	92.20	93.55
<b>70</b>	94.91	96.26	97.62	98.97	100.33	101.69	103.04	104.40	105.75	107.11
<b>80</b>	108.47	109.82	111.18	112.53	113.89	115.25	116.60	117.96	119.31	120.67
<b>90</b>	122.02	123.38	124.74	126.09	127.45	128.80	130.16	131.51	132.87	134.23
<b>100</b>	135.58									

J → ft -lbf (Extracted from BS350 Part 2)

1 J = 0.737563 ft -lbf

J	0	1	2	3	4	5	6	7	8	9
	<b>ft - lbf</b>									
<b>0</b>	-	0.738	1.475	2.213	2.950	3.688	4.425	5.163	5.901	6.638
<b>10</b>	7.376	8.113	8.851	9.588	10.326	11.063	11.801	12.539	13.276	14.014
<b>20</b>	14.751	15.489	16.226	16.964	17.702	18.439	19.177	19.914	20.652	21.389
<b>30</b>	22.127	22.864	23.602	24.340	25.077	25.815	26.552	27.290	28.027	28.765
<b>40</b>	29.503	30.240	30.978	31.715	32.453	33.190	33.928	34.665	35.403	36.141
<b>50</b>	36.878	37.616	38.353	39.091	39.828	40.566	41.304	42.041	42.779	43.516
<b>60</b>	44.254	44.991	45.729	46.466	47.204	47.942	48.679	49.417	50.154	50.892
<b>70</b>	51.629	52.367	53.105	53.842	54.580	55.317	56.055	56.792	57.530	58.267
<b>80</b>	59.005	59.743	60.480	61.218	61.955	62.693	63.430	64.168	64.906	65.643
<b>90</b>	66.381	67.118	67.856	68.593	69.331	70.068	70.806	71.544	72.281	73.019
<b>100</b>	73.756									

# Conversions for Hardness

Vickers Hardness (DPH)	Brinell hardness 10mm ball 3000kg load		Tensile Strength MPa (approx.)
	Standard ball	Tungsten carbide ball	
940	-	-	-
920	-	-	-
900	-	-	-
880	-	767	-
860	-	757	-
840	-	745	-
820	-	733	-
800	-	722	-
780	-	710	-
760	-	698	-
740	-	684	-
720	-	670	-
700	-	656	-
690	-	647	-
680	-	638	-
670	-	630	-
660	-	620	-
650	-	611	-
640	-	601	-
630	-	591	-
620	-	582	-
610	-	573	-
600	-	564	-
590	-	554	2095
580	-	545	2020
570	-	535	1981
560	-	525	1952
550	505	517	1912
540	496	507	1863
530	488	497	1824
520	480	488	1795
510	473	479	1755
500	465	471	1706
490	456	460	1657
480	448	452	1618
470	441	442	1569
460	433	433	1530
450	425	425	1500
440	415	415	1461
430	405	405	1412
420	397	397	1373

Vickers Hardness (DPH)	Brinell hardness 10mm ball 3000kg load		Tensile Strength MPa (approx.)
	Standard ball	Tungsten carbide ball	
410	388	388	1334
400	379	379	1285
390	369	369	1245
380	360	360	1206
370	350	350	1177
360	341	341	1128
350	331	331	1098
340	322	322	1069
330	313	313	1030
320	303	303	1010
310	294	294	981
300	284	284	951
295	280	280	941
290	275	275	922
285	270	270	902
280	265	265	892
275	261	261	873
270	256	256	853
265	252	252	843
260	247	247	824
255	243	243	804
250	238	238	794
245	233	233	775
240	228	228	765
230	219	219	736
220	209	209	696
210	200	200	667
200	190	190	637
190	181	181	608
180	171	171	579
170	162	162	549
160	152	152	520
150	143	143	490
140	133	133	451
130	124	124	431
120	114	114	392
110	105	105	-
100	95	95	-
95	90	90	-
90	86	86	-
85	81	81	-

Note: These conversions are excerpted from the relevant JIS and ASTM standards, which are based on the data of carbon steels. Therefore, weld metals may exhibit different conversions more or less particularly in the case of alloyed weld metals with higher hardness.

## F-No. Grouping and A-No. Classification (A part is extracted)

Note: The F-No. grouping and A-No. classification of welding consumables shown below are excerpted from ASME Sec. IX 2015 Edition. The F No. and A No. of KOBELCO products are shown in the "List of Welding Consumables" listed at pages from 10 to 21.

### F-No. grouping of welding consumables

F No.	ASME Specification	AWS Classification
1	SFA-5.1	EXX20, EXX22, EXX24, EXX27, EXX28
1	SFA-5.4	EXXX(X)-26
1	SFA-5.5	EXX20-X, EXX27-X
2	SFA-5.1	EXX12, EXX13, EXX14, EXX19
2	SFA-5.5	E(X)XX13-X
3	SFA-5.1	EXX10, EXX11
3	SFA-5.5	E(X)XX10-X, E(X)XX11-X
4	SFA-5.1	EXX15, EXX16, EXX18, EXX18M, EXX48
4	SFA-5.4 Other than austenitic and duplex	EXXX(X)-15, EXXX(X)-16, EXXX(X)-17
4	SFA-5.5	E(X)XX15-X, E(X)XX16-X, E(X)XX18-X, E(X)XX18M, E(X)XX18M1, E(X)XX45
5	SFA-5.4 Austenitic and duplex	EXXX(X)-15, EXXX(X)-16, EXXX(X)-17
6	SFA-5.2, SFA-5.9, SFA-5.17, SFA-5.18, SFA-5.20, SFA-5.22, SFA-5.23, SFA-5.25, SFA-5.26, SFA-5.28, SFA-5.29	All classifications
6	SFA-5.30	INMs-X, IN5XX, IN3XX(X)
41	SFA-5.11	ENi-1
41	SFA-5.14	ERNi-1
41	SFA-5.30	IN61
42	SFA-5.11	ENiCu-7
42	SFA-5.14	ERNiCu-7, ERNiCu-8
42	SFA-5.30	IN60
43	SFA-5.11	ENiCr-4, ENiCrFe-1, ENiCrFe-2, ENiCrFe-3, ENiCrFe-4, ENiCrFe-7, ENiCrFe-9, ENiCrFe-10, ENiCrFe-12, ENiCrCoMo-1, ENiCrMo-2, ENiCrMo-3, ENiCrMo-4, ENiCrMo-5, ENiCrMo-6, ENiCrMo-7, ENiCrMo-10, ENiCrMo-12, ENiCrMo-13, ENiCrMo-14, ENiCrMo-17, ENiCrMo-18, ENiCrMo-19, ENiCrWMo-1

(Continued)



F No.	ASME Specification	AWS Classification
43	SFA-5.14	ERNiCr-3, ERNiCr-4, ERNiCr-6, ERNiCrFe-5, ERNiCrFe-6, ERNiCrFe-7, ERNiCrFe-7A, ERNiCrFe-8, ERNiCrFe-11, ERNiCrFe-12, ERNiCrFeAl-1, ERNiCrCoMo-1, ERNiCrMo-2, ERNiCrMo-3, ERNiCrMo-4, ERNiCrMo-7, ERNiCrMo-10, ERNiCrMo-13, ERNiCrMo-14, ERNiCrMo-16, ERNiCrMo-17, ERNiCrMo-18, ERNiCrMo-19, ERNiCrMo-20, ERNiCrMo-21, ERNiCrWMo-1
43	SFA-5.30	IN82, IN62, IN6A, IN52
43	SFA-5.34	All classifications
44	SFA-5.11	ENiMo-1, ENiMo-3, ENiMo-7, ENiMo-8, ENiMo-9, ENiMo-10, ENiMo-11
44	SFA-5.14	ERNiMo-1, ERNiMo-2, ERNiMo-3, ERNiMo-7, ERNiMo-8, ERNiMo-9, ERNiMo-10, ERNiMo-11, ERNiMo-12
45	SFA-5.11	ENiCrMo-1, ENiCrMo-9, ENiCrMo-11
45	SFA-5.14	ERNiCrMo-1, ERNiFeCr-1, ERNiCrMo-8, ERNiCrMo-9, ERNiCrMo-11
46	SFA-5.11	ENiCrFeSi-1
46	SFA-5.14	ERNiCrFeSi-1, ERNiCoCrSi-1

#### A-No. classification of ferrous weld metal

A No.	Types of weld deposit	Chemical composition (mass %)					
		C	Cr	Mo	Ni	Mn	Si
1	Mild steel	0.20	0.20	0.30	0.50	1.60	1.0
2	C-Mo	0.15	0.50	0.40-0.65	0.50	1.60	1.0
3	Cr (0.4-2%)-Mo	0.15	0.40-2.00	0.40-0.65	0.50	1.60	1.0
4	Cr (2-4%)-Mo	0.15	2.00-4.00	0.40-1.50	0.50	1.60	2.0
5	Cr (4-10.5%)-Mo	0.15	4.00-10.5	0.40-1.50	0.80	1.20	2.0
6	Cr-Martensitic	0.15	11.0-15.0	0.70	0.80	2.00	1.0
7	Cr-Ferritic	0.15	11.0-30.0	1.00	0.80	1.00	3.0
8	Cr-Ni	0.15	14.5-30.0	4.00	7.50-15.0	2.50	1.0
9	Cr-Ni	0.30	19.0-30.0	6.00	15.0-37.0	2.50	1.0
10	Ni to 4%	0.15	0.50	0.55	0.80-4.00	1.70	1.0
11	Mn-Mo	0.17	0.50	0.25-0.75	0.85	1.25-2.25	1.0
12	Ni-Cr-Mo	0.15	1.50	0.25-0.80	1.25-2.80	0.75-2.25	1.0

Note: Single values are maximum.

# AWS A5.1-2012

## Carbon Steel Electrodes for Shielded Metal Arc Welding

### Classification system

E ① ② – ③ ④ ⑤ [Ex.] E60 10 E70 16-1 H8 R

E: Stick electrodes

①: All-weld metal tension test requirements & chemical composition requirements

Classification		Tensile strength (ksi)	Yield strength at 0.2% offset (ksi)	Elongation on 4d (%)
E 60	10	60min.	48min.	22min.
	11	60min.	48min.	22min.
	12	60min.	48min.	17min.
	13	60min.	48min.	17min.
	18	60min.	48min.	22min.
	19	60min.	48min.	22min.
	20	60min.	48min.	22min.
E 70	27	60min.	48min.	22min.
	14	70min.	58min.	17min.
	15	70min.	58min.	22min.
	16	70min.	58min.	22min.
	18	70min.	58min.	22min.
	24	70min.	58min.	17min.
	27	70min.	58min.	22min.
	28	70min.	58min.	22min.
	48	70min.	58min.	22min.
	18M <sup>(4)</sup>	Note <sup>(2)</sup>	53~72 <sup>(3)</sup>	24min.

Note: (1) Single values are maximum. N.S. means Not Specified.

(2) Nominal 70ksi

(3) For 3/32in.(2.4mm) electrodes, the maximum yield strength shall be 77ksi

(4) For mostly military applications

	<b>C</b>	<b>Si</b>	<b>Mn</b>	<b>P</b>	<b>S</b>	<b>Ni</b>	<b>Cr</b>	<b>Mo</b>	<b>V</b>	<b>Combined Limit for Mn+Ni+Cr+Mo+V</b>
	0.20	1.00	1.20	N.S.	N.S.	0.30	0.20	0.30	0.08	N.S.
	0.20	1.00	1.20	N.S.	N.S.	0.30	0.20	0.30	0.08	N.S.
	0.20	1.00	1.20	N.S.	N.S.	0.30	0.20	0.30	0.08	N.S.
	0.20	1.00	1.20	N.S.	N.S.	0.30	0.20	0.30	0.08	N.S.
	0.03	0.40	0.60	0.025	0.015	0.30	0.20	0.30	0.08	N.S.
	0.20	1.00	1.20	N.S.	N.S.	0.30	0.20	0.30	0.08	N.S.
	0.20	1.00	1.20	N.S.	N.S.	0.30	0.20	0.30	0.08	N.S.
	0.20	1.00	1.20	N.S.	N.S.	0.30	0.20	0.30	0.08	N.S.
	0.15	0.90	1.25	0.035	0.035	0.30	0.20	0.30	0.08	1.50
	0.15	0.90	1.25	0.035	0.035	0.30	0.20	0.30	0.08	1.50
	0.15	0.75	1.60	0.035	0.035	0.30	0.20	0.30	0.08	1.75
	0.15	0.75	1.60	0.035	0.035	0.30	0.20	0.30	0.08	1.75
	0.15	0.90	1.25	0.035	0.035	0.30	0.20	0.30	0.08	1.50
	0.15	0.75	1.60	0.035	0.035	0.30	0.20	0.30	0.08	1.75
	0.15	0.90	1.60	0.035	0.035	0.30	0.20	0.30	0.08	1.75
	0.15	0.90	1.60	0.035	0.035	0.30	0.20	0.30	0.08	1.75
	0.12	0.80	0.40~1.60	0.030	0.020	0.25	0.15	0.35	0.05	N.S.

②: All-weld metal Charpy V-notch impact requirements

Classification		Impact value			Welding position <sup>(1)</sup>	Type of current
		Limits for 3 out of 5 specimens <sup>(2)</sup>				
		Temp. (°F)	average (ft-lbf)	single (ft-lbf)		
E 60	10	-20	20min.	15min.	F, V, OH, H	DCEP
	11					AC or DCEP
	12	Not specified			F, V, OH, H	AC or DCEN
	13	Not specified				AC, DCEP or DCEN
	18	-20	20min.	15min.	F, V, OH, H	AC or DCEP
	19	0	20min.	15min.	F, V, OH, H	AC, DCEP or DCEN
	20	Not specified			H-Fil, F	AC or DCEN AC, DCEP or DCEN
	22	Not specified			F, H-Fil	AC or DCEN
27	-20	20min.	15min.	H-Fil, F	AC or DCEN AC, DCEP or DCEN	
E 70	14	Not specified			F, V, OH, H	AC, DCEP or DCEN
	15	-20	20min.	15min.	F, V, OH, H	DCEP
	16					AC or DCEP
	18				F, V, OH, H	AC or DCEP
	24	Not specified			H-Fil, F	AC, DCEP or DCEN
	27	-20	20min.	15min.	H-Fil, F	AC or DCEN AC, DCEP or DCEN
	28	0	20min.	15min.	H-Fil, F	AC or DCEP
	48	-20	20min.	15min.	F, OH, H, V-down	AC or DCEP
	18M	All five specimens <sup>(3)</sup>			F, V, OH, H	DCEP
-20		50min.	40min.			

Note: (1) Welding position: F: Flat, H: Horizontal, H-Fil: Horizontal fillet, V-down: Vertical down  
V: Vertical, OH: Overhead

(2) Both the highest and lowest values obtained shall be disregarded in computing the average. Two of these remaining three values shall equal or exceed 20ft-lbf.

(3) All five values obtained shall be used in computing the average. Four of the five values shall equal, or exceed, 50 ft-lbf.

③: Requirements for low temperature impact value (Option)

Classification	Additional Designator	Impact Requirements		
		3 out of 5 specimens		
		Temp. (°F)	Average, Min. (ft-lbf)	Single value, Min. (ft-lbf)
E 7016 E 7018	1	-50	20	15
E 7024		0	20	15

④: Diffusible hydrogen limits for weld metal (Option)

Classification	Diffusible Hydrogen Designator	Diffusible hydrogen content, Average mL/100g deposited metal, Max
E 7018M	None	4
E 7015 E 7016 E 7018 E 7028 E 7048	H16 H8 H4	16 8 4

⑤: Absorbed moisture content limits in electrode coverings (Option)

Electrode Designation	Limit of moisture content (wt.%), Max	
	As-received or Conditioned	As-exposed
E 7015 E 7016 E 7016-1 E 7018 E 7018-1 E 7028 E 7048	0.6	Not specified
E 7015R E 7016R E 7016-1R E 7018R E 7018-1R E 7028R E 7048R	0.3	0.4
E 7018M	0.1	0.4

# AWS A5.5-2014

## Low-Alloy Steel Electrodes for Shielded Metal Arc Welding

### Classification system

E ① ② – ③ [Ex.] E 70 16 – A1  
E 100 18 – D2

E : Stick electrodes

①: All-weld-metal tensile strength and related requirements<sup>(1)</sup>

Classification	TS, Min. (ksi)	EI, Min. (%)	IV, Min. <sup>(2)</sup> (ft-lb)
70	70 75	11-24 according to class.	Av. 20 Each 15 at specific temperature depending on classification
80	80		
90	90		
100	100		
110	110		
120	120		

Note (1) PWHT is specified depending on classification.

(2) Not specified for EXXX-A1, -BX, -BXL, and -G

②: Type of covering, welding position, and related requirements

Classification	Type of covering	Welding position	Type of current
10	High cellulose sodium	F, V, OH, H	DCEP
11	High cellulose potassium		AC or DCEP
13	High titania potassium	F, V, OH, H	AC, DCEP or DCEN
15	Low hydrogen sodium	F, V, OH, H	DCEP
16	Low hydrogen potassium		AC or DCEP
18	Low hydrogen potassium, iron powder	F, V, OH, H	AC or DCEP
20	High iron oxide	H-Fil	AC or DCEN
		F	AC, DCEP or DCEN
27	High iron oxide, iron powder	H-Fil	AC or DCEN
		F	AC, DCEP or DCEN

Note: 1. F: Flat, V: Vertical,

OH: Overhead, H-Fil: Horizontal fillet

H: Horizontal

③: Chemical composition of all-weld metal

Classification	Chemical composition (%)								
	C	Mn	Si	P	S	Ni	Cr	Mo	Others
Cr-Mo steel electrodes									
E7010-A1	0.12	0.60	0.40	0.03	0.03	-	-	0.40-0.65	-
E7011-A1			0.60						
E7020-A1			0.60						
E7015-A1			0.90						
E7016-A1			0.80						
E7018-A1			1.00						
E7027-A1									
E8016-B1	0.05-0.12	0.90	0.60	0.03	0.03	-	0.40-0.65	0.40-0.65	-
E8018-B1			0.80						
E8015-B2	0.05-0.12	0.90	1.00	0.03	0.03	-	1.00-1.50	0.40-0.65	-
E8016-B2			0.60						
E8018-B2			0.80						
E7015-B2L	0.05	0.90	1.00	0.03	0.03	-	1.00-1.50	0.40-0.65	-
E7016-B2L			0.60						
E7018-B2L			0.80						
E9015-B3	0.05-0.12	0.90	1.00	0.03	0.03	-	2.00-2.50	0.90-1.20	-
E9016-B3			0.60						
E9018-B3			0.80						
E8015-B3L	0.05	0.90	1.00	0.03	0.03	-	2.00-2.50	0.90-1.20	-
E8018-B3L			0.80						
E8015-B4L	0.05	0.90	1.00	0.03	0.03	-	1.75-2.25	0.40-0.65	-
E8016-B5	0.07-0.15	0.40-0.70	0.30-0.60	0.03	0.03	-	0.40-0.60	1.00-1.25	V: 0.05
E8015-B6	0.05-0.10	1.0	0.90	0.03	0.03	0.40	4.0-6.0	0.45-0.65	-
E8016-B6									
E8018-B6									
E9018-B6									
E8015-B6L	0.05	1.0	0.90	0.03	0.03	0.40	4.0-6.0	0.45-0.65	-
E8016-B6L									
E8018-B6L									
E8015-B7	0.05-0.10	1.0	0.90	0.03	0.03	0.40	6.0-8.0	0.45-0.65	-
E8016-B7									
E8018-B7									
E8015-B7L	0.05	1.0	0.90	0.03	0.03	0.40	6.0-8.0	0.45-0.65	-
E8016-B7L									
E8018-B7L									
E8015-B8	0.05-0.10	1.0	0.90	0.03	0.03	0.40	8.0-10.5	0.85-1.20	-
E8016-B8									
E8018-B8									

Note: Single values are maximum.

(Continued)

Classification	Chemical composition (%)								
	C	Mn	Si	P	S	Ni	Cr	Mo	Others
E8015-B8L E8016-B8L E8018-B8L	0.05	1.0	0.90	0.03	0.03	0.40	8.0-10.5	0.85-1.20	-
E9015-B23 R9016-B23 E9018-B23	0.04-0.12	1.00	0.60	0.015	0.015	0.50	1.9-2.9	0.30	W: 1.50-2.00 V: 0.15-0.30 Nb: 0.02-0.10 B: 0.006 Al: 0.04 Cu: 0.25 N: 0.05
E9015-B24 E9016-B24 E9018-B24	0.04-0.12	1.00	0.60	0.020	0.015	0.50	1.9-2.9	0.80-1.20	V: 0.15-0.30 Nb: 0.02-0.10 Ti: 0.10 B: 0.006 Al: 0.04 Cu: 0.25 N: 0.07
E9015-B91 <sup>(1)</sup> E9016-B91 <sup>(1)</sup> E9018-B91 <sup>(1)</sup>	0.08-0.13	1.20	0.30	0.01	0.01	0.80	8.0-10.5	0.85-1.20	V: 0.15-0.30 Cu: 0.25 Al: 0.04 Nb: 0.02-0.10 N: 0.02-0.07
E9015-B92 E9016-B92 E9018-B92	0.08-0.15	1.20	0.60	0.020	0.015	1.00	8.0-10.0	0.30-0.70	W: 1.50-2.00 V: 0.15-0.30 Nb: 0.02-0.08 B: 0.006 Al: 0.04 Cu: 0.25 N: 0.03-0.08

Note: Single values are maximum. (1) Mn+Ni shall be 1.40% Max.

(Continued)



Classification	Chemical composition (%)								
	C	Mn	Si	P	S	Ni	Cr	Mo	Others
Ni steel electrodes									
E8016-C1	0.12	1.25	0.60	0.03	0.03	2.00-2.75	-	-	-
E8018-C1			0.80						
E7015-C1L	0.05	1.25	0.50	0.03	0.03	2.00-2.75	-	-	-
E7018-C1L									
E8016-C2	0.12	1.25	0.60	0.03	0.03	3.00-3.75	-	-	-
E8018-C2			0.80						
E7015-C2L	0.05	1.25	0.50	0.03	0.03	3.00-3.75	-	-	-
E7016-C2L									
E7018-C2L									
E8016-C3	0.12	0.40-1.25	0.80	0.03	0.03	0.80-1.10	0.15	0.35	V: 0.05
E8018-C3									
E7018-C3L	0.08	0.40-1.40	0.50	0.03	0.03	0.80-1.10	0.15	0.35	V: 0.05
E8016-C4	0.10	1.25	0.60	0.03	0.03	1.10-2.00	-	-	-
E8018-C4			0.80						
E9015-C5L	0.05	0.40-1.00	0.50	0.03	0.03	6.00-7.25	-	-	-
Ni-Mo steel electrodes									
E8018-NM1	0.10	0.80-1.25	0.60	0.02	0.02	0.80-1.10	0.10	0.40-0.65	V: 0.02 Cu: 0.10 Al: 0.05
E9018-NM2	0.04-0.15	0.50-1.60	0.70	0.02	0.02	1.40-2.10	0.20	0.20-0.50	V: 0.05 Cu: 0.10 Al: 0.05
Mn-Mo steel electrodes									
E8018-D1	0.12	1.00-1.75	0.80	0.03	0.03	0.90	-	0.25-0.45	-
E9015-D1			0.60						
E10015-D2	0.15	1.65-2.00	0.60	0.03	0.03	0.90	-	0.25-0.45	-
E10018-D2			0.80						
E8016-D3	0.12	1.00-1.80	0.60	0.03	0.03	0.90	-	0.40-0.65	-
E8018-D3			0.80						
E9018-D3									

(Continued)

Classification	Chemical composition (%)								
	C	Mn	Si	P	S	Ni	Cr	Mo	Others
General low-alloy steel electrodes									
EXX10-G <sup>(1)</sup>	-	1.00min.	0.80min.	0.03	0.03	0.50min.	0.30min.	0.20min.	V: 0.10min. Cu: 0.20min.
EXX11-G <sup>(1)</sup>									
EXX13-G <sup>(1)</sup>									
EXX15-G <sup>(1)</sup>									
EXX16-G <sup>(1)</sup>									
EXX18-G <sup>(1)</sup>									
E7020-G <sup>(1)</sup>									
E7027-G <sup>(1)</sup>									
Military-similar electrodes									
E9018-M	0.10	0.60-1.25	0.80	0.030	0.030	1.40-1.80	0.15	0.35	V: 0.05
E10018-M	0.10	0.75-1.70	0.60	0.030	0.030	1.40-2.10	0.35	0.25-0.50	V: 0.05
E11018-M	0.10	1.30-1.80	0.60	0.030	0.030	1.25-2.50	0.40	0.25-0.50	V: 0.05
E12018-M	0.10	1.30-2.25	0.60	0.030	0.030	1.75-2.50	0.30-1.50	0.30-0.55	V: 0.05
E12018-M1	0.10	0.80-1.60	0.65	0.015	0.012	3.00-3.80	0.65	0.20-0.30	V: 0.05
Pipeline steel electrodes									
E7010-P1 E8010-P1 E9010-P1	0.20	1.20	0.60	0.03	0.03	1.00	0.30	0.50	V: 0.10
E8018-P2 E9018-P2 E8045-P2 E9045-P2 E10045-P2	0.12	0.90-1.70	0.80	0.03	0.03	1.00	0.20	0.50	V: 0.05
Weathering steel electrodes									
E7018-W1	0.12	0.40-0.70	0.40-0.70	0.025	0.025	0.20-0.40	0.15-0.30	-	V: 0.08 Cu: 0.30-0.60
E8018-W2	0.12	0.50-1.30	0.35-0.80	0.03	0.03	0.40-0.80	0.45-0.70	-	Cu: 0.30-0.75

Note: Single values are maximum.

(1) The "G" group shall have the minimum of at least one of the elements listed in this table. The letters "XX" stand for various tensile strength levels of weld metal.

# AWS A5.4-2012

## Stainless Steel Electrodes for Shielded Metal Arc Welding

### Classification system

E ① ② [Ex.] E 308 - 15 E 309 L - 16

E: Stick electrodes

①: All-weld metal chemical composition and related requirements

Class.	Chemical composition of all-weld metal(%) <sup>(1) (2)</sup>											Mechanical properties of all-weld metal (As-welded)	
	C	Cr	Ni	Mo	Nb(Cb) +Ta	Mn	Si	P	S	N	Cu	TS, Min. (ksi)	El., Min. (%)
E209 *1	0.06	20.5-24.0	9.5-12.0	1.5-3.0	-	4.0-7.0	1.00	0.04	0.03	0.10-0.30	0.75	100	15
E219	0.06	19.0-21.5	5.5-7.0	0.75	-	8.0-10.0	1.00	0.04	0.03	0.10-0.30	0.75	90	15
E240	0.06	17.0-19.0	4.0-6.0	0.75	-	10.5-13.5	1.00	0.04	0.03	0.10-0.30	0.75	100	15
E307	0.04-0.14	18.0-21.5	9.0-10.7	0.5-1.5	-	3.30-4.75	1.00	0.04	0.03	-	0.75	85	30
E308	0.08	18.0-21.0	9.0-11.0	0.75	-	0.5-2.5	1.00	0.04	0.03	-	0.75	80	30
E308H	0.04-0.08	18.0-21.0	9.0-11.0	0.75	-	0.5-2.5	1.00	0.04	0.03	-	0.75	80	30
E308L	0.04	18.0-21.0	9.0-11.0	0.75	-	0.5-2.5	1.00	0.04	0.03	-	0.75	75	30
E308Mo	0.08	18.0-21.0	9.0-12.0	2.0-3.0	-	0.5-2.5	1.00	0.04	0.03	-	0.75	80	30
E308LMo	0.04	18.0-21.0	9.0-12.0	2.0-3.0	-	0.5-2.5	1.00	0.04	0.03	-	0.75	75	30
E309	0.15	22.0-25.0	12.0-14.0	0.75	-	0.5-2.5	1.00	0.04	0.03	-	0.75	80	30
E309H	0.04-0.15	22.0-25.0	12.0-14.0	0.75	-	0.5-2.5	1.00	0.04	0.03	-	0.75	80	30
E309L	0.04	22.0-25.0	12.0-14.0	0.75	-	0.5-2.5	1.00	0.04	0.03	-	0.75	75	30
E309Nb	0.12	22.0-25.0	12.0-14.0	0.75	0.70-1.00	0.5-2.5	1.00	0.04	0.03	-	0.75	80	30
E309Mo	0.12	22.0-25.0	12.0-14.0	2.0-3.0	-	0.5-2.5	1.00	0.04	0.03	-	0.75	80	30
E309LMo	0.04	22.0-25.0	12.0-14.0	2.0-3.0	-	0.5-2.5	1.00	0.04	0.03	-	0.75	75	30
E310	0.08-0.20	25.0-28.0	20.0-22.5	0.75	-	1.0-2.5	0.75	0.03	0.03	-	0.75	80	30
E310H	0.35-0.45	25.0-28.0	20.0-22.5	0.75	-	1.0-2.5	0.75	0.03	0.03	-	0.75	90	10
E310Nb	0.12	25.0-28.0	20.0-22.0	0.75	0.70-1.00	1.0-2.5	0.75	0.03	0.03	-	0.75	80	25
E310Mo	0.12	25.0-28.0	20.0-22.0	2.0-3.0	-	1.0-2.5	0.75	0.03	0.03	-	0.75	80	30
E312	0.15	28.0-32.0	8.0-10.5	0.75	-	0.5-2.5	1.00	0.04	0.03	-	0.75	95	22
E316	0.08	17.0-20.0	11.0-14.0	2.0-3.0	-	0.5-2.5	1.00	0.04	0.03	-	0.75	75	30
E316H	0.04-0.08	17.0-20.0	11.0-14.0	2.0-3.0	-	0.5-2.5	1.00	0.04	0.03	-	0.75	75	30
E316L	0.04	17.0-20.0	11.0-14.0	2.0-3.0	-	0.5-2.5	1.00	0.04	0.03	-	0.75	70	30
E316Mn	0.04	18.0-21.0	15.0-18.0	2.5-3.5	-	5.0-8.0	0.90	0.04	0.03	0.10-0.25	0.75	80	20

Note: \*1 V: 0.10~0.30

(Continued)

Class.	Chemical composition of all-weld metal(%) <sup>(1) (2)</sup>											Mechanical properties of all-weld metal (As-welded)	
	C	Cr	Ni	Mo	Nb(Cb) +Ta	Mn	Si	P	S	N	Cu	TS, Min. (ksi)	El., Min. (%)
E317	0.08	18.0-21.0	12.0-14.0	3.0-4.0	-	0.5-2.5	1.00	0.04	0.03	-	0.75	80	30
E317L	0.04	18.0-21.0	12.0-14.0	3.0-4.0	-	0.5-2.5	1.00	0.04	0.03	-	0.75	75	30
E318	0.08	17.0-20.0	11.0-14.0	2.0-3.0	6xC-1.00	0.5-2.5	1.00	0.04	0.03	-	0.75	80	25
E320	0.07	19.0-21.0	32.0-36.0	2.0-3.0	8xC-1.00	0.5-2.5	0.60	0.04	0.03	-	3.0-4.0	80	30
E320LR	0.03	19.0-21.0	32.0-36.0	2.0-3.0	8xC-0.40	1.50-2.50	0.30	0.020	0.015	-	3.0-4.0	75	30
E330	0.18-0.25	14.0-17.0	33.0-37.0	0.75	-	1.0-2.5	1.00	0.04	0.03	-	0.75	75	25
E330H	0.35-0.45	14.0-17.0	33.0-37.0	0.75	-	1.0-2.5	1.00	0.04	0.03	-	0.75	90	10
E347	0.08	18.0-21.0	9.0-11.0	0.75	8xC-1.00	0.5-2.5	1.00	0.04	0.03	-	0.75	75	30
E349 *2	0.13	18.0-21.0	8.0-10.0	0.35-0.65	0.75-1.20	0.5-2.5	1.00	0.04	0.03	-	0.75	100	25
E383	0.03	26.5-29.0	30.0-33.0	3.2-4.2	-	0.5-2.5	0.90	0.02	0.02	-	0.6-1.5	75	30
E385	0.03	19.5-21.5	24.0-26.0	4.2-5.2	-	1.0-2.5	0.90	0.03	0.02	-	1.2-2.0	75	30

Note: \*2 V: 0.10~0.30, Ti: 0.15max, W: 1.25~1.75

Class.	Chemical composition of all-weld metal (%) <sup>(1) (2)</sup>										Mechanical properties of all-weld metal <sup>(3)</sup>		
	C	Cr	Ni	Mo	Nb(Cb) +Ta	Mn	Si	P	S	Cu	TS, Min (ksi)	El., Min. (%)	PWHT
E409Nb	0.12	11.0-14.0	0.6	0.75	0.50-1.50	1.0	1.00	0.04	0.03	0.75	65	20	c
E410	0.12	11.0-13.5	0.7	0.75	-	1.0	0.90	0.04	0.03	0.75	65	20	a
E410NiMo	0.06	11.0-12.5	4.0-5.0	0.40-0.70	-	1.0	0.90	0.04	0.03	0.75	110	15	b
E430	0.10	15.0-18.0	0.6	0.75	-	1.0	0.90	0.04	0.03	0.75	65	20	c
E430Nb	0.10	15.0-18.0	0.6	0.75	0.50-1.50	1.0	1.00	0.04	0.03	0.75	65	20	c
E630	0.05	16.00-16.75	4.5-5.0	0.75	0.15-0.30	0.25-0.75	0.75	0.04	0.03	3.25-4.00	135	7	d
E16-8-2	0.10	14.5-16.5	7.5-9.5	1.0-2.0	-	0.5-2.5	0.60	0.03	0.03	0.75	80	35	None

Class.	Chemical composition of all-weld metal(%) <sup>(1) (2)</sup>												Mechanical properties of all-weld metal <sup>(3)</sup>		
	C	Cr	Ni	Mo	Nb(Cb) +Ta	Mn	Si	P	S	N	Cu	Others	TS, Min (ksi)	El., Min. (%)	PWHT
E2209	0.04	21.5-23.5	8.5-10.5	2.5-3.5	-	0.5-2.0	1.00	0.04	0.03	0.08-0.20	0.75	-	100	20	None
E2307	0.04	22.5-25.5	6.5-10.0	0.8	-	0.4-1.5	1.0	0.030	0.020	0.10-0.20	0.50	-	100	20	None
E2553	0.06	24.0-27.0	6.5-8.5	2.9-3.9	-	0.5-1.5	1.0	0.04	0.03	0.10-0.25	1.5-2.5	-	110	15	None
E2593	0.04	24.0-27.0	8.5-10.5	2.9-3.9	-	0.5-1.5	1.00	0.04	0.03	0.08-0.25	1.5-3.0	-	110	15	None
E2594	0.04	24.0-27.0	8.0-10.5	3.5-4.5	-	0.5-2.0	1.00	0.04	0.03	0.20-0.30	0.75	-	110	15	None
E2595	0.04	24.0-27.0	8.0-10.5	2.5-4.5	-	2.5	1.2	0.03	0.025	0.20-0.30	0.4-1.5	W: 0.4-1.0	110	15	None
E3155	0.10	20.0-22.5	19.0-21.0	2.5-3.5	0.75- 1.25	1.0-2.5	1.00	0.04	0.03	-	0.75	Co: 18.5-21.0 W: 2.0-3.0	100	20	None
E33-31	0.03	31.0-35.0	30.0-32.0	1.0-2.0	-	2.5-4.0	0.9	0.02	0.01	0.3-0.5	0.4-0.8	-	105	25	None

Note: (1) Single values are maximum.

(2) The total of other elements, except iron, shall not present in excess of 0.5%.

(3) All-weld-metal mechanical properties are obtained after the following PWHT:

- a: Heat to 1350 to 1400°F (730 to 760°C), hold for one hour, furnace cool at a rate not to exceed 200°F (110°C) per hour to 600°F (315°C) and air cool to ambient.
- b: Heat to 1100 to 1150°F (595 to 620°C), hold for one hour, and air cool to ambient.
- c: Heat to 1400 to 1450°F (760 to 790°C), hold for two hours, furnace cool at a rate not exceeding 100°F (55°C) per hour to 1100°F (595°C) and air cool to ambient.
- d: Heat to 1875 to 1925°F (1025 to 1050°C), hold for one hour, and air cool to ambient, and then precipitation harden at 1135 to 1165°F (610 to 630°C), hold for four hours, and air cool to ambient.

②: Type of current and welding position

Classification suffix	Type of current	Welding position
-15	DCEP	All
-16	DCEP and AC	All
-17	DCEP and AC	All
-26	DCEP and AC	F, H-Fil

## Nickel and Nickel Alloy Welding Electrodes for Shielded Metal Arc Welding

### Classification system

E ① [Ex.] E NiCu-7

E: Stick electrodes

①: Chemical composition of all-weld metal

Class.	Wt % <sup>(1)</sup>															
	C	Mn	Fe	P	S	Si	Cu	Ni <sup>(2)</sup>	Co	Al	Ti	Cr	Nb(Cb) +Ta	Mo	V	W
ENi-1	0.10	0.75	0.75	0.03	0.02	1.25	0.25	≥92.0	-	1.0	1.0-4.0	-	-	-	-	-
ENiCr-4	0.10	1.5	1.0	0.02	0.02	1.0	0.25	Bal	-	-	-	48.0-52.0	1.0-2.5	-	-	-
ENiCu-7	0.15	4.0	2.5	0.02	0.015	1.5	Bal	62.0-69.0	-	0.75	1.0	-	-	-	-	-
ENiCrFe-1	0.08	3.5	11.0	0.03	0.015	0.75	0.50	≥62.0	-	-	-	13.0-17.0	1.5-4.0 <sup>(4)</sup>	-	-	-
ENiCrFe-2	0.10	1.0-3.5	12.0	0.03	0.02	0.75	0.50	≥62.0	<sup>(3)</sup>	-	-	13.0-17.0	0.5-3.0 <sup>(4)</sup>	0.5-2.5	-	-
ENiCrFe-3	0.10	5.0-9.5	10.00	0.03	0.015	1.0	0.50	≥59.0	<sup>(3)</sup>	-	1.0	13.0-17.0	1.0-2.5 <sup>(4)</sup>	-	-	-
ENiCrFe-4	0.20	1.0-3.5	12.00	0.03	0.02	1.0	0.50	≥60.0	-	-	-	13.0-17.0	1.0-3.5	1.0-3.5	-	-
ENiCrFe-7 <sup>(5)</sup>	0.05	5.0	7.0-12.0	0.03	0.015	0.75	0.50	Bal	<sup>(3)</sup>	0.50	0.50	28.0-31.5	1.0-2.5	0.5	-	-
ENiCrFe-9	0.15	1.0-4.5	12.00	0.02	0.015	0.75	0.50	≥55.0	-	-	-	12.0-17.0	0.5-3.0	2.5-5.5	-	1.5
ENiCrFe-10	0.20	1.0-3.5	12.00	0.02	0.015	0.75	0.50	≥55.0	-	-	-	13.0-17.0	1.0-3.5	1.0-3.5	-	1.5-3.5
ENiCrFe-12	0.10-0.25	1.0	8.0-11.0	0.04	0.02	1.0	0.20	Bal	1.0	1.5-2.2	0.10-0.40	24.0-26.0	-	-	-	-
ENiCrFe-13 <sup>(7)</sup>	0.05	1.0	Bal	0.020	0.015	0.75	0.30	52.0-62.0	0.10	0.50	0.50	28.5-31.0	2.1-4.0	3.0-5.0	-	-
ENiCrFeSi-1	0.05-0.20	2.5	21.0-25.0	0.04	0.03	2.5-3.0	0.30	Bal	1.0	0.30	-	26.0-29.0	-	-	-	-
ENiMo-1	0.07	1.0	4.0-7.0	0.04	0.03	1.0	0.50	Bal	2.5	-	-	1.0	-	26.0-30.0	0.60	1.0
ENiMo-3	0.12	1.0	4.0-7.0	0.04	0.03	1.0	0.50	Bal	2.5	-	-	2.5-5.5	-	23.0-27.0	0.60	1.0
ENiMo-7	0.02	1.75	2.25	0.04	0.03	0.2	0.50	Bal	1.0	-	-	1.0	-	26.0-30.0	-	1.0
ENiMo-8	0.10	1.5	10.0	0.02	0.015	0.75	0.50	≥60.0	-	-	-	0.5-3.5	-	17.0-20.0	-	2.0-4.0
ENiMo-9	0.10	1.5	7.0	0.02	0.015	0.75	0.3-1.3	≥62.0	-	-	-	-	-	18.0-22.0	-	2.0-4.0
ENiMo-10	0.02	2.0	1.0-3.0	0.04	0.03	0.2	0.50	Bal	3.0	-	-	1.0-3.0	-	27.0-32.0	-	3.0
ENiMo-11	0.02	2.5	2.0-5.0	0.04	0.03	0.2	0.5	Bal	1.0	0.1-0.5	0.3	0.5-1.5	0.5	26.0-30.0	-	-
ENiCrMo-1	0.05	1.0-2.0	18.0-21.0	0.04	0.03	1.0	1.5-2.5	Bal	2.5	-	-	21.0-23.5	1.75-2.50	5.5-7.5	-	1.0

(Continued)

Class.	Wt % <sup>(1)</sup>															
	C	Mn	Fe	P	S	Si	Cu	Ni <sup>(2)</sup>	Co	Al	Ti	Cr	Nb(Cb) +Ta	Mo	V	W
ENiCrMo-2	0.05-0.15	1.0	17.0-20.0	0.04	0.03	1.0	0.50	Bal	0.50-2.50	-	-	20.5-23.0	-	8.0-10.0	-	0.2-1.0
ENiCrMo-3	0.10	1.0	7.0	0.03	0.02	0.75	0.50	≥55.0	<sup>(3)</sup>	-	-	20.0-23.0	3.15-4.15	8.0-10.0	-	-
ENiCrMo-4	0.02	1.0	4.0-7.0	0.04	0.03	0.2	0.50	Bal	2.5	-	-	14.5-16.5	-	15.0-17.0	0.35	3.0-4.5
ENiCrMo-5	0.10	1.0	4.0-7.0	0.04	0.03	1.0	0.50	Bal	2.5	-	-	14.5-16.5	-	15.0-17.0	0.35	3.0-4.5
ENiCrMo-6	0.10	2.0-4.0	10.0	0.03	0.02	1.0	0.50	≥55.0	-	-	-	12.0-17.0	0.5-2.0	5.0-9.0	-	1.0-2.0
ENiCrMo-7	0.015	1.5	3.0	0.04	0.03	0.2	0.50	Bal	2.0	-	0.70	14.0-18.0	-	14.0-17.0	-	0.5
ENiCrMo-9	0.02	1.0	18.0-21.0	0.04	0.03	1.0	1.5-2.5	Bal	5.0	-	-	21.0-23.5	0.5	6.0-8.0	-	1.5
ENiCrMo-10	0.02	1.0	2.0-6.0	0.03	0.015	0.2	0.50	Bal	2.5	-	-	20.0-22.5	-	12.5-14.5	0.35	2.5-3.5
ENiCrMo-11	0.03	1.5	13.0-17.0	0.04	0.02	1.0	1.0-2.4	Bal	5.0	-	-	28.0-31.5	0.3-1.5	4.0-6.0	-	1.5-4.0
ENiCrMo-12	0.03	2.2	5.0	0.03	0.02	0.7	0.50	Bal	-	-	-	20.5-22.5	1.0-2.8	8.8-10.0	-	-
ENiCrMo-13	0.02	1.0	1.5	0.015	0.01	0.2	0.50	Bal	-	-	-	22.0-24.0	-	15.0-16.5	-	-
ENiCrMo-14	0.02	1.0	5.0	0.02	0.02	0.25	0.50	Bal	-	-	0.25	19.0-23.0	-	15.0-17.0	-	3.0-4.4
ENiCrMo-17	0.020	0.5	3.0	0.030	0.015	0.2	1.3-1.9	Bal	2.0	-	-	22.0-24.0	-	15.0-17.0	-	-
ENiCrMo-18	0.03	0.7	12.0-15.0	0.03	0.02	0.6	0.3	Bal	1.0	0.5	-	19.0-22.0	0.3	10.0-13.0	0.15	1.0-2.0
ENiCrMo-19 <sup>(6)</sup>	0.02	1.5	1.5	0.03	0.02	0.2	0.5	Bal	0.3	0.4	-	20.0-23.0	-	19.0-21.0	-	0.3
ENiCrMo-22	0.05	0.50	2.00	0.030	0.015	0.60	0.30	Bal	1.00	0.40	0.20	32.25-34.25	0.50	7.0-9.0	0.20	0.60
ENiCrCoMo-1	0.05-0.15	0.3-2.5	5.0	0.03	0.015	0.75	0.50	Bal	9.0-15.0	-	-	21.0-26.0	1.0	8.0-10.0	-	-
ENiCrWMo-1	0.05-0.10	0.3-1.0	3.0	0.02	0.015	0.25-0.75	0.50	Bal	5.0	0.50	0.10	20.0-24.0	-	1.0-3.0	-	13.0-15.0

Note: (1) Single values are maximum. The total of other elements shall not be in excess of 0.50%.

(2) Includes incidental cobalt.

(3) Cobalt—0.12 maximum, when specified by the purchaser.

(4) Tantalum—0.30 maximum, when specified by the purchaser.

(5) Boron is 0.005% maximum and Zr is 0.020% maximum when specified by the purchaser.

(6) N = 0.02-0.15%.

(7) Bis 0.003% max. and Zr is 0.020% max.

# AWS A5.15-2006

## Welding Electrodes and Rods for Cast Iron

### Classification system

E ① [Ex.] E NiFe-CI

E: Electrodes for SMAW or FCAW

①: Chemical composition requirements

Classification	Chemical composition (%) <sup>(1)</sup>										
	C	Mn	Si	P	S	Fe	Ni <sup>(2)</sup>	Mo	Cu <sup>(3)</sup>	Al	Others
All-weld metal											
ENi-CI	2.0	2.5	4.0	-	0.03	8.0	≥85	-	2.5	1.0	1.0
ENi-CI-A	2.0	2.5	4.0	-	0.03	8.0	≥85	-	2.5	1.0-3.0	1.0
ENiFe-CI	2.0	2.5	4.0	-	0.03	Bal	45-60	-	2.5	1.0	1.0
ENiFe-CI-A	2.0	2.5	4.0	-	0.03	Bal	45-60	-	2.5	1.0-3.0	1.0
ENiFeMn-CI	2.0	10-14	1.0	-	0.03	Bal	35-45	-	2.5	1.0	1.0
ENiCu-A	0.35-0.55	2.3	0.75	-	0.025	3.0-6.0	50-60	-	35-45	-	1.0
ENiCu-B	0.35-0.55	2.3	0.75	-	0.025	3.0-6.0	60-70	-	25-35	-	1.0
ENiFeT3-CI <sup>(4)</sup>	2.0	3.0-5.0	1.0	-	0.03	Bal	45-60	-	2.5	1.0	1.0
Core wire											
ESt	0.15	0.60	0.15	0.04	0.04	Bal	-	-	-	-	-

Note : (1) Single values are maximum.

(2) Nickel plus incidental cobalt.

(3) Copper plus incidental silver.

(4) No shielding gas shall be used for ENiFeT3-CI.



# AWS A5.17-2007, A5.23-2011

## A5.17: Carbon Steel Electrodes and Fluxes for Submerged Arc Welding A5.23: Low Alloy Steel Electrodes and Fluxes for Submerged Arc Welding

F ① ② ③ – ④ ⑤ – ⑥ [Ex.] F 6 A 0 – E H14  
F 9 A2 – EC M1 – M1

F: Submerged arc welding flux

①: Tension test requirements of all-weld metal<sup>(1)</sup>

A5.17 A5.23 Code	TS (ksi)	YS (ksi)	El., Min. (%)
6	60-80	48	22
7	70-95	58	22
8	80-100	68	20
9	90-110	78	17
10	100-120	88	16
11	110-130	98	15
12	120-140	108	14
13	130-150	118	14

③: Impact test requirements<sup>(1)</sup>

A5.17 A5.23 Code	Temp. (°F)	IV, Min. (ft-lbf)
Z	-	None
0	0	Av. 20 Each 15
2	-20	
4	-40	
5	-50	
6	-60	
8	-80	
10	-100	
15	-150	

Note (1) PWHT is specified depending on classification for tension and impact testing.

②: Heat treatment

Code	Designation
A	As-welded
P	PWHT

④: Type of electrode

Code	Designation
E	Solid
EC	Composite

⑤: Chemical composition of wire

Code	Type	Code	Type	Code	Type
L8 L8K L12	Low Mn	A1 A2 A3 A3K A4	Mo	Ni1 Ni1K Ni2 Ni3 Ni4 Ni5 Ni6	Ni
M11K M12 M12K M13K M14K M15K	Medium Mn	B1 B2 B2H B3 B5 B6 B6H B8	Cr-Mo	F1 F2 F3 F4 F5 F6	Other alloying
H10K H11K H12K H14	High Mn			M1 M2 M3 M4 M5 M6 W G	
G			Not Specified		

⑥: Chemical composition of weld metal

Code	Type	Code	Type
A1 A2 A3 A4	Mo	Ni1 Ni2 Ni3 Ni4 Ni5	Ni
B1 B2 B2H B3 B4 B5 B6 B6H B8	Cr-Mo	F1 F2 F3 F4 F5 F6 M1 M2 M3 M4 M5 M6 W G	Other alloying

# AWS A5.18-2005, A5.28-2005

## A5.18: Carbon Steel Electrodes and Rods for Gas Shielded Arc Welding A5.28: Low-Alloy Steel Electrodes and Rods for Gas Shielded Arc Welding

### Classification system

ER (or E) ① ② – ③ ④ ⑤

A5.18: [Ex.] ER 70 S – 2, E 70 C – 3 M, E 70 C – 3 M H16

A5.28: ER 80 S – B2, E 80 C – B2 H16

ER: Electrode or rod

E: Electrode

①: All-weld metal tensile strength and related requirements <sup>(1)</sup>

Code	TS, Min. (ksi)	El., Min. (%)	IV, <sup>(2)</sup> Min. (ft-lb)
70	70 75 (A5.28)	14-24 according to classification	Average 20 Each 15 at specific temperature
80	80		
90	90		
100	100		
110	110		
120	120		

Note (1) PWHT is specified depending on classification.

(2) Not required for Mo and Cr-Mo type filler wires.

③: Chemical composition of wire or all-weld metal (A 5.18)

Class.	Suffix	Shielding gas	Type
ER 70 S	2	CO <sub>2</sub>	Carbon steel
ER 70 S	3		
ER 70 S	4		
ER 70 S	6		
ER 70 S	7		
ER 70 S	G	<sup>(2)</sup>	
E 70 C	3	75-80%Ar/ bal.CO <sub>2</sub> or CO <sub>2</sub>	
E 70 C	6		
E 70 C	G	<sup>(2)</sup>	
E 70 C	GS <sup>(1)</sup>		

Note : (1) For single pass

(2) As agreed upon between purchaser and supplier

②: Type of electrode

Code	Designation
S	Solid
C	Composite

④: Type of shielding gas (A 5.18)

Code	Designation
C	CO <sub>2</sub>
M	Ar-20-25%CO <sub>2</sub>

⑤: Diffusible hydrogen (Option) (A 5.18)

Code	ml/100g deposited metal
H16	16.0max.
H8	8.0max.
H4	4.0max.

③: Chemical composition of wire or all-weld metal (A 5.28)

Class.	Suffix	Shielding gas	Type of steel
ER 70 S	A1	Ar/1-5%O <sub>2</sub>	C-0.5Mo
E 90 C	D2	Ar/1-5%O <sub>2</sub>	1.5Mn-0.5Mo
ER 80 S ER 70 S E 70 C E 80 C	B2 B2L B2L B2	Ar/1-5%O <sub>2</sub>	1.25Cr-0.5Mo
ER 90 S ER 80 S E 80 C E 90 C	B3 B3L B3L B3	Ar/1-5%O <sub>2</sub>	2.25Cr-1Mo
ER 80 S E 80 C	B6	Ar/1-5%O <sub>2</sub>	5Cr-0.5Mo
ER 80 S E 80 C	B8	Ar/1-5%O <sub>2</sub>	9Cr-1Mo
ER 90 S E 90 C	B9	Ar/5%O <sub>2</sub>	9Cr-1Mo-0.2V
ER 80 S E 80 C ER 80 S E 70 C E 80 C ER 80 S E 80 C	Ni1 Ni1 Ni2 Ni2 Ni2 Ni3 Ni3	Ar/1-5%O <sub>2</sub>	Ni
ER 80 S	D2	CO <sub>2</sub>	Mn-Mo
ER 90 S E 90 C	D2	Ar/1-5%O <sub>2</sub>	
ER 100 S ER 110 S ER 120 S	1 1 1	Ar/2%O <sub>2</sub>	Other low alloy
ER xx S E xx C	G <sup>(1)</sup>	<sup>(1)</sup>	Not specified <sup>(2)</sup>

④: Diffusible hydrogen (Option) (A 5.28)

Additional Designation	ml/100g deposited metal
H16	16.0max.
H8	8.0max.
H4	4.0max.
H2	2.0max.

Note: (1) As agreed upon between purchaser and supplier.

# AWS A5.20-2005, A5.29-2010

## A5.20: Carbon Steel Electrodes for Flux Cored Arc Welding A5.29: Low Alloy Electrodes for Flux Cored Arc Welding

### Classification system

A 5.20 : E ① ② T - ③ ④ - J HZ [Ex.] E 7 1 T - 1 M - J H8

A 5.29 : E ① ② T - ③ - ⑤ ④ - J HZ [Ex.] E 8 1 T 1 - B2 M - J H8

E: Electrodes

①: All-weld metal tensile strength and related requirements<sup>(1)</sup>

Code	TS (ksi)	IV, Min. (ft-lbf)
6	60-80	Average 20 Each 15 at specific temperature
7	70-90	
8	80-100	
9	90-110	
10	100-120	
11	110-130	
12	120-140	

Note: (1) PWHT is required depending on classification

②: Welding position ④: Shielding gas

Code	Designation	Suffix	Designation
0	F, H-Fil	M	75-80%Ar/Bal.
1	All positions	C	CO <sub>2</sub>
		None	Self-shield

⑤: Chemical composition of all-weld metal (A 5.29)

Suffix	Type	Suffix	Type
A1	C-Mo	Ni1	Ni
B1	Cr-Mo	Ni2	
B1L		Ni3	
B2		D1	Mn-Mo
B2L		D2	
B2L		D3	
B2H		Other low-alloy	K1
B3			K2
B3L			K3
B3H			K4
B6			K5
B6L	K6		
B6L	K7		
B8	K8		
B8L	K9		
B9	W2		
	G		

T: Flux-cored electrodes

③: Usability designator

Suffix <sup>(1)</sup>	Performances (Polarity, Application)
1	MAG, Fillet welding (Multi-pass)
2	MAG, Fillet welding (Single pass)
3	Self-shielded, DC-EP, High welding speed
4	Self-shielded, DC-EP, High deposition rate
5	MAG, High impact value, Good crack resistance
6	Self-shielded, DC-EP, High impact value
7	Self-shielded, DC-EN, High deposition rate
8	Self-shielded, DC-EN, High deposition rate
9	MAG, DC-EP, Small size: for all positions
10	Self-shielded, DC-EN, High welding speed
11	Self-shielded, DC-EN, Good usability
12	MAG, DC-EP, High impact value
13	Self-shielded, DC-EN, Root pass welding of pipes
14	Self-shielded, DC-EN, All positions, High welding speed
G	Not specified, For multiple-pass welding
GS	Not specified, For single-pass welding

Note: (1) A 5.29 designates 1, 4, 5, 6, 7, 8, 11 or G only.

[Option]

J : Satisfies the minimum impact value 27J at -40°C (A5.20) or at a test temperature of 11°C lower (A5.29) than the specified temperature

HZ : Diffusible hydrogen

Suffix	Diffusible hydrogen, ml/100g deposited metal
H16	16.0max.
H8	8.0max.
H4	4.0max.
None <sup>(1)</sup>	8.0max.

Note (1) A 5.29 only

# AWS A5.26-1997

## Carbon and Low Alloy Steel Electrodes for Electrogas Welding

### Classification system

EG ① ② ③

[Ex.] EG 6 0 T (or S) 1

EG: Electrogas welding electrodes

T: Cored electrodes

S: Solid electrodes

①: Tensile strength of all-weld metal

Code	TS (ksi)
6	60-80
7	70-95
8	80-100

②: Impact value of all-weld metal

Code	Temp. (°F)	(ft-lbf)
Z	Not specified	
0	0	20
2	-20	20

③: Chemical composition

Class	Suffix	Chemical composition of solid wire (%) <sup>(1)</sup>											
		C	Mn	S	P	Si	Ni	Mo	Cu	Ti	Zr	Al	Others
EGXXS	1	0.07-0.19	0.90-1.40	0.035	0.025	0.30-0.50	-	-	0.35	-	-	-	0.50
	2	0.07	0.90-1.40	0.035	0.025	0.40-0.70	-	-	0.35	0.05-0.15	0.02-0.12	0.05-0.15	0.50
	3	0.06-0.15	0.90-1.40	0.035	0.025	0.45-0.75	-	-	0.35	-	-	-	0.50
	5	0.07-0.19	0.90-1.40	0.035	0.025	0.30-0.60	-	-	0.35	-	-	0.50-0.90	0.50
	6	0.06-0.15	1.40-1.85	0.035	0.025	0.80-1.15	-	-	0.35	-	-	-	0.50
	D2	0.07-0.12	1.60-2.10	0.035	0.025	0.50-0.80	0.15	0.40-0.60	0.35	-	-	-	0.50
	G	Not specified											

Note : (1) Single values are maximum.

Class.	Suffix	Shielding gas	Chemical composition of all-weld metal (%) <sup>(1)</sup>										
			C	Mn	P	S	Si	Ni	Cr	Mo	Cu	V	Others
EG6XT	1	None	<sup>(2)</sup>	1.7	0.03	0.03	0.50	0.30	0.20	0.35	0.35	0.08	0.50
EG7XT	1	None	<sup>(2)</sup>	1.7	0.03	0.03	0.50	0.30	0.20	0.35	0.35	0.08	0.50
EG8XT	1	None	<sup>(2)</sup>	1.8	0.03	0.03	0.90	0.30	0.20	0.25-0.65	0.35	0.08	0.50
EG6XT	2	CO <sub>2</sub>	<sup>(2)</sup>	2.0	0.03	0.03	0.90	0.30	0.20	0.35	0.35	0.08	0.50
EG7XT	2	CO <sub>2</sub>	<sup>(2)</sup>	2.0	0.03	0.03	0.90	0.30	0.20	0.35	0.35	0.08	0.50
EGXXT	Ni1	CO <sub>2</sub>	0.10	1.0-1.8	0.03	0.03	0.50	0.70-1.10	-	0.30	0.35	-	0.50
EGXXT	NM1	Ar-CO <sub>2</sub> or CO <sub>2</sub>	0.12	1.0-2.0	0.02	0.03	0.15-0.50	1.5-2.0	0.20	0.40-0.65	0.35	0.05	0.50
EGXXT	NM2	CO <sub>2</sub>	0.12	1.1-2.1	0.03	0.03	0.20-0.60	1.1-2.0	0.20	0.10-0.35	0.35	0.05	0.50
EGXXT	W	CO <sub>2</sub>	0.12	0.50-1.3	0.03	0.03	0.30-0.80	0.40-0.80	0.45-0.70	-	0.30-0.75	-	0.50
EGXXT	G	Not specified											

Note : (1) Single values are maximum.

(2) Composition range of carbon not specified for these classifications, but the amount shall be determined and reported.

# AWS A5.22-2012

## Stainless Steel Flux Cored and Metal Cored Welding Electrodes and Rods

### Classification system

E ① T ② - ③ [Ex.] E 308L T 1 - 1  
 R ① T ② - ③ [Ex.] R 308L T 1 - 5  
 EC ① [Ex.] EC308L

E: Welding electrodes

R: Welding rods

EC: Metal cored electrodes

T: Flux-core electrodes or rods

①: All weld metal composition and related requirements (See A5.22 for self-shielded wires)

Class.	Chemical composition (%) <sup>(1) (2)</sup>										Mechanical properties (As-welded)	
	C	Cr	Ni	Mo	Nb+Ta	Mn	Si	P	S	Cu	TS, Min (ksi)	El., Min. (%)
E307	0.13	18.0-20.5	9.0-10.5	0.5-1.5	-	3.30-4.75	1.0	0.04	0.03	0.75	85	30
E308	0.08	18.0-21.0	9.0-11.0	0.75	-	0.5-2.5	1.0	0.04	0.03	0.75	80	30
E308H	0.04-0.08	18.0-21.0	9.0-11.0	0.75	-	0.5-2.5	1.0	0.04	0.03	0.75	80	30
E308L	0.04	18.0-21.0	9.0-11.0	0.75	-	0.5-2.5	1.0	0.04	0.03	0.75	75	30
E308Mo	0.08	18.0-21.0	9.0-11.0	2.0-3.0	-	0.5-2.5	1.0	0.04	0.03	0.75	80	30
E308LMo	0.04	18.0-21.0	9.0-12.0	2.0-3.0	-	0.5-2.5	1.0	0.04	0.03	0.75	75	30
E309	0.10	22.0-25.0	12.0-14.0	0.75	-	0.5-2.5	1.0	0.04	0.03	0.75	80	30
E309H	0.04-0.10	22.0-25.0	12.0-14.0	0.75	-	0.5-2.5	1.0	0.04	0.03	0.75	80	30
E309L	0.04	22.0-25.0	12.0-14.0	0.75	-	0.5-2.5	1.0	0.04	0.03	0.75	75	30
E309Mo	0.12	21.0-25.0	12.0-16.0	2.0-3.0	-	0.5-2.5	1.0	0.04	0.03	0.75	80	25
E309LMo	0.04	21.0-25.0	12.0-16.0	2.0-3.0	-	0.5-2.5	1.0	0.04	0.03	0.75	75	25
E309LNiMo	0.04	20.5-23.5	15.0-17.0	2.5-3.5	-	0.5-2.5	1.0	0.04	0.03	0.75	75	25
E309LNb	0.04	22.0-25.0	12.0-14.0	0.75	0.70-1.00	0.5-2.5	1.0	0.04	0.03	0.75	75	30
E310	0.20	25.0-28.0	20.0-22.5	0.75	-	1.0-2.5	1.0	0.03	0.03	0.75	80	30
E312	0.15	28.0-32.0	8.0-10.5	0.75	-	0.5-2.5	1.0	0.04	0.03	0.75	95	22
E316	0.08	17.0-20.0	11.0-14.0	2.0-3.0	-	0.5-2.5	1.0	0.04	0.03	0.75	75	30
E316H	0.04-0.08	17.0-20.0	11.0-14.0	2.0-3.0	-	0.5-2.5	1.0	0.04	0.03	0.75	75	30
E316L	0.04	17.0-20.0	11.0-14.0	2.0-3.0	-	0.5-2.5	1.0	0.04	0.03	0.75	70	30
E317L	0.04	18.0-21.0	12.0-14.0	3.0-4.0	-	0.5-2.5	1.0	0.04	0.03	0.75	75	20
E347	0.08	18.0-21.0	9.0-11.0	0.75	8xC-1.0	0.5-2.5	1.0	0.04	0.03	0.75	75	30
E347H	0.04-0.08	18.0-21.0	9.0-11.0	0.75	8xC-1.0	0.5-2.5	1.0	0.04	0.03	0.75	75	30
R308L	0.03	18.0-21.0	9.0-11.0	0.75	-	0.5-2.5	1.2	0.04	0.03	0.75	75	30
R309L	0.03	22.0-25.0	12.0-14.0	0.75	-	0.5-2.5	1.2	0.04	0.03	0.75	75	30
R316L	0.03	17.0-20.0	11.0-14.0	2.0-3.0	-	0.5-2.5	1.2	0.04	0.03	0.75	70	30
R347	0.08	18.0-21.0	9.0-11.0	0.75	8xC-1.0	0.5-2.5	1.2	0.04	0.03	0.75	75	30
EC308L	0.03	19.5-22.0	9.0-11.0	0.75	-	1.0-2.5	0.30-0.65	0.03	0.03	0.75	-	-
EC309L	0.03	23.0-25.0	12.0-14.0	0.75	-	1.0-2.5	0.30-0.65	0.03	0.03	0.75	-	-
EC316L	0.03	18.0-20.0	11.0-14.0	2.0-3.0	-	1.0-2.5	0.30-0.65	0.03	0.03	0.75	-	-
EC309LMo	0.03	23.0-25.0	12.0-14.0	2.0-3.0	-	1.0-2.5	0.30-0.65	0.03	0.03	0.75	-	-

(Continued)

Class.	Chemical composition (%) <sup>(1) (2)</sup>										Mechanical properties <sup>(3)</sup>		
	C	Cr	Ni	Mo	Nb+Ta	Mn	Si	P	S	Cu	TS, Min (ksi)	El., Min. (%)	PWHT
E409	0.10	10.5-13.5	0.60	0.75	-	0.80	1.0	0.04	0.03	0.75	65	15	None
E409Nb	0.10	10.5-13.5	0.6	1.2	8XC-1.5	0.80	1.0	0.04	0.03	0.5	65	15	(c)
E410	0.12	11.0-13.5	0.60	0.75	-	1.2	1.0	0.04	0.03	0.75	75	20	(a)
E410NiMo	0.06	11.0-12.5	4.0-5.0	0.40-0.70	-	1.0	1.0	0.04	0.03	0.75	110	15	(b)
E430	0.10	15.0-18.0	0.60	0.75	-	1.2	1.0	0.04	0.03	0.75	65	20	(c)
E430Nb	0.10	15.0-18.0	0.6	0.5	0.5-1.5	1.2	1.0	0.04	0.03	0.5	65	13	(c)

(Continued)

Class.	Chemical composition (%) <sup>(1) (2)</sup>											Mechanical properties <sup>(3)</sup>		
	C	Cr	Ni	Mo	Mn	Si	P	S	N	Cu	W	TS, Min (ksi)	El., Min. (%)	PWHT
E2209	0.04	21.0-24.0	7.5-10.0	2.5-4.0	0.5-2.0	1.0	0.04	0.03	0.08-0.20	0.5	-	100	20	None
E2307	0.04	22.5-25.5	6.5-10.0	0.8	2.0	1.0	0.03	0.02	0.10-0.20	0.50	-	100	20	None
E2553	0.04	24.0-27.0	8.5-10.5	2.9-3.9	0.5-1.5	0.75	0.04	0.03	0.10-0.25	1.5-2.5	-	110	15	None
E2594	0.04	24.0-27.0	8.0-10.5	2.5-4.5	0.5-2.5	1.0	0.04	0.03	0.20-0.30	1.5	1.0	110	15	None

Note: (1) Single values are maximum.

(2) The total of other elements, except iron, shall not present in excess of 0.50%.

(3) All-weld-metal mechanical properties are obtained after the following PWHT:

a: Heated to 1350 to 1400°F (732 to 760°C), held for 1 hour, then furnace cooled to 600°F (315°C) at a rate not to exceed 100°F (55°C) per hour, then cooled in air to room temperature.

b: Heated to 1100 to 1150°F (593 to 621°C), held for 1 hour, then cooled in air to room temperature.

c: Heated to 1400 to 1450°F (760 to 788°C), held for 4 hours, then furnace cooled to 1100°F (593°C) at a rate not to exceed 100°F (55°C) per hour, then cooled in air to room temperature.

## ② Position of welding

Code	Position
0	Flat and horizontal
1	All position

## ③ External shielding medium and related requirements

Code	External shielding medium	Welding polarity	Welding process
1	CO <sub>2</sub>	DCEP	FCAW
3	None (self-shielded)	DCEP	FCAW
4	75-80%Ar/bal. CO <sub>2</sub>	DCEP	FCAW
5	100%Argon	DCEN	GTAW

# AWS A5.34-2013

## Nickel-Alloy Electrodes for Flux Cored Arc Welding

### Classification system

ENi  T  -  [Ex.] ENi Cr3 T 0 - 4

TNi  -   [Ex.] TNi 6082 - 0 4

E: Welding electrodes

T: Tubular or flux-cored electrodes

①: Weld metal chemical and mechanical requirements

Classification		Chemical composition of all-weld metal(%) <sup>(1) (2)</sup>									
Traditional	ISO format	C	Mn	Fe	P	S	Si	Cu	Ni <sup>(3)</sup>	Co	Ti
Cr3	6082	0.10	2.5-3.5	3.0	0.03	0.015	0.50	0.50	67.0 min.	<sup>(5)</sup>	0.75
CrFe1	6062	0.08	3.5	11.0	0.03	0.015	0.75	0.50	62.0 min.	-	-
CrFe2	6133	0.10	1.0-3.5	12.0	0.03	0.02	0.75	0.50	62.0 min.	<sup>(5)</sup>	-
CrFe3	6182	0.10	5.0-9.5	10.0	0.03	0.015	1.0	0.50	59.0 min.	<sup>(5)</sup>	1.0
Mo13	1013	0.10	2.0-3.0	10.0	0.020	0.015	0.75	0.5	58.0 min.	-	-
CrMo2	6002	0.05-0.15	1.0	17.0-20.0	0.04	0.03	1.0	0.50	Bal	0.50-2.50	-
CrMo3	6625	0.10	0.5	5.0 <sup>(4)</sup>	0.02	0.015	0.50	0.50	58.0 min.	<sup>(5)</sup>	0.40
CrMo4	6276	0.02	1.0	4.0-7.0	0.03	0.03	0.2	0.50	Bal	2.5	-
CrMo10	6022	0.02	1.0	2.0-6.0	0.03	0.015	0.2	0.50	Bal	2.5	-
CrCoMo1	6117	0.05-0.15	0.3-2.5	5.0	0.03	0.015	0.75	0.50	Bal	9.0-15.0	-



①: Weld metal chemical and mechanical requirements (Continued)

Classification		Chemical composition of all-weld metal(%) <sup>(1) (2)</sup>					Mechanical properties of all-weld metal <sup>(7)</sup>	
Traditional	ISO format	Cr	Nb(Cb) + Ta <sup>(6)</sup>	Mo	V	W	TS, Min (ksi)	El., Min. (%)
Cr3	6082	18.0-22.0	2.0-3.0	-	-	-	80	25
CrFe1	6062	13.0-17.0	1.5-4.0	-	-	-	80	25
CrFe2	6133	13.0-17.0	0.5-3.0	0.5-2.5	-	-	80	25
CrFe3	6182	13.0-17.0	1.0-2.5	-	-	-	80	25
Mo13	1013	4.0-8.0	-	16.0-19.0	-	2.0-4.0	100	25
CrMo2	6002	20.5-23.0	-	8.0-10.0	-	0.2-1.0	90	25
CrMo3	6625	20.0-23.0	3.15-4.15	8.0-10.0	-	-	100	25
CrMo4	6276	14.5-16.5	-	15.0-17.0	0.35	3.0-4.5	100	25
CrMo10	6022	20.0-22.5	-	12.5-14.5	0.35	2.5-3.5	100	25
CrCoMo1	6117	21.0-26.0	1.0	8.0-10.0	-	-	90	25

(1) Single values are maximum.

(2) The total of other elements shall not present in excess of 0.50%.

(3) Includes residual cobalt.

(4) Iron is 1.0 maximum when specified by the purchaser.

(5) Cobalt is 0.10 Maximum when specified by the purchaser.

(6) Tantalum is 0.30 maximum when specified by the purchaser.

(7) As-welded condition.

② Welding position

Code	Welding position
0	Flat and horizontal fillet
1	All positions

③ Shielding gas

Code	External shielding medium
1	CO <sub>2</sub>
3	None (self-shielded)
4	75-80%Ar/bal. CO <sub>2</sub>

## Stick electrodes for manual metal arc welding of non-alloy and fine grain steels

### Classification (System A)

EN ISO 2560-A-E ① ② ③ ④ ⑤ ⑥ ⑦

[Ex.] EN ISO 2560-A-E 46 3 1Ni B 5 4 H5

E: Designates stick electrodes for manual metal arc welding

①: All-weld metal yield strength and related requirements

Code	Yield strength or 0.2% offset strength, Min. (N/mm <sup>2</sup> )	Tensile strength (N/mm <sup>2</sup> )	Elongation (L=5D) Min. (%)
35	355	440-570	22
38	380	470-600	20
42	420	500-640	20
46	460	530-680	20
50	500	560-720	18

②: Impact value of all-weld metal

Code	Test temp. (°C)	Impact absorbed energy Min. (J)
Z	Not required	Average 47
A	+20	
0	0	
2	-20	
3	-30	
4	-40	
5	-50	
6	-60	

③: Chemical composition of all-weld metal

Code	Chemical composition <sup>(1)</sup> (%)		
	Mn	Mo	Ni
No symbol	2.0	-	-
Mo	1.4	0.3-0.6	-
MnMo	1.4-2.0	0.3-0.6	-
1Ni	1.4	-	0.6-1.2
2Ni	1.4	-	1.8-2.6
3Ni	1.4	-	2.6-3.8
Mn1Ni	1.4-2.0	-	0.6-1.2
1NiMo	1.4	0.3-0.6	0.6-1.2
Z	Other elements as agreed		

Note: (1) Single values are maximums.  
 If not specified, Mo<0.2%, Ni<0.3%,  
 Cr<0.2%, V<0.05%, Nb<0.05%,  
 Cu<0.3%

④: Type of covering

Code	Type of electrode covering
A	Acid covering
C	Cellulose covering
R	Rutile covering
RR	Rutile thick covering
RC	Rutile-cellulosic covering
RA	Rutile-acid covering
RB	Rutile-basic covering
B	Basic covering

⑤: Weld metal recovery and type of current (Option)

Code	Nominal electrode efficiency $\eta$ (%)	Type of current
1	$\eta \leq 105$	AC, DC
2	$\eta \leq 105$	DC
3	$105 < \eta \leq 125$	AC, DC
4	$105 < \eta \leq 125$	DC
5	$125 < \eta \leq 160$	AC, DC
6	$125 < \eta \leq 160$	DC
7	$\eta > 160$	AC, DC
8	$\eta > 160$	DC

⑥: Welding position (Option)

Code	Designation
1	All positions
2	All positions except vertical down
3	Flat butt , flat fillet and Horizontal-vertical fillet
4	Flat butt and fillet
5	Vertical-down and those specified in the code 3

⑦: Diffusible hydrogen (Option)

Code	Diffusible hydrogen, Max. ml/100g all-weld metal
H5	5
H10	10
H15	15

# EN ISO 17632:2015

## Tubular cored electrodes for gas shielded and non-gas shielded metal arc welding of non-alloy and fine-grain steels

### Classification (System A)

EN ISO 17632-A - T

[Ex.] EN ISO 17632-A - T 46 3 1Ni B M 4 H5

T: Designates tubular cored electrodes for metal arc welding

①: Yield strength and related requirements

(a) Multiple-layer welding:

Yield strength of all-weld metal

Code	Yield strength or 0.2% offset strength Min. (N/mm <sup>2</sup> )	Tensile strength (N/mm <sup>2</sup> )	Elongation (L=5D) Min. (%)
35	355	440~570	22
38	380	470~600	20
42	420	500~640	20
46	460	530~680	20
50	500	560~720	18

(b) Single pass welding:

Yield strength of weld joint

Code	Yield strength of base metal Min. (N/mm <sup>2</sup> )	Tensile strength of weld joint Min. (N/mm <sup>2</sup> )
3T	355	470
4T	420	520
5T	500	600

②: Impact value of all-weld metal or weld joint

Code	Test temp. (°C)	Impact absorbed energy Min. (J)
Z	Not required	Average 47
A	+20	
0	0	
2	-20	
3	-30	
4	-40	
5	-50	
6	-60	

③: Chemical composition of all-weld metal

Code	Chemical composition <sup>(1)</sup> (%)		
	Mn	Ni	Mo
-	2.0	-	-
Mo	1.4	-	0.3-0.6
MnMo	1.4~2.0	-	0.3-0.6
1Ni	1.4	0.6-1.2	-
1.5Ni	1.6	1.2-1.8	-
2Ni	1.4	1.8-2.6	-
3Ni	1.4	2.6-3.8	-
Mn1Ni	1.4~2.0	0.6-1.2	-
1NiMo	1.4	0.6-1.2	0.3-0.6
Z	Other elements as agreed		

Note: (1) Single values are maximum.

Where no specification, Mo<0.2%, Ni<0.5%, Cr<0.2%, V<0.08%, Nb<0.05%, Cu<0.3%, and for non-gas shielded wires, Al<2.0%.

④: Type of cored flux

Code	Features	Type of welding	Shielding gas
R	Rutile, Slow-freezing slag	Single pass or multiple pass	Required
P	Rutile, Fast-freezing slag		
B	Basic		
M	Metal powder		
V	Rutile or basic / Fluorides	Single pass	Not required
W	Basic / Fluorides, Slow-freezing slag	Single pass or multiple pass	
Y	Basic / Fluorides, Fast-freezing slag		
Z	Other types		

⑥: Welding position (Option)

Code	Designation
1	All positions
2	All positions except vertical downward
3	Flat butt and fillet, Horizontal fillet
4	Flat butt and fillet
5	Vertical downward and those specified in the code 3

⑤: Shielding gas

Code	Designation
M	Gas mixtures (Gases specified as M2 per EN 439, excepting He)
C	CO <sub>2</sub> (Gases specified as C1 per EN 439)
N	Non-gas shielded

⑦: Diffusible hydrogen (Option)

Code	Diffusible hydrogen, Max. ml/100g deposited metal
H5	5
H10	10
H15	15

# EN ISO 18276:2006

## Tubular cored electrodes for gas-shielded and non-gas shielded metal arc welding of high-strength steels

### Classification (System A)

EN ISO 18276-A - T 1 2 3 4 5 6 7 8

[Ex.] EN ISO 18276-A - T 55 5 Mn1,5Ni B M 4 H5 T

T: Designates tubular cored electrodes for gas-shielded and non-gas shielded metal arc welding

①: All-weld metal yield strength and related requirements

Code	Yield point or 0.2% offset strength, Min. (N/mm <sup>2</sup> )	Tensile strength (N/mm <sup>2</sup> )	Elongation (L=5D) (%)
55	550	640-820	18
62	620	700-890	18
69	690	770-940	17
79	790	880-1080	16
89	890	940-1180	15

②: Impact value of all-weld metal

Code	Absorbed energy of 47J, Three-specimen average, <sup>(1)</sup> Test temp. (°C)
Z	Not specified
A	+20
0	0
2	-20
3	-30
4	-40
5	-50
6	-60

Note: (1) One value can be lower than 47J but shall be 32J or higher

③: Chemical composition of all-weld metal

Code	Chemical composition (%) <sup>(1)</sup>			
	Mn	Ni	Cr	Mo
Z	Elements as agreed			
MnMo	1.4-2.0	-	-	0.3-0.6
Mn1Ni	1.4-2.0	0.6-1.2	-	-
Mn1, 5Ni	1.1-1.8	1.3-1.8	-	-
Mn2, 5Ni	1.1-2.0	2.1-3.0	-	-
1NiMo	1.4	0.6-1.2	-	0.3-0.6
1, 5NiMo	1.4	1.2-1.8	-	0.3-0.7
2NiMo	1.4	1.8-2.6	-	0.3-0.7
Mn1NiMo	1.4-2.0	0.6-1.2	-	0.3-0.7
Mn2NiMo	1.4-2.0	1.8-2.6	-	0.3-0.7
Mn2NiCrMo	1.4-2.0	1.8-2.6	0.3-0.6	0.3-0.6
Mn2Ni1CrMo	1.4-2.0	1.8-2.6	0.6-1.0	0.3-0.6

Note: (1) Single values are maximum.

⑥: Welding position

Code	Designation
1	All positions
2	All positions except vertical downward
3	Flat butt and fillet, Horizontal fillet
4	Flat butt and fillet
5	Vertical downward and those in Code 3

④: Type of flux

Code	Features
R	Rutile, Slow-freezing slag
P	Rutile, Fast-freezing slag
B	Basic
M	Metal powder
Z	Others

⑤: Shielding gas

Code	Designation
M	Gas mixtures
C	CO <sub>2</sub>

⑦: Diffusible hydrogen

Code	Diffusible hydrogen, Max. ml/100g deposited metal
H5	5
H10	10

⑧: Heat treatment: T: 560-600°C × 1h, FC to 300°C for mechanical tests of all-weld metal

# EN ISO 17634:2015

## Tubular cored electrodes for gas shielded metal arc welding of creep-resisting steels

### Classification (System A)

EN ISO 17634-A - T ① ② ③ ④ ⑤

[Ex.] EN ISO 17634-A - T CrMo1 B M 4 H5

T: Designates tubular cored electrodes for gas shielded metal arc welding

①: Chemical composition and mechanical properties of all-weld metal

Chemical composition of all-weld metal

Code	Chemical composition (%)		
	Cr	Mo	V
Mo	-	0.40-0.65	-
MoL	-	0.40-0.65	-
MoV	0.30-0.60	0.50-0.80	0.25-0.45
CrMo1	0.90-1.40	0.40-0.65	-
CrMo1L	0.90-1.40	0.40-0.65	-
CrMo2	2.00-2.50	0.90-1.30	-
CrMo2L	2.00-2.50	0.90-1.30	-
CrMo5	4.00-6.00	0.40-0.70	-
Z	Elements as agreed		

②: Type of flux

Code	Features
R	Rutile, Slow-freezing slag
P	Rutile, Fast-freezing slag
B	Basic
M	Metal powder
Z	Other types

③: Shielding gas

Code	Designation
M	Gas mixtures (Gases specified as M2 per EN 439, excepting He)
C	CO <sub>2</sub> (Gases specified as C1 per EN 439)

⑤: Diffusible hydrogen (Option)

Code	Diffusible hydrogen, Max. ml/100g deposited metal
H5	5
H10	10

④: Welding position (Opt.)

Code	Designation
1	All positions
2	All positions except vertical downward
3	Flat butt and fillet, Horizontal fillet
4	Flat butt and fillet
5	Vertical downward and those in Code 3

Mechanical properties of all-weld metal

Code	Proof strength, Min. Rp0.2 (N/mm <sup>2</sup> )	Tensile strength, Min. Rm (N/mm <sup>2</sup> )	Elongation (L=5D) Min. A (%)	Absorbed energy Kv (J) +20°C		Heat treatment of all-weld metal		
				Average of three values, Min. (J)	Single value, Min. (J)	Preheat and interpass temp. (°C)	PWHT	
							Temp. <sup>(1)</sup> (°C)	Time (min)
Mo/MoL	355	510	22	47	38	<200	570-620	60±10
MoV	355	510	18	47	38	200-300	690-730	60±10
CrMo1	355	510	20	47	38	150-250	660-700	60±10
CrMo1L	355	510	20	47	38	150-250	660-700	60±10
CrMo2	400	500	18	47	38	200-300	690-750	60±10
CrMo2L	400	500	18	47	38	200-300	690-750	60±10
CrMo5	400	590	17	47	38	200-300	730-760	60±10
Z	Mechanical properties as agreed							

Note (1) Cooling speed: 200°C/1h max. to 300°C by FC

# EN ISO 17633:2010

## Tubular cored electrodes and rods for gas shielded and non-gas shielded metal arc welding of stainless and heat-resisting steels

### Classification (System A)

EN ISO 17633-A - T ① ② ③ ④ [Ex.] EN ISO 17633-A - T 19 12 3L R M 4

T: Designates tubular cored electrodes for gas shielded and non-gas shielded metal arc welding

①: chemical composition and mechanical properties of all-weld metal

Classification	Chemical composition (%)				Proof strength Min. Rp0.2 (N/mm <sup>2</sup> )	Tensile strength Min. Rm (N/mm <sup>2</sup> )	El. Min. A (L=5D) %	PWHT
	Cr	Ni	Mo	Others				
Martensite/ferrite type								
13	11.0-14.0	-	-	-	250	450	15	(3)
13 Ti	10.5-13.0	-	-	Ti (1)	250	450	15	(3)
13 4	11.0-14.5	3.0-5.0	0.4-1.0	-	500	750	15	(4)
17	16.0-18.0	-	-	-	300	450	15	(5)
Austenite type								
19 9 L	18.0-21.0	9.0-11.0	-	-	320	510	30	None
19 9 Nb	18.0-21.0	9.0-11.0	-	Nb (2)	350	550	25	None
19 12 3 L	17.0-20.0	10.0-13.0	2.5-3.0	-	320	510	25	None
19 12 3 Nb	17.0-20.0	10.0-13.0	2.5-3.0	Nb (2)	350	550	25	None
19 13 4 N L	17.0-20.0	12.0-15.0	3.0-4.5	N: 0.08-0.20	350	550	25	None
Austenite-ferrite high corrosion resistant type								
22 9 3 N L	21.0-24.0	7.5-10.5	2.5-4.0	N: 0.08-0.20	450	550	20	None
Full-austenite high corrosion resistant type								
18 16 5 N L	17.0-20.0	15.5-19.0	3.5-5.0	N: 0.08-0.20	300	480	25	None
Special type								
18 8 Mn	17.0-20.0	7.0-10.0	-	-	350	500	25	None
20 10 3	19.5-22.0	9.0-11.0	2.0-4.0	-	400	620	20	None
23 12 L	22.0-25.0	11.0-14.0	-	-	320	510	25	None
23 12 2 L	22.0-25.0	11.0-14.0	2.0-3.0	-	350	550	25	None
29 9	27.0-31.0	8.0-12.0	-	-	450	650	15	None
Heat resistant type								
22 12 H	20.0-23.0	10.0-13.0	-	-	350	550	25	None
25 20	23.0-27.0	18.0-22.0	-	-	350	550	20	None

Note: (1) Ti :10°C%-1.5%

(2) Nb:8°C%-1.1%: Nb can be replaced with Ta up to 20%

(3) 840-870°C × 2h heating, followed by FC to 600°C and later AC

(4) 580-620°C × 2h heating, followed by AC

(5) 760-790°C × 2h heating, followed by FC to 600°C and later AC



②: Type of flux

Code	Features
R	Rutile, Slow-freezing slag
P	Rutile, Fast-freezing slag
M	Metal powder
U	Self-shielded
Z	Other types

③: Shielding gas

Code	Designation
M	Gas mixtures (Gases specified as M2 per EN 439, excepting He)
C	CO <sub>2</sub> (Gases specified as C1 per EN 439)
N	Self-shielded

④: Welding position (Option)

Code	Designation
1	All positions
2	All positions except vertical downward
3	Flat butt and fillet, and horizontal fillet
4	Flat butt and fillet
5	Vertical downward and those in Code 3





# **Alphabetical Index**

---

## Alphabetical Index

- Note: • (HT): For high tensile strength steel  
 • (HR): For heat-resistant low-alloy steel  
 • SAW flux-wire combinations can be accessed from either flux or wire.

<b>A</b>		<b>D</b>			
AF-490AS/US-36	92	DW-50	64	DW-317L	302
AF-490E/US-29	90	DW-50LSR	147	DW-317LP	303
AF-490SP/US-36	91	DW-50W	99	DW-329AP	306
<b>B</b>		DW-55E	131	DW-347	304
B-10	36	DW-55L	134	DW-410Cb	309
B-14	37	DW-55LSR	135	DW-460L	150
B-17	38	DW-62L	141	DW-588	98
B-33	33	DW-100	65	DW-2209	305
BL-96	186	DW-100E	67	DW-2307	307
BL-106	187	DW-100ES	130	DW-2594	308
<b>C</b>		DW-100KS	130	DW-A50	68
CI-A1	360	DW-100V	66	DW-A51B	69
CI-A2	360	DW-200	58	DW-A55E	132
CI-A3	360	DW-308	282	DW-A55ESR	133
CM-2CW	201	DW-308H	277	DW-A55L	137
CM-9Cb	204	DW-308L	278	DW-A55LSR	138
CM-95B91	202	DW-308L-XR	283	DW-A62L	142
CM-96B91	203	DW-308LH	280	DW-A62LSR	143
CM-A76	188	DW-308LP	281	DW-A65Ni1	140
CM-A96	189	DW-308LP-XR	284	DW-A70L	148
CM-A96MB	190	DW-308LT	279	DW-A80L	149
CM-A96MBD	191	DW-309	290	DW-A81Ni1	139
CM-A106	194	DW-309L	287	DW-H11	354
CM-A106H	199	DW-309L-XR	291	DW-H16	354
CM-A106HD	200	DW-309LH	288	DW-H250	352
CM-A106N	195	DW-309LP	289	DW-H350	352
CM-A106ND	196	DW-309LP-XR	292	DW-H450	352
CM-B95	192	DW-309MoL	285	DW-H600	352
CM-B98	193	DW-309MoLP	286	DW-H700	352
CM-B105	197	DW-310	293	DW-H800	352
CM-B108	198	DW-312	294	DW-N82	372
CR-12S	205	DW-316H	299	DW-N625	373
CR-40	273	DW-316L	295	DW-N709SP	375
CR-40Cb	272	DW-316L-XR	300	DW-NC276	374
		DW-316LH	297	DW-S1LG	386
		DW-316LP	298	DW-S43G	386
		DW-316LP-XR	301	DW-S60G	386
		DW-316LT	296		

<b>F</b>		
FA-B1/MF-38/ US-36/RR-2	384	
FA-B1/MF-38/ US-49/RR-2	384	
FA-B1/PF-I52E/ US-36/RR-2	384	

<b>G</b>		
G-50/US-36	84	
G-60/US-36	85	
G-80/US-36	86	
G-80/US-B2	239	

<b>H</b>		
HF-11	350	
HF-12	350	
HF-13	350	
HF-16	350	
HF-30	350	
HF-240	344	
HF-260	344	
HF-330	344	
HF-350	344	
HF-450	346	
HF-500	346	
HF-600	346	
HF-650	346	
HF-700	348	
HF-800K	348	
HF-950	348	

<b>K</b>		
KOBE-6010	32	
KOBE-7010S	49	
KOBE-8010S	50	

<b>L</b>		
LB-26	39	
LB-52	40	
LB-52-18	45	
LB-52A	41	

LB-52NS	114	
LB-52NSU	115	
LB-52T	47	
LB-52U	42	
LB-55NS	116	
LB-55U	43	
LB-57	44	
LB-62	118	
LB-62D	122	
LB-62L	112	
LB-62U	120	
LB-62UL	119	
LB-65L	113	
LB-67L	121	
LB-7018-1	110	
LB-70L	125	
LB-76	52	
LB-78VS	48	
LB-80L	129	
LB-80UL	127	
LB-88LT	128	
LB-88VS	53	
LB-98VS	54	
LB-106	123	
LB-116	126	
LB-8018	51	
LB-W52	96	
LB-W52B	97	
LB-Y75	124	
LT-B50	55	
LT-B52A	46	

<b>M</b>		
MF-29A/US-2CW	244	
MF-38/US-36	88	
MF-38/US-36/ RR-2/FA-B1	384	
MF-38/US-40 (HT)	171	
MF-38/US-40 (HR)	236	
MF-38/US-49 (HT)	172	
MF-38/US-49 (HR)	235	
MF-38/US-49/ RR-2/FA-B1	384	

MF-38/US-49A	166
MF-38/US-A4 (HT)	170
MF-38/US-A4 (HR)	234
MF-38/US-W52B	102
MF-53/US-36	83
MF-53/US-W52B	101
MF-300/US-36	89
MG-50	72
MG-50T	76
MG-51T	71
MG-60	154
MG-70	156
MG-80	158
MG-S1CM	210
MG-S1N	152
MG-S2CM	212
MG-S2CW	213
MG-S3N	153
MG-S9Cb	215
MG-S12CRS	216
MG-S50	73
MG-S50LT	151
MG-S56	206
MG-S63B	155
MG-S63S	207
MG-S70	157
MG-S70NCb	376
MG-S70SA1	208
MG-S80	159
MG-S80B2F	211
MG-S88A	160
MG-S90B91	214
MG-S308	317
MG-S308LS	318
MG-S309	319
MG-S309LS	320
MG-S316LS	321
MG-SM	209
MG-W50TB	100
MIX-1TS	77
MIX-50	70
MIX-50S	74
MX-55LF	136
MX-100	59



---

**U**

---

US-2CW/MF-29A	244
US-2N/PF-H55S	173
US-2N/PF-H62AK	175
US-2N/PF-H62AS	174
US-9Cb/PF-200S	247
US-12CRSD/PF-200S	248
US-29/AF-490E	90
US-36/AF-490AS	92
US-36/AF-490SP	91
US-36/G-50	84
US-36/G-60	85
US-36/G-80	86
US-36/MF-38	88
US-36/MF-53	83
US-36/MF-300	89
US-36/PF-H55E	87
US-36/PF-H55LT	167
US-36/PF-I50R/ PF-I55E	382
US-36/RR-2/ FA-B1/MF-38	384
US-36/RR-2/ FA-B1/PF-I52E	384
US-36J/PF-H55AS	168
US-40/MF-38 (HT)	171
US-40/MF-38 (HR)	236
US-49/MF-38 (HT)	172
US-49/MF-38 (HR)	235
US-49/RR-2/ FA-B1/MF-38	384
US-49A/MF-38	166
US-56B/PF-200	232
US-63S/PF-200	233
US-80LT/PF-H80AK	177
US-80LT/PF-H80AS	176
US-90B91/PF-90B91	246
US-90B91/PF-200S	245
US-203E/PF-H203	169
US-511N/PF-200	237
US-511ND/PF-200D	238
US-521H/PF-500	243
US-521S/PF-200	241

US-521S/PF-200D	242
US-709S/PF-N4	380
US-2209/PF-S1D	338
US-A4/MF-38 (HT)	170
US-A4/MF-38 (HR)	234
US-B2/G-80	239
US-B2R/PF-200D	240
US-W52B/MF-38	102
US-W52B/MF-53	101

---

**Z**

---

Z-44	35
------	----

---

Planning and Editing: Marketing Planning Section, Marketing Department  
Welding Business, Kobe Steel, Ltd.

Issue: KOBE STEEL, LTD., Welding Business Marketing Department

Design and Printing: FUKUDA PRINTING CO., LTD.

---





# **KOBELCO**

---

**The Worldwide Manufacturer**